



# **S** SD9362-EH-v2 Speed Dome Network Camera

1080p 60fps • 30x Zoom • WDR Pro • NEMA 4X •  
IP68 • IK10 • -40°C ~ 55°C

VIVOTEK's SD9362-EH-v2 is a high-performance H.265 Full HD speed dome network camera. Armed with a 30x optical zoom lens, the camera is able to capture fine details at top-notch quality. By combining both H.265 and VIVOTEK's Smart Stream II technology which enables the camera to optimize quality for desired regions and therefore to maximize efficiency of bandwidth usage, it is capable of reducing both bandwidth and storage consumption by up to 80%\* while maintaining the highest standard of image quality.

Offering extra smooth video quality with resolutions of up to 60 fps at 1920x1080, the SD9362-EH-v2 is also equipped with WDR Pro technology and IR-cut filter for seamless day/night

operation. This enables the camera to cope effortlessly with the challenging lighting conditions faced in 24/7 surveillance. Further, the water-proof IP68-rated, vandal-proof IK10-rated and NEMA 4X-rated housing of the SD9362-EH-v2 protects the camera body against rain, dust and corrosion and provides a wide operating-temperature range of between -40°C and 55°C. This combination of robustness and high performance ensures that the SD9362-EH-v2 is especially suitable for monitoring wide, open, harsh indoor or outdoor spaces such as airports, highways and parking lots where high-level reliability and precision are called for.

\* Depending on scene being monitored

## Key Features

- H.265 Compression technology
- 1080P Full HD CMOS Sensor
- 60 fps @ 1080p Full HD
- 30x Zoom Lens
- 360° Continuous Pan and 220° Tilt
- Removable IR-cut Filter for Day & Night Function
- WDR Pro for Unparalleled Visibility in High Contrast Environments
- Smart Stream II to Optimize Bandwidth Efficiency
- Weather-proof IP68-rated, Vandal-proof IK10 and NEMA 4X-rated Housing
- -40°C ~ 55°C Wide Temperature Range for Extreme Weather Conditions
- EIS (Electronic Image Stabilization) to Control Image Stability

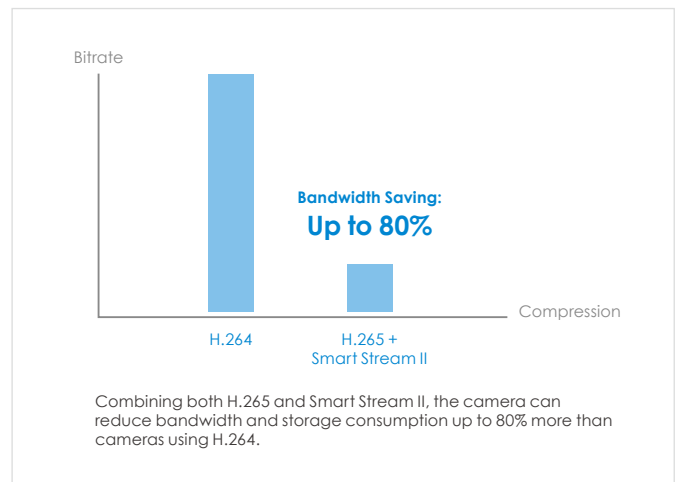

## Technical Specifications

Model	SD9362-EH-v2
<b>System Information</b>	
CPU	Multimedia SoC (System-on-Chip)
Flash	128MB
RAM	512MB
<b>Camera Features</b>	
Image Sensor	1/2.8" Progressive CMOS
Max. Resolution	1920x1080 (2MP)
Lens Type	30x Optical Zoom, Auto Focus
Focal Length	f = 4.3 ~ 129 mm (30x zoom)
Aperture	F1.6 ~ F4.7
Iris Type	DC-iris
Field of View	2.3° ~ 64° (Horizontal) 1.3° ~ 36° (Vertical) 2.6° ~ 73° (Diagonal)
Shutter Time	1 sec. to 1/10,000 sec.
WDR Technology	WDR Pro
Day/Night	Yes
Removable IR-cut Filter	Yes
Minimum Illumination	0.195 Lux @ F1.6 (Color) 0.01 Lux @ F1.6 (B/W)
Pan Speed	0.05° ~ 450° / sec.
Pan Range	360° endless
Tilt Speed	0.05° ~ 450° / sec.
Tilt Range	220° (-110° ~ +110°)
Preset Locations	256 preset locations 128 presets per tour
Pan/Tilt/Zoom Functionalities	48x digital zoom (4x on IE plug-in, 12x built-in), Auto pan mode, Auto patrol mode
On-board Storage	Slot type: MicroSD/SDHC/SDXC card slot Seamless Recording
<b>Video</b>	
Compression	H265, H264, MJPEG
Maximum Frame Rate	H.265 & H.264: 60 fps @ 1920x1080 MJPEG: 30 fps @ 1920x1080
Maximum Streams	4 simultaneous streams
S/N Ratio	66 dB
Dynamic Range	130 dB
Video Streaming	Adjustable resolution, quality and constant bit rate control, Smart Stream II
Image Settings	Time stamp, text overlay, flip and mirror, configurable brightness/contrast/saturation/sharpness, white balance, exposure control, gain, backlight compensation, privacy masks (Up to 24), scheduled profile settings, defog, 3DNR, EIS, HLC
<b>Audio</b>	
Audio Capability	Two-way Audio (full duplex)

Compression	G.711, G.726
Interface	External microphone input External line output
<b>Network</b>	
Users	Live viewing for up to 10 clients
Protocols	802.1X, ARP, CIFS/SMB, CoS, DDNS, DHCP, DNS, FTP, HTTP, HTTPS, ICMP, IGMP, IPv4, IPv6, NTCIP, NTP, PPPoE, QoS, RTSP/RTP/RTCP, SMTP, SNMP, SSL, TCP/IP, TLS, UDP, UPnP
Interface	10 Base-T/100 Base-TX Ethernet (RJ-45) *It is highly recommended to use standard CAT5e & CAT6 cables which are compliant with the 3P/ETL standard.
ONVIF	Supported, specification available at <a href="http://www.onvif.org">www.onvif.org</a>
<b>Intelligent Video</b>	
Video Motion Detection	Five-window video motion detection
Auto-Tracking	Auto-tracking on moving object
VADP Package	Genetec package, Amazon Kinesis Video Streams
<b>Alarm and Event</b>	
Alarm Triggers	Motion detection, manual trigger, digital input, periodical trigger, system boot, recording notification, audio detection, SD card life expectancy
Alarm Events	Event notification via digital output, email, HTTP, FTP, NAS server, SD card File upload via email, HTTP, FTP, NAS server, SD card
<b>General</b>	
Connectors	RJ-45 cable connector for Network 10/100Mbps PoE connection*1 Audio input*1 Audio output*1 AC/DC 24V power input*1 Digital input*4 Digital output*2 RS-485 for PTZ control (PelcoD protocol, Baud rate 2400)*1
LED Indicator	System power and status indicator
Power Input	UPoE (60W) AC/DC 24V
Power Consumption	PoE: Max. 48/26 W (Heater on/off) AC/DC 24V: Max. 40/21 W(Heater on/off)
Dimensions	Ø 162 x 221 mm
Weight	4.35 kg (with bracket) 2.95 kg (without bracket)
Casing	IP68, IK10, NEMA 4X
Safety Certifications	CE, FCC Class A, VCCI, C-Tick, UL
Operating Temperature	Starting Temperature: -40°C ~ 55°C (-40°F ~ 131°F) Working Temperature: -40°C ~ 55°C (-40°F ~ 131°F)
Humidity	98%
Warranty	36 months
<b>System Requirements</b>	

## Technical Specifications

Operating System	Microsoft Windows 8/7 Mac 10.12 (Chrome only)
Web Browser	Chrome 58.0 or above Internet Explorer 10/11
Other Players	VLC: 1.1.11 or above QuickTime: 7 or above







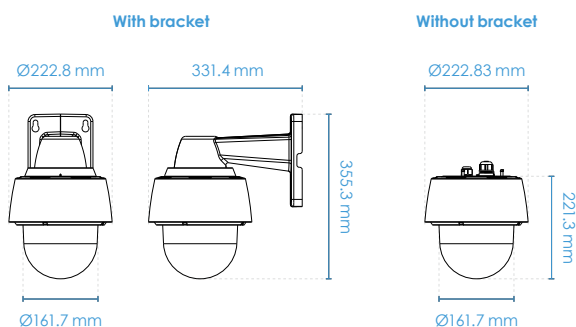







### Included Accessories

Others	Wall mount bracket, I/O combo cable, screws, waterproof connectors, quick installation guide, alignment sticker, L-wrench, desiccant bags
--------	---

### Dimensions



## Compatible Accessories

Mounting Kits			Others		
					
AM-10E Recessed kit	AM-220 Wall Mount Bracket (standard package)	AM-529 Mounting Adapter	AJ-001 USB Joystick	AJ-002 USB Joystick	AO-003 I/O Combo Cables
Cabinet					
					
AT-CAS-001 Cabinet for Speed Dome	AT-CAB-002 Cabinet for HLG Power Supply	AT-SUN-002 Sunshield	AT-SWH-000 Power Safety Kit		
PoE Kit/Power Adapter					
24VDC		24VAC			
					
HLG-80H-24 Industrial 24VDC/80W Power Supply		AA-351 Outdoor Power Box, 24VAC/144W, IP67, IK10		AA-352 Outdoor Power Box, 24VAC/144W, IP67, IK10	

## Compatible Accessories

### PoE Kit/Power Adapter

#### 60W UPoE



**AW-IHU-0100**  
Industrial 1xGE 60W UPoE Injector

**HLG-80H-54**  
Industrial 54VDC/80W Power Supply



**AW-IHU-0200**  
Industrial 1xGE 60W UPoE + 1x SFP GE Switch

**HLG-80H-54**  
Industrial 54VDC/80W Power Supply



**AP-GIC-011A-060**  
60W PoH/PoE Injector with Surge Protection 12KV



**AP-GIC-015B-095**  
Outdoor 1xGE 95W PoH/PoE Injector with Surge Protection 12KV, IP67, IK10