



YLI ELECTRONIC



Magnetic Lock(280kg)

Specification

Model	Size(unit:mm)	Voltage	Current	Holding Force	Lock Signal	Door Signal	Door
YM-280N	250Lx48.8Wx27.9H	DC12V(Default); DC24V(Order)	12V/520mA 24V/260mA	280kg(600Lbs)	No	No	Single Door
YM-280N(LED)	250Lx48.8Wx27.9H	DC12V(Default); DC24V(Order)	12V/520mA 24V/260mA	280kg(600Lbs)	NO/NC/COM	No	Single Door
YM-280NT(LED)	250Lx48.8Wx27.9H	DC12V(Default); DC24V(Order)	12V/520mA 24V/260mA	280kg(600Lbs)	NO/NC/COM	No	Single Door
YM-280N(LED)-DS	250Lx48.8Wx27.9H	DC12V(Default); DC24V(Order)	12V/520mA 24V/260mA	280kg(600Lbs)	NO/NC/COM	NO/NC/COM	Single Door
YM-280ND	500Lx48.8Wx27.9H	DC12V(Default); DC24V(Order)	12V/520mAx2 24V/260mAx2	280kgx2(600Lbsx2)	No	No	Double Door
YM-280ND(LED)	500Lx48.8Wx27.9H	DC12V(Default); DC24V(Order)	12V/520mAx2 24V/260mAx2	280kgx2(600Lbsx2)	NO/NC/COM	No	Double Door
YM-280NTD(LED)	500Lx48.8Wx27.9H	DC12V(Default); DC24V(Order)	12V/520mAx2 24V/260mAx2	280kgx2(600Lbsx2)	NO/NC/COM	No	Double Door
YM-280ND(LED)-DS	500Lx48.8Wx27.9H	DC12V(Default); DC24V(Order)	12V/520mAx2 24V/260mAx2	280kgx2(600Lbsx2)	NO/NC/COM	NO/NC/COM	Double Door

Diagram(unit:mm)

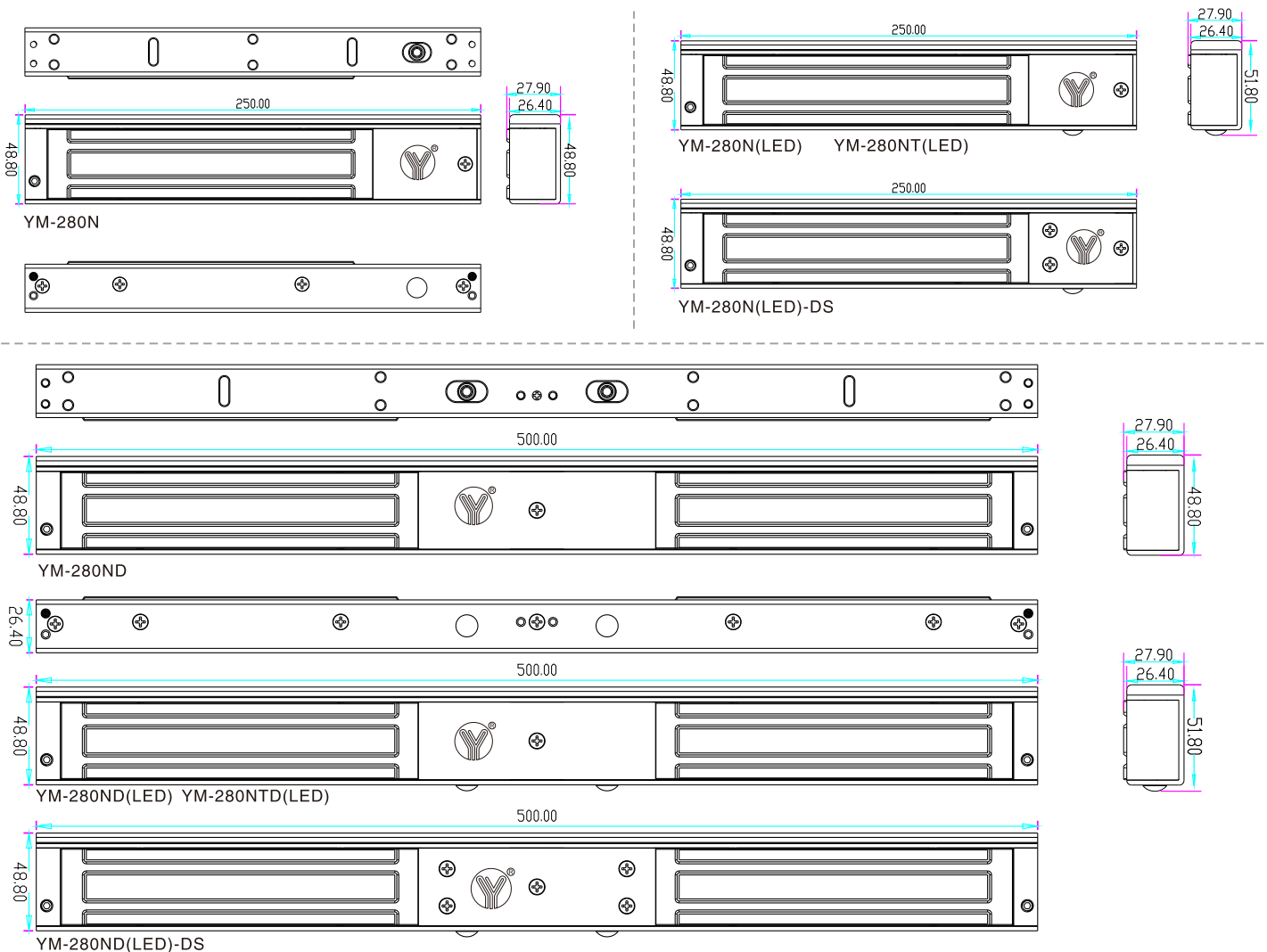

Installation

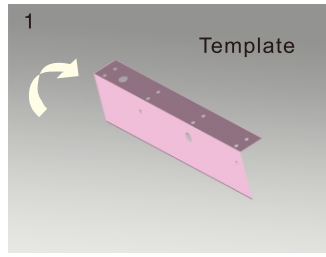
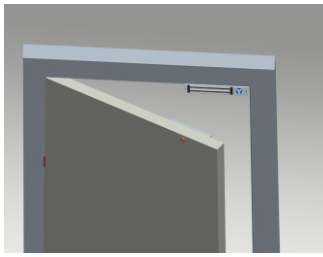

1 Fold the plate to 90° .

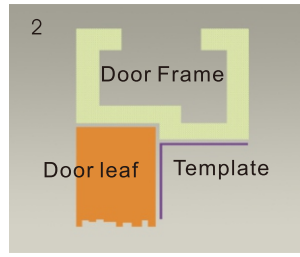

2 Close the door first, then place the upper side of template on door frame, while adjust the left side next to the door leaf.

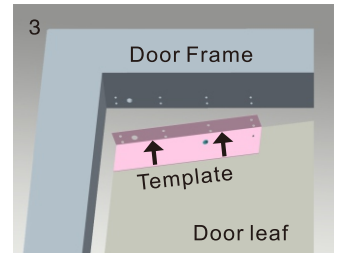

3 Mark screw positions of armature plate and magnetic lock on door leaf and door frame respectively.

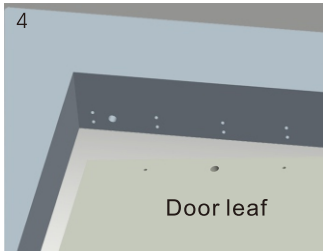

4 Drill holes based on the marked positions.

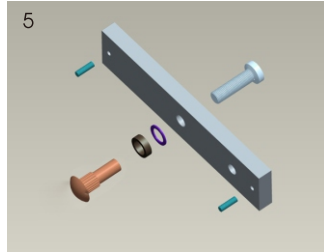

5 Make a combination based on the picture.

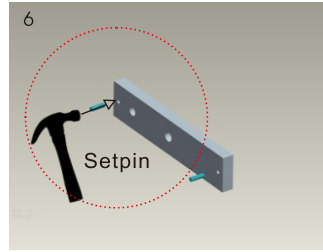

6 Strike the pin into the armature plate slightly (to avoid movement).

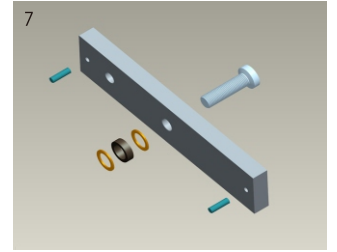

7 Make a combination based on the picture (add washer accordingly). The rubber ring must be added.

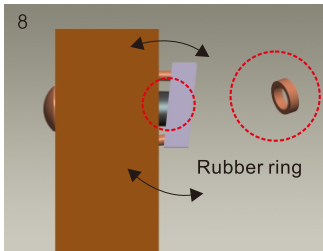

8 Place the rubber ring between armature plate and door leaf.

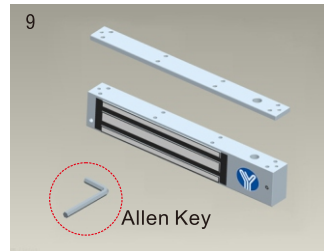

9 Use Allen key to remove the mounting plate from lock body.

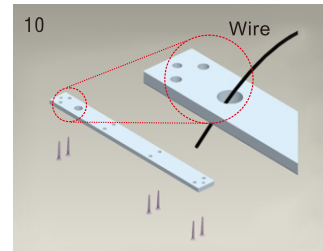

10 Fix the mounting plate on the door frame according to the holes drilled earlier.

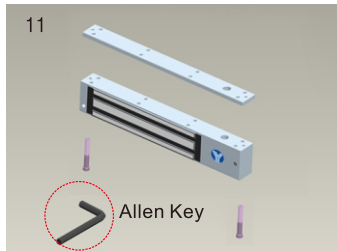

11 Use Allen key to screw the lock body on the mounting plate.

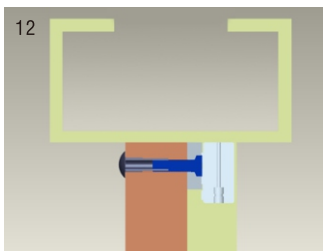

12 Close the door to test holding force. The angle between armature plate and magnetic lock can be adjusted by adding or reducing washers.

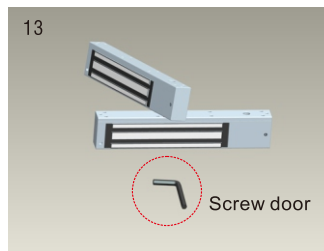

13 After all the appropriate procedures, the holding force can be maximized. Finally, fix the tamper screw.

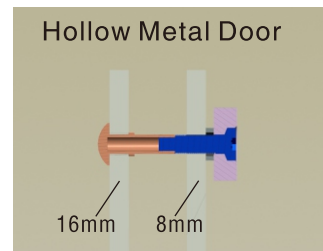

Hollow Metal Door

Drill a hole
Inside: Diameter is 8mm
Outside: Diameter is 16mm

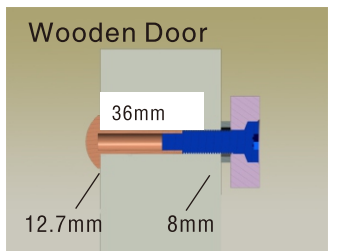

Wooden Door

Drill a hole
Inside: Diameter is 8mm
Outside: Diameter is 12.7mm

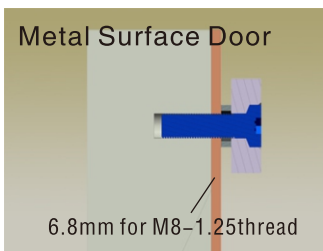

Metal Surface Door

Inside: Drill a hole diameter is 8mm folding the plastic straight pin

⚠ Notice:

Thickness of Door Leaf:

350LBS: 44mm 600LBS: 50mm 800LBS: 48mm 1200LBS: 46mm

- A. The screw of armature plate should not be fixed too tight. Proper elasticity should be guaranteed for the rubber ring so that the armature plate can adjust itself to the appropriate position.
- B. Check the jumper's position before connecting. Figure out it represents 12VDC or 24VDC.

Bracket Installation

Different brackets are available according to different types of doors. For example, narrow door, frameless glass door and inward opening door.

L Bracket-For outward opening door

When the door frame thickness is less than 42mm, L bracket is needed.

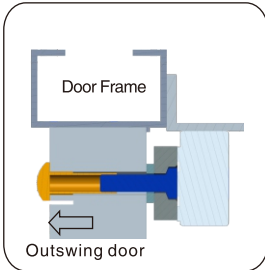

ZL Bracket-For inward opening door

For inward opening door, ZL bracket is needed.

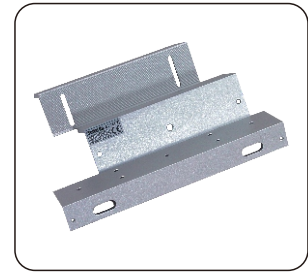
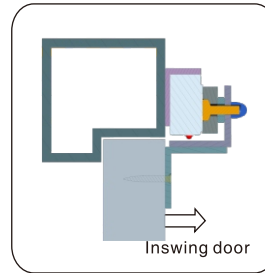

U Bracket

For the frameless glass door. U bracket is needed.

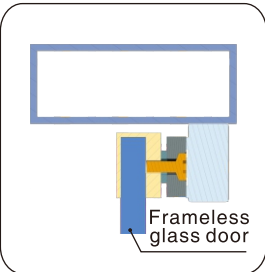

I Bracket for armature plate

When the door frame is too thick, I bracket is needed.

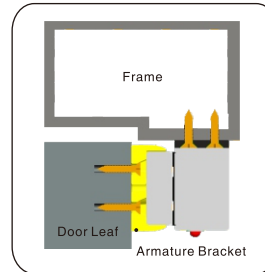

Installation Instruction

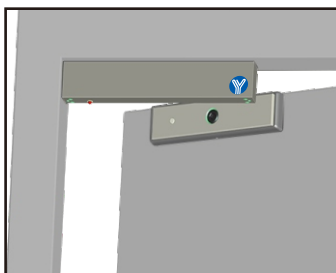

Demonstration of I Bracket Installation

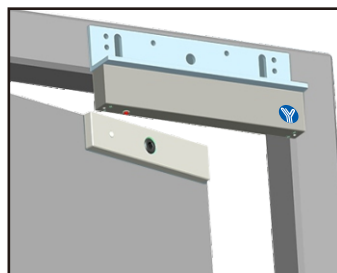

Demonstration of L Bracket Installation

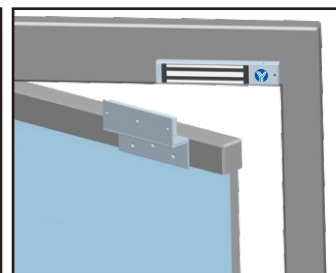

Demonstration of ZL Bracket Installation

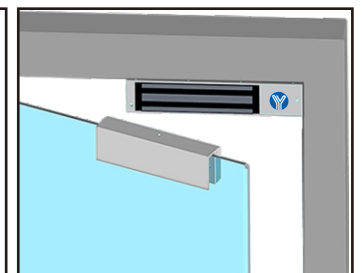

Demonstration of U Bracket Installation

Circuit Board Diagram

A. 12VDC Input:

Connect the positive(+)lead from a 12VDC power source to V +.
Connect the ground(-)lead from a 12VDC power source to V -.
Check jumper for 12 VDC operation.

B. 24VDC Input:

Connect the positive(+)lead from a 24VDC power source to V +.
Connect the ground(-)lead from a 24VDC power source to V -.
Check jumper for 24 VDC operation.

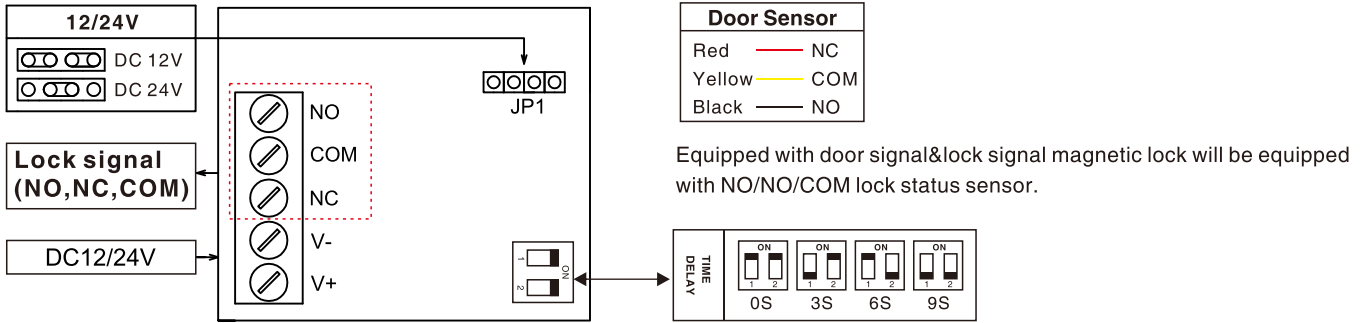

Connection: green wire or white plug, except the models without LED indicator and signal output; only when it detects that double doors have been locked, there will be normal signal output.

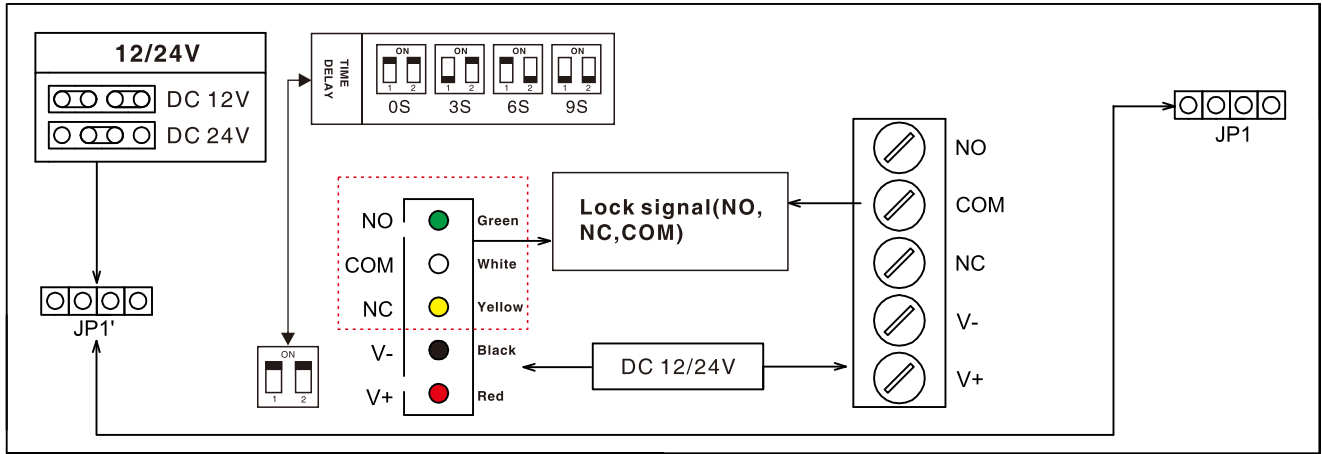

Wire Connection

