

User Manual

ZK-IWB Series

Date: April 2022

Doc Version: 1.0

English

Thank you for choosing our product. Please read the instructions carefully before operation. Follow these instructions to ensure that the product is functioning properly. The images shown in this manual are for illustrative purposes only.



For further details, please visit our Company's website
www.zkteco.com.

Copyright © 2022 ZKTECO CO., LTD. All rights reserved.

Without the prior written consent of ZKTeco, no portion of this manual can be copied or forwarded in any way or form. All parts of this manual belong to ZKTeco and its subsidiaries (hereinafter the "Company" or "ZKTeco").

Trademark

ZKTeco is a registered trademark of ZKTeco. Other trademarks involved in this manual are owned by their respective owners.

Disclaimer

This manual contains information on the operation and maintenance of the ZKTeco equipment. The copyright in all the documents, drawings, etc. in relation to the ZKTeco supplied equipment vests in and is the property of ZKTeco. The contents hereof should not be used or shared by the receiver with any third party without express written permission of ZKTeco.

The contents of this manual must be read before starting the operation and maintenance of the supplied equipment. If any of the content(s) of the manual seems unclear or incomplete, please contact ZKTeco before starting the operation and any information contained in this manual or any of the amendments made thereto. ZKTeco does not extend the warranty of any kind, including, without limitation, any warranty of design, merchantability, or fitness for a particular purpose. ZKTeco does not assume responsibility for any errors or omissions in the information or documents which are referenced by or linked to this manual. The entire risk as to the results and performance obtained from using the information is assumed by the user.

ZKTeco in no event shall be liable to the user or any third party for any incidental, consequential, indirect, special, or exemplary damages, including, without limitation, loss of business, loss of profits, business interruption, loss of business information or any pecuniary loss, arising out of, in connection with, or relating to the use of the information contained in or referenced by this manual, even if ZKTeco has been advised of the possibility of such damages.

This manual and the information contained therein may include technical, other inaccuracies or typographical errors. ZKTeco periodically changes the information herein which will be incorporated into new additions/amendments to the manual. ZKTeco reserves the right to add, delete, amend, or modify the information contained in the manual from time to time in the form of circulars, letters, notes, etc. for better operation and safety of the machine/unit/equipment. The said additions or amendments are meant for improvement /better operations of the machine/unit/equipment and such amendments shall not give any right to claim any compensation or damages under any circumstances.

ZKTeco shall in no way be responsible (i) in case the machine/unit/equipment malfunctions due to any non-compliance of the instructions contained in this manual (ii) in case of operation of the machine/unit/equipment beyond the rate limits (iii) in case of operation of the machine and equipment in conditions different from the prescribed conditions of the manual.

The product will be updated from time to time without prior notice. The latest operation procedures and relevant documents are available on <http://www.zkteco.com>

If there is any issue related to the product, please contact us.

ZKTeco Headquarters

Address ZKTeco Industrial Park, No. 32, Industrial Road,
Tangxia Town, Dongguan, China.

Phone +86 769 - 82109991

Fax +86 755 - 89602394

For business-related queries, please write to us at sales@zkteco.com.

To know more about our global branches, visit www.zkteco.com.

About the Company

ZKTeco is one of the world's largest manufacturer of RFID and Biometric (Fingerprint, Facial, Finger-vein) readers. Product offerings include Access Control readers and panels, Near & Far-range Facial Recognition Cameras, Elevator/floor access controllers, Turnstiles, License Plate Recognition (LPR) gate controllers and Consumer products including battery-operated fingerprint and face-reader Door Locks. Our security solutions are multi-lingual and localized in over 18 different languages. At the ZKTeco state-of-the-art 700,000 square foot ISO9001-certified manufacturing facility, we control manufacturing, product design, component assembly, and logistics/shipping, all under one roof.

The founders of ZKTeco have been determined for independent research and development of biometric verification procedures and the productization of biometric verification SDK, which was initially widely applied in PC security and identity authentication fields. With the continuous enhancement of the development and plenty of market applications, the team has gradually constructed an identity authentication ecosystem and smart security ecosystem, which are based on biometric verification techniques. With years of experience in the industrialization of biometric verifications, ZKTeco was officially established in 2007 and now has been one of the globally leading enterprises in the biometric verification industry owning various patents and being selected as the National High-tech Enterprise for 6 consecutive years. Its products are protected by intellectual property rights.

About the Manual

This manual introduces the operations of ZK-IWB Series.

All figures displayed are for illustration purposes only. Figures in this manual may not be exactly consistent with the actual products.

Document Conventions

Conventions used in this manual are listed below:

GUI Conventions

For Software	
Convention	Description
Bold font	Used to identify software interface names e.g., OK , Confirm , Cancel .
>	Multi-level menus are separated by these brackets. For example, File > Create > Folder.
For Device	
Convention	Description
<>	Button or key names for devices. For example, press <OK>.
[]	Window names, menu items, data table, and field names are inside square brackets. For example, pop up the [New User] window.
/	Multi-level menus are separated by forwarding slashes. For example, [File/Create/Folder].

Symbols





Convention	Description
	This represents a note that needs to pay more attention to.
	The general information which helps in performing the operations faster.
	The information which is significant.
	Care taken to avoid danger or mistakes.
	The statement or event that warns of something or that serves as a cautionary example.

Table of Contents

1 OVERVIEW	6
1.1 FEATURES	6
1.2 APPEARANCE	7
1.3 DIMENSION	8
2 TERMINAL BLOCK	9
2.1 HD OUT CONNECTION	10
2.2 HD IN CONNECTION	11
2.3 USB INPUT	11
2.4 NETWORK SIGNAL INPUT	12
2.5 AUDIO SIGNAL INPUT OR OUTPUT	12
2.6 RS232 DEVICE CONNECTION	12
2.7 EXTERNAL COMPUTER AND TOUCH CONNECTION	13
2.8 CONFIGURATION OF PLUGGABLE BUILT-IN COMPUTER OPS (OPTIONAL)	15
3 MENU OPERATIONS	16
3.1 MAIN INTERFACE	16
3.2 WIRELESS AND NETWORK SETTINGS	16
3.3 SHARE SETTINGS	17
3.4 DEVICE SETTINGS	17
3.5 PERSONAL SETTINGS	17
3.6 SYSTEM SETTINGS	18
4 PACKAGE	19
APPENDIX	20
SAFETY WARNING	20
FAQ	22
SIMPLE TROUBLESHOOTING	24
MAINTENANCE	25
ECO-FRIENDLY OPERATION	26

1 Overview

ZK-IWB Series intelligent conference tablet sets the core functions required in the three major conference scenarios of writing, display, and collaboration, not only breaking the traditional conference discussion form, but also promoting a new way of efficient and collaborative office. Behind the booming conference tablet market is the strong need of countless enterprises urgently wishing to realize digital and intelligent transformation and promote the digitalization of office space, as well as the opportunity brought by new changes in corporate office habits and communication methods in the post-epidemic era, in which ZK-IWB Series has gained the favor of the market with its strong quality assurance and insight of customer needs as the core.

1.1 Features

1. **Convenient for virtual meetings:** Built-in 8-megapixel HD camera and 6-array microphone with 8-meter pickup distance, providing clear audio and video experiences.
2. **Smart Whiteboard Software:** User-friendly, more efficient and creative.
3. **4K Ultra HD screen and infrared touch:** Improved image sharpness and simultaneous writing and commenting without getting messy.
4. **Collaborative Presentations:** Real-time screen sharing between devices with wireless software.
5. **Dual OS:** Built-in Android system and Windows (Optional); capable of installation of multiple software.

1.2 Appearance

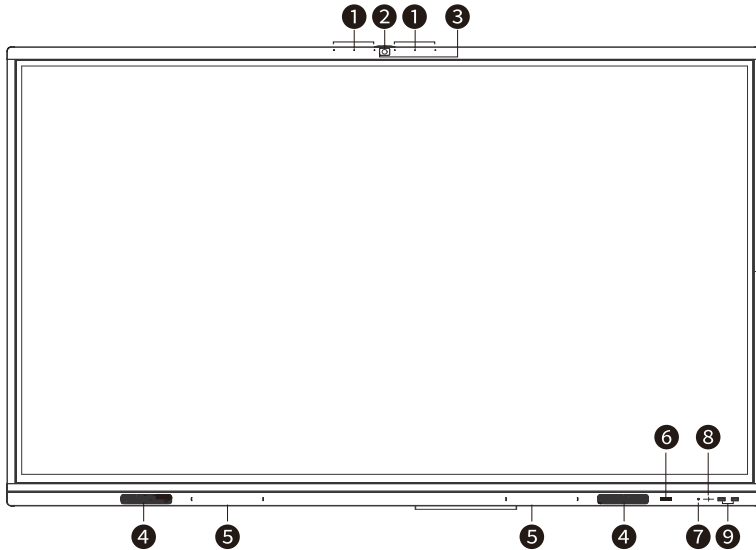

No.	Description
1	Microphones
2	Camera
3	Camera working status indicator
4	Speaker
5	Pen adsorption area
6	Power button, lightly press to enter energy-saving mode, long press for at least 2 seconds to enter standby mode
7	Light sensor
8	Remote control reception
9	USB

1.3 Dimension

The ZK-IWB Series is available in three different dimensions:

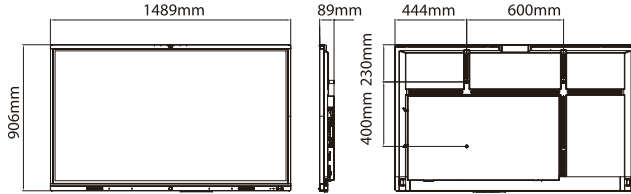

ZK-IWB65B (S)

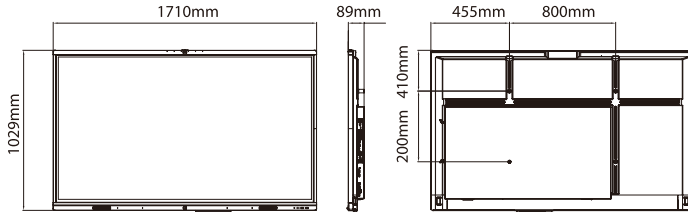

ZK-IWB75B (S)

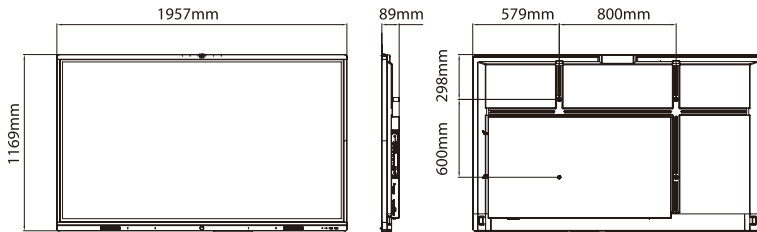

ZK-IWB86B (S)

2 Terminal Block

The terminal blocks are located on the side of the device, and the rich terminal interface gives the device powerful functions to meet different needs.

Note: The number and type of ports of the device are subject to the actual product, and the description in this manual is for example only.

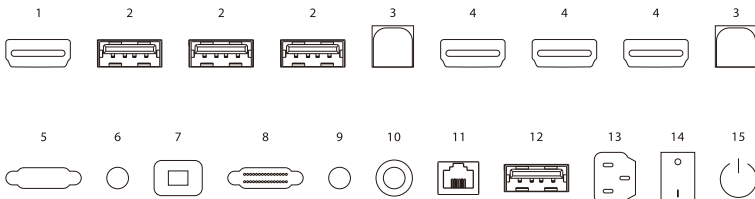

No.	Items	Description
1	HD OUT	HD signal can be output through HD cable.
2	USB3.0	Used to connect external storage devices, such as USB keyboards, U disks, and mobile hard disks.
3	TOUCH	Can be used for external devices to connect to the ZK-IWB series to enable touch.
4	HD IN	Simultaneous input of external device signals via HD cable to realize the local unit Dual display with external monitor.
5	VGA	Can be used to connect to a computer.
6	AUDIO IN	Connect to the audio input interface of the computer.
7	SPDIF	Can be used to connect audio device.
8	RS232	Used to connect external devices that can use the RS232 interface.
9	AUDIO OUT	Connect to the audio output interface of the computer.

10	WIFI ANTENNA	Enhance wireless network signal.
11	LAN	Used to connect LAN and WAN.
12	USB2.0	Used to connect external storage devices, such as USB keyboards, U disks, and mobile hard disks.
13	Power Outlets	AC power input, connected to AC power.
14	Boat Switch	The power switch is used to turn ON and OFF the AC power of the whole device. " I " means power- ON state, and " O " means power- OFF state.
15	OPS*	Turn ON or OFF the OPS computer. Note: Not all products have the function with OPS, the real product shall prevail.

2.1 HD OUT Connection

Connection Instructions:

1. Connect the display device with HD input with HD cable.
2. After connecting the cable, plug in the power cable and turn on the boat switch.
3. Lightly press the power button, the device is powered on.
4. HD signal output to the display device.

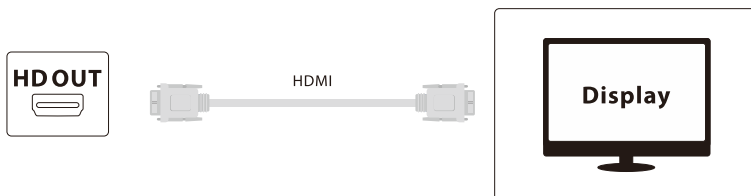

2.2 HD IN Connection

Connection Instructions:

1. HD signal output to the display device.
2. After connecting the cable, plug in the power cable and turn on the boat switch.
3. Lightly press the power button, the device is powered on.
4. Switch the input source to HD channel in the main interface.

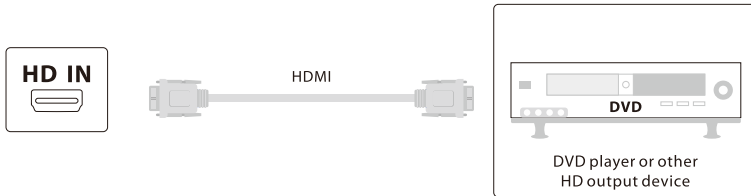

2.3 USB Input

With multiple USB 3.0 or USB 2.0, it can support the connection of multiple USB devices at the same time.

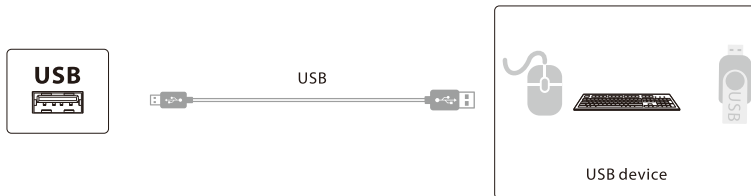

2.4 Network Signal Input

The device provides super category 6 network interface, 1000Mbps rate, stronger anti-interference ability, more stable transmission.

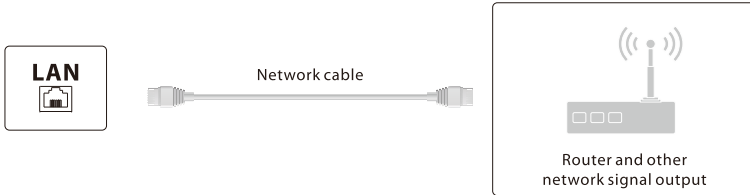

2.5 Audio Signal Input or Output

Audio interface for plugging in headphones, microphones and other audio devices.

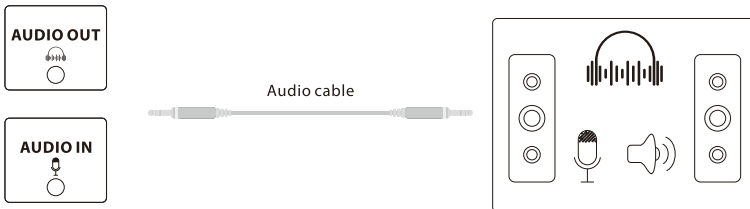

2.6 RS232 Device Connection

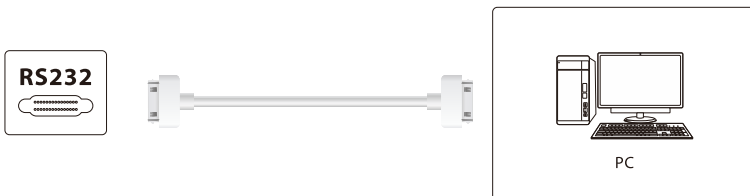

2.7 External Computer and Touch Connection

Connection Instructions:

1. Connect the USB port of the touch cable to the USB port of the external computer, and the TOUCH port of the touch cable to the TOUCH1 port of the device.
2. Use the HD cable to connect the HD1 or HD2 interface of the device, and then connect the HD interface of the external computer.
3. After connecting the cable, plug in the power cable and turn on the boat switch.
4. Start the external computer.
5. Lightly press the power button, the device is powered on.
6. Switch to the HD channel.

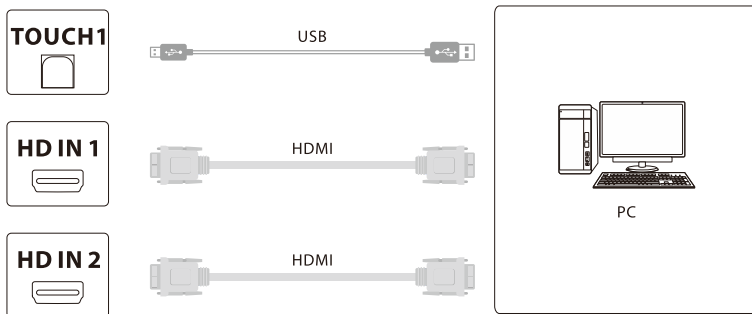

After you finish connecting one set of touch and computer combination, you can also connect another set of touch and computer combination.

Connection Instructions:

1. Connect the USB port of the touch cable to the USB port of the external computer, and the TOUCH port of the touch cable to the TOUCH2 port of the device.
2. Use the HD cable to connect the HD3 or VGA interface of the device, and then connect the HD or VGA interface of the external computer.
3. After connecting the cable, plug in the power cable and turn on the boat switch.
4. Start the external computer.
5. Lightly press the power button, the device is powered on.
6. If the connection is the HD interface will switch to the HD channel, connected to the VGA interface will switch the VGA channel

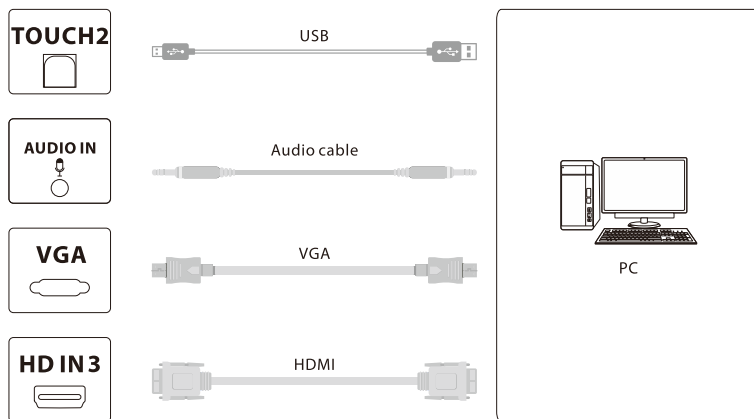

2.8 Configuration of Pluggable Built-in Computer OPS (Optional)

- **CPU:** Intel I3/I5/I7
- **Chipset:** Intel chipset
- **Memory:** 2G/4G DDR3; motherboard supports up to 16G DDR3
- **Hard disk:** 2.5-inch 120G/500G/1TB
- **Graphics Card:** integrated high-performance graphics card/independent graphics card
- **Display resolution:** 1920 * 1080 / 3840 * 2160
- **Operating system:** Windows7/Windows8/Windows10
- **Interface:** USB3.0 X2, USB2.0 X4, RJ45 X1, HD Output X1, VGA Output X1, Audio Output X1, Audio Input X1, RS232 X1

Note: Not all products have the function with OPS, the real product shall prevail.

3 Menu Operations

3.1 Main Interface

After the device is successfully connected, the following screen is displayed:



- Click the **Apps** icon with the Magnetic stylus, Settings, File Explorer, and other applications under this menu.
- The settings menu is divided into five sections: **Wireless & Network**, **Sharing**, **Devices**, **Personal**, and **System**.

3.2 Wireless and Network Settings

Click [**Wireless & network**] on the **Settings** interface, you can set up Wi-Fi, Ethernet, Wireless Hotspot and Bluetooth. Select the corresponding network method and turn on or off the network connection by clicking on the  icon.

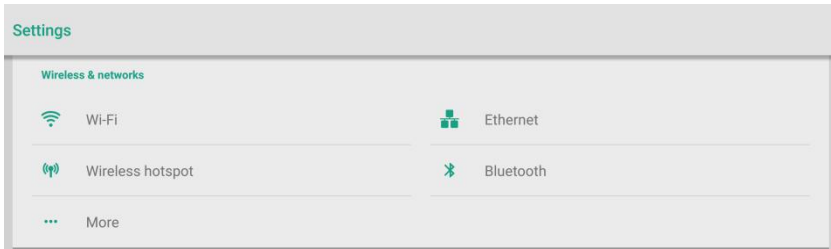

3.3 Share Settings

Click **[Share]** > **[SAMBA Service]** on the **Settings** interface. File resources can be shared using the SAMBA sharing service.

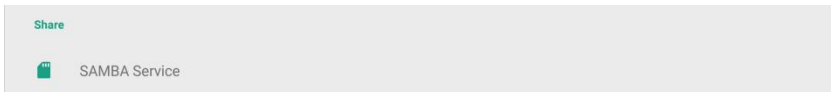

3.4 Device Settings

Click **[Device]** on the **Settings** interface. You can set the Display and Volume of the device, browse the Storage of the device and the installed applications, and uninstall the installed applications.

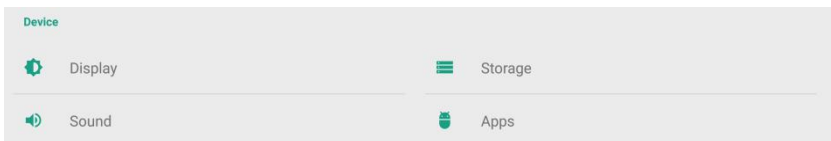

3.5 Personal Settings

Click **[Personal]** on the **Settings** interface. You can set the Security, Language & input, Startup & shutdown, Password, Input Setting and Other Settings of the device.

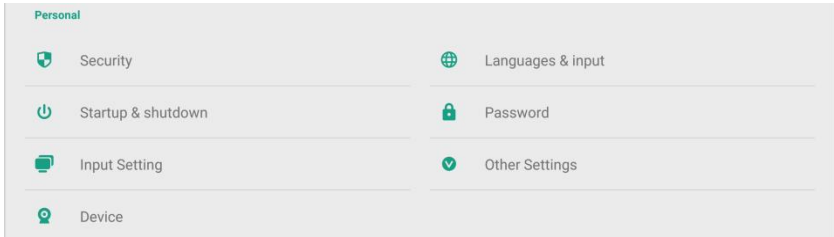



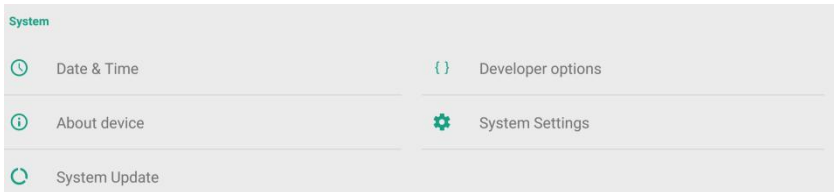

3.6 System Settings

Click [**System**] on the **Settings** interface. You can set the Date & Time, Developer options and System Update.



4 Package

The package consists of the following items:

Items	
	ZK-IWB X1
	Power Cable X1
	Magnetic Stylus X2
	User Manual X1

Appendix

Safety Warning

Placement

- Do not place heavy objects on the device.
- Do not insert any objects into the inside of the device.
- Do not place the device next to device that emits strong radiation.
- Do not place the device in a wet or liquid dripping area.
- Do not place the device in an area that is unstable, prone to tilting or falling.
- Do not place the device in the vicinity of direct sunlight or other strong light sources.

Power Supply

- Unplug the power cable in lightning and flashing weather.
- Do not expose the power cable to physical or mechanical damage.
- Check and ensure that the AC power cable ground is on.
- Please use the special power cable, do not modify and extend the power cable.
- Please unplug the power supply when the room is unoccupied or not in use for a long time.
- Please check and ensure the matching of the voltage value of the nameplate on the back case and the main supply voltage value.

Screen

- Contact the service center for cleaning the inside of the device.
- Unplugging the power supply when cleaning is required.
- Please wipe the screen with a flexible, dust-free and dry cloth.
- Do not clean the screen with water and aerosol cleaners.
- Do not leave a screen with high brightness on it for a long time.

- Do not use hard or sharp objects to write on the screen.

Temperature

- Normal working temperature of the device is 0° to 40°C.
- Do not place the device near heat-generating objects such as electric heaters or radiators or other heat sources.
- When the device is moved from the low temperature area to the high temperature area, in order to make the condensation inside the device fully emitted, please leave it for a period of time before powering on the device.

Humidity

- Do not expose the device to rain, humidity or near water.
- Please keep the room dry and cool, and the normal working humidity of the device is 10% to 90%RH.

Ventilation

- Please place the device in a ventilated place to ensure good heat dissipation from the device.
- Ensure that the whole device is ventilated to the left, right and 10 cm behind and 20 cm above the top.

Standby

The standby button on the body allows the device to be in standby mode and does not completely shut down the device.

Battery

- The waste batteries after the use of this device need to be properly disposed of and recycled.
- Please do not let children touch the battery and do not put the battery into the fire to avoid danger.

Cleaning requirements

This product has heat dissipation holes in the rear shell, please do not spray or pour liquid directly to the rear shell part when cleaning or use a wet cloth to clean.

Switch state description

The mechanical switch of the product " I " indicates the energized state, " O " indicates the power-off state.

Maintenance precautions

- Please seek professional service personnel for all repairs.
- If the equipment is damaged, such as the power cord or plug is damaged, liquid is spilled or objects are dropped inside the equipment, the equipment is wet or damp or does not work properly, or falls to the ground, please call the service hotline for repair, do not dismantle the device for maintenance by yourself.

FAQ

1. Why does fogging often appear on the screen?

In order to ensure the safety of the screen, this product adds a layer of tempered glass on the outside of the screen, and to ensure heat dissipation, there should be a certain gap between the two, which is used to reserve air channels for air convection. The main reason for the fog is the temperature difference between the screen and the outside temperature, the hot air meets the lower temperature of the glass surface condensation, resulting in water mist. Water fog does not affect the normal use, generally after a few hours of use on the fog will slowly evaporate and disappear.

2. Why are the device start-up times different in different conference rooms?

In general, the phenomenon of slow boot-up will occur when the external U disk, Internet access makes the device poisoned, or the hard disk space is occupied, or the system disk is damaged. You can call our service hotline, professional engineers will judge and guide to solve the problem for you remotely.

3. No sound from external laptop devices?

If the VGA line connection, only the image transmission, you need to connect the audio line again; the same only connect the audio line is unable to out sound, you need to connect the VGA line to identify to the VGA channel or you can choose the HD line connection.

4. Is it normal to feel the screen overheating after a period of use? Is there a bad effect?

The heat of the screen body is normal, just like the TV at home, there will be no adverse effects. At present, the heat dissipation design of our whole device is leading in the industry, and is the industry standard setter, which is in line with international health standards.

5. Will long-term use damage the eyes?

The human eye recognition of flicker is 50Hz. 50Hz below the human eye will be able to detect, eye muscles constantly adjust to adapt to flicker caused by eye fatigue, this product uses 60Hz and 120Hz LCD, so the human eye is actually not feeling the flicker of the screen, compared to other products of the same kind to a large extent to reduce eye fatigue.

Simple Troubleshooting

Automatic shutdown

- Whether the sleep function is turned on, refer to the general computer check items to troubleshoot.
- Check the channel where the input source is located, no signal will lead to automatic shutdown.
- Check the power supply stability.

Indicator light does not light up

- Check if the power supply is normal;
- Check whether the boat switch of the conference tablet is open.

Image missing color, color abnormalities

If using an external computer, check if the VGA/HD cable is not connected properly or damaged.

Display screen is not full or out of range

- Check that the resolution is the optimal 16:9 resolution.
- If using an external computer, plug in the VGA/HD cable.

The device has a picture without sound

- Please try to adjust the volume.
- If the conference level uses an external computer, check if the audio cable is connected correctly.

Touch positioning inaccuracy

- Check whether the touch pen or fingers are touching the screen vertically at 90 degrees.
- Check if other objects touch the screen, such as small strips of paper, sleeves.

Touch function is invalid

If the conference tablet uses an external computer, check whether the external contact touch cable is properly connected.

Maintenance

Simple Maintenance

1. Correct maintenance and care can avoid some simple failures.
2. Regular and careful cleaning can keep the device in good appearance and running condition.
3. Please unplug the power supply before cleaning and maintenance to prevent electric shock.

Cleaning the Screen

1. Mix a small amount of fabric softener or detergent with warm water and stir well.
2. Please use a soft cloth to completely soak in this mixture.
3. Please wring out a soft cloth and wipe the whole screen.
4. Repeated wiping (be careful not to get any water droplets inside the device while wiping) will complete the cleaning procedure.

Clean face frame

Please use a dry, soft, lint-free fabric or towel to wipe.

Leaving the device for a long time or not using it

When leaving the device for a long time or not using it, please be sure to unplug it and disconnect the power supply to prevent damage to the device due to external power fluctuations such as lightning.

Eco-friendly Operation



The product's "eco-friendly operational period" refers to the time during which this product will not discharge any toxic or hazardous substances when used in accordance with the prerequisites in this manual.

The eco-friendly operational period specified for this product does not include batteries or other components that are easily worn down and must be periodically replaced. The battery's eco-friendly operational period is 5 years.

Hazardous or Toxic substances and their quantities

Component Name	Hazardous/Toxic Substance/Element					
	Lead (Pb)	Mercury (Hg)	Cadmium (Cd)	Hexavalent Chromium (Cr6+)	Polybrominated Biphenyls (PBB)	Polybrominated Diphenyl Ethers (PBDE)
Display	×	○	○	○	○	○
Housing	○	○	○	○	○	○
Circuit Board Components*	×	○	○	○	○	○
Power Cord and Connection Cable	×	○	○	○	○	○

Metal Parts	○	○	○	○	○	○
Packaging Materials*	○	○	○	○	○	○
Remote Control	×	○	○	○	○	○
Speaker	×	○	○	○	○	○
Annexes	○	○	○	○	○	○
<p>○ indicates that the total amount of toxic content in all the homogeneous materials is below the limit as specified in SJ/T 11363—2006.</p> <p>× indicates that the total amount of toxic content in all the homogeneous materials exceeds the limit as specified in SJ/T 11363—2006.</p> <p>Note: 80% of this product’s components are manufactured using non-toxic and eco-friendly materials. The components which contain toxins or harmful elements are included due to the current economic or technical limitations which prevent their replacement with non-toxic materials or elements.</p>						

ZKTeco Industrial Park, No. 32, Industrial Road,
Tangxia Town, Dongguan, China.

Phone: +86 769 - 82109991

Fax : +86 755 - 89602394

www.zkteco.com



Copyright © 2022 ZKTECO CO., LTD. All Rights reserved.