

Network Video Decoder

User's Manual



Foreword

General





This user's manual (hereinafter referred to as "the Manual") introduces the installations, functions and operations of network video decoder (hereinafter referred to be "the Device").

Models

1-channel 4K high definition (H.265) series, 4-channel 4K high definition (H.265, with 2 input ports) series, 4-channel 8K high definition (H.265) series and 9/12/15/18/21-channel 4K high definition (H.265, with 4 input ports) series

Safety Instructions

The following categorized signal words with defined meaning might appear in the Manual.

Signal Words	Meaning
 DANGER	Indicates a high potential hazard which, if not avoided, will result in death or serious injury.
 WARNING	Indicates a medium or low potential hazard which, if not avoided, could result in slight or moderate injury.
 CAUTION	Indicates a potential risk which, if not avoided, could result in property damage, data loss, lower performance, or unpredictable result.
 TIPS	Provides methods to help you solve a problem or save you time.
 NOTE	Provides additional information as the emphasis and supplement to the text.

Revision History

Version	Revision Content	Release Time
V3.2.0	<ul style="list-style-type: none">● Add new series.● Update Important Safeguards and Warnings.	September 2021
V3.1.0	<ul style="list-style-type: none">● Add new series.● Delete function about audio.	June 2021
V3.0.0	Baseline revision.	November 2019
V2.0.0	Baseline revision.	March 2019
V1.0.0	First release.	June 2018

Privacy Protection Notice

As the device user or data controller, you might collect the personal data of others such as their face, fingerprints, and license plate number. You need to be in compliance with your local privacy protection laws and regulations to protect the legitimate rights and interests of other people by implementing measures which include but are not limited: Providing clear and visible identification to inform people of the existence of the surveillance area and provide required contact information.

About the Manual

- The manual is for reference only. Slight differences might be found between the manual and the product.
- We are not liable for losses incurred due to operating the product in ways that are not in compliance with the manual.
- The manual will be updated according to the latest laws and regulations of related jurisdictions. For detailed information, see the paper user's manual, use our CD-ROM, scan the QR code or visit our official website. The manual is for reference only. Slight differences might be found between the electronic version and the paper version.
- All designs and software are subject to change without prior written notice. Product updates might result in some differences appearing between the actual product and the manual. Please contact customer service for the latest program and supplementary documentation.
- There might be errors in the print or deviations in the description of the functions, operations and technical data. If there is any doubt or dispute, we reserve the right of final explanation.
- Upgrade the reader software or try other mainstream reader software if the manual (in PDF format) cannot be opened.
- All trademarks, registered trademarks and company names in the manual are properties of their respective owners.
- Please visit our website, contact the supplier or customer service if any problems occur while using the device.
- If there is any uncertainty or controversy, we reserve the right of final explanation.

Important Safeguards and Warnings

This section introduces content covering the proper handling of the Device, hazard prevention, and prevention of property damage. Read carefully before using the Device, comply with the guidelines when using it, and keep the manual safe for future reference.

Operation Requirements

WARNING

This is a class A product. In a domestic environment this may cause radio interference in which case the user may be required to take adequate measures.



- Make sure that the power supply of the device works properly before use.
- Do not pull out the power cable of the device while it is powered on.
- Only use the device within the rated power range.
- Transport, use and store the device under allowed humidity and temperature conditions.
- Prevent liquids from splashing or dripping on the device. Make sure that there are no objects filled with liquid on top of the device to avoid liquids flowing into it.
- Do not disassemble the device.
- Operating temperature: $-10\text{ }^{\circ}\text{C}$ to $+55\text{ }^{\circ}\text{C}$ ($14\text{ }^{\circ}\text{F}$ – $131\text{ }^{\circ}\text{F}$).

Installation Requirements

WARNING

- Connect the device to the adapter before power on.
- Strictly abide by local electrical safety standards, and make sure that the voltage in the area is steady and conforms to the power requirements of the device.
- Do not connect the device to more than one power supply. Otherwise, the device might become damaged.
- To prevent explosion, replace the battery with the correct model and dispose of the unwanted one as instructed.
- Do not expose the battery to environments where it can easily overheat such as with direct sunlight and fire.



- Observe all safety procedures and wear required protective equipment provided for your use while working at heights.
- Do not expose the device to direct sunlight or heat sources.
- Do not install the device in humid, dusty or smoky places.
- To ensure heat dissipation, the gap between the device and the surrounding area should not be less than 10 cm on the sides and 5 cm on top of the device.
- Use the power adapter or case power supply provided by the device manufacturer.

- The power supply must conform to the requirements of ES1 in IEC 62368-1 standard and be no higher than PS2. Note that the power supply requirements are subject to the device label.
- Connect class I electrical appliances to a power socket with protective earthing.
- When installing the device, make sure the power plug and appliance coupler are easy to reach to cut off the power.

Table of Contents

Foreword	I
Important Safeguards and Warnings	I
1 Product Overview	1
1.1 Introduction.....	1
1.2 Main Features.....	1
2 Check and Cable Connection	3
2.1 Unpacking the Box.....	3
2.2 Device Installation Diagram and Operation.....	3
2.2.1 Front Panel.....	3
2.2.2 Rear Panel.....	6
2.2.3 Installation and Connection.....	12
3 Local Interface Configuration	13
3.1 Start/Shutdown.....	13
3.1.1 Start.....	13
3.1.2 Shutdown.....	13
3.2 Software Interface Operation.....	13
3.2.1 Entering System Menu.....	13
3.2.2 Main Interface.....	14
3.2.3 Menu Introduction.....	15
3.3 Advanced Operation of Menu.....	16
3.3.1 Main Menu.....	16
3.3.2 Menu Navigation.....	17
3.3.3 General Settings.....	18
3.3.4 Network.....	19
3.3.5 BPS.....	20
3.3.6 Remote Device.....	21
3.3.7 System Info.....	23
3.3.8 Shutdown.....	25
4 Web Operations	27
4.1 Network Connection.....	27
4.2 System Login.....	27
4.3 Screen.....	29
4.3.1 Adding Video Wall.....	30
4.3.2 Window Configuration.....	30
4.3.3 Signal Configuration.....	32
4.3.4 Video Wall Management.....	34
4.4 Preview.....	48
4.4.1 Window Function.....	49
4.4.2 Signal Configuration.....	50
4.4.3 PTZ Control Panel.....	50
4.5 Setup.....	52
4.5.1 System Config.....	52
4.5.2 Network.....	65
4.5.3 Event Management.....	69

4.5.4 Signal Management.....	72
4.5.5 Display Management	79
4.6 Info.....	92
4.6.1 Card Info.....	92
4.6.2 Decode Info.....	92
4.6.3 Device Info.....	93
4.6.4 System Status	96
4.6.5 System Log.....	97
4.6.6 Online User.....	97
4.6.7 About.....	97
5 Alarm Input /Output Device	98
5.1 Alarm Port.....	98
5.2 Alarm Input Port.....	98
5.3 Alarm Output Port	99
5.4 Relay Parameters of Alarm Output Port	100
Appendix 1 Cybersecurity Recommendations	101

1 Product Overview

1.1 Introduction

DH series decoders are network video decoding devices designed and developed for online video surveillance system. The device has powerful data processing capability and stable network function, and supports diversified encoding formats. It is easy to extend, easy to maintain, and convenient to access. This design facilitates installation, deployment, unified control and system management of the entire online video surveillance system. Meanwhile, it substantially reduces overall system cost.

1.2 Main Features

Decoding

- Decoding capability of the decoder depends on its internal decoding chip.
- Real-time stream decoding
Obtain local real-time bit streams, encode and then output.
- Previous stream decoding
Obtain the local history bit streams, encode and then output.
- Information feedback
Web interface can accurately get current decoding status.

Network

- Support remote control with network.
- Synchronize system time with NTP server.
- After you configure the front-end encoding device information, decoder can automatically connect the encoding device, and then begin work independently and reliably.
- In forwarding mode, decoder can get the random data stream from the network server accurately, to realize decoding output.

Output Port

- 1-channel 4K high definition (H.265) series has 1 group output ports, including 1 VGA port and 1 HDMI port.
- 4-channel 8K high definition (H.265) series has 4 HDMI output ports.
- 6-channel 4K high definition (H.265, with 4 input ports) series respectively has 6 HDMI output ports.
- 9-channel 4K high definition (H.265, with 4 input ports) series respectively has 9 HDMI output ports.
- 12-channel 4K high definition (H.265, with 4 input ports) series respectively has 12 HDMI output ports.

- 15-channel 4K high definition (H.265, with 4 input ports) series respectively has 15 HDMI output ports.
- 18-channel 4K high definition (H.265, with 4 input ports) series respectively has 18 HDMI output ports.
- 21-channel 4K high definition (H.265, with 4 input ports) series respectively has 21 HDMI output ports.



These products can realize real-time surveillance by monitor, and support alarm tour output and decoding tour.

Input Port

6/9/12/15/18/21-channel 4K high definition (H.265, with 4 input ports) series have 2 HDMI input ports and 2 DVI-I input ports respectively.

Alarm

- External Alarm
Multiple-channel relay alarm output to activate the peripheral alarm device (such as on-site light control), manual control and activation video output.
- Decoder Alarm
Remind users about present decoding status.

Serial Port

- Support peripheral device control function. The control protocol and connection port can be set freely according to your customized requirements.
- Support transparent data transmission of various ports, such as RS-232.

User Management

Users with the same authorities can belong to one group. Each group has one authority set, as one subset of overall authority set; authority set of each group can be edited. The user authority cannot exceed the group authority.

AUX Function

- Support user to view version information, display device important hardware port information, software version information and etc.
- Log search function.
- Time Synchronization: System time can be set manually, or synchronized with PC time directly.
- Provide automatic maintenance of the device at fixed time.
- Support update through network and web.

2 Check and Cable Connection



- For installation requirement of the decoder, refer to engineering construction specifications and national standards.
- HDMI cable quality and length affect the video quality. The video might blur, have noise or black edge. Sometimes the video quality might vary when the same video is output with different cables.

2.1 Unpacking the Box

When you receive the decoder, please check whether there is any visible damage or not. The protective materials used for the package of the device can resist most accidental collisions during transportation.

The label at the bottom of the box is very important, because there is serial number and other information. Usually we need you to present the serial number when we provide after-sales service. Do not tear or discard it.

2.2 Device Installation Diagram and Operation



2.2.1 Front Panel







2.2.1.1 1-channel 4K High Definition (H.265) Series and 4-channel 8K High Definition (H.265) Series

Figure 2-1 Front panel



Table 2-1 Description for front panel

Name	Icon	Function
Power button		Power button. <ul style="list-style-type: none">• Press it for 3 times within 1 second to restore default password.• Press it for 5 times within 1 second to restore factory default settings.
Power indicator		The indicator glows after system boots up.





Name	Icon	Function
Network indicator		The network indicator glows blue when abnormal network event occurs (offline, IP conflict and etc.).
USB port		Connect external devices such as mouse, keyboard and flash drive.
Alarm indicator		The alarm indicator is on when there is an alarm.
HDD indicator		Reserved function.
IR receiver		Reserved function.
Output indicator		Indicate working status of output port. Only the first indicator is effective.



2.2.1.2 6/9-channel 4K High Definition (H.265, with 4 Input Ports) Series

Figure 2-2 Front panel



Table 2-2 Front panel introduction

Name	Icon	Function
Power button		<p>Power button.</p> <ul style="list-style-type: none"> Press it for 3 times within 1 second to restore default password. Press it for 5 times within 1 second to restore factory default settings.
Power indicator		The indicator is on after system boots up.
Network indicator		<ul style="list-style-type: none"> The network indicator glows blue when abnormal network event occurs (offline, IP conflict and etc.). In case of dual Ethernet cards, in multi-address mode, insert one network cable, and the blue indicator is on.
USB port		Connect external devices such as mouse, keyboard and flash drive.

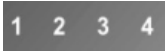
Name	Icon	Function
Alarm indicator		The alarm indicator is on when there is an alarm.
HDD indicator		Reserved function.
IR receiver		Reserved function.
Output indicator		Indicate working status of output port. For 9-channel 4K high definition (H.265) and 9-channel 4K high definition (H.265, with 4 input ports), indicators 1–9 are effective.

2.2.1.3 12/15/18/21-channel 4K High Definition (H.265, with 4 Input Ports)

Series

Figure 2-3 Front panel

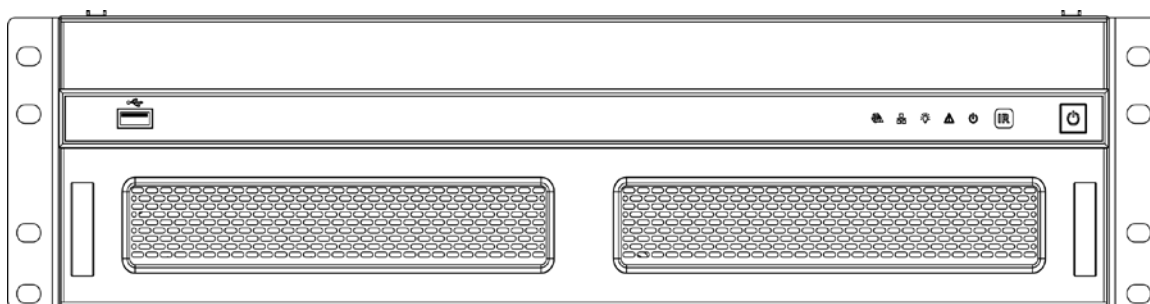









Table 2-3 Front panel introduction

Name	Icon	Function
Power button		Press it for three seconds to boot up or shut down the device.
IR receiver		Reserved function.
Power indicator		The indicator is on after system boots up.
Alarm indicator		The alarm indicator is on when there is an alarm.
Operation indicator		Operation indicator is on when the device is operating.
Network indicator		Reserved function.

Name	Icon	Function
Fan indicator		Reserved function.
USB port		Connect external USB device.

2.2.2 Rear Panel

2.2.2.1 1-channel 4K High Definition (H.265) Series

Figure 2-4 Rear panel

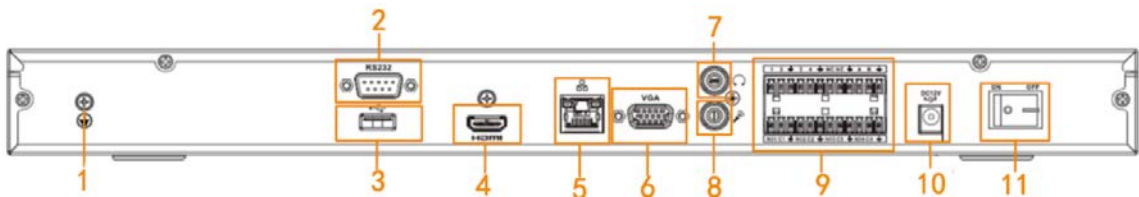

Table 2-4 Description for rear panel

No.	Name	No.	Name	No.	Name
1	Ground screw hole	2	RS-232 port	3	USB port
4	HDMI port	5	Network port (10 M/100 M/1000 M Ethernet port)	6	VGA port
7	Earphone port (Reserved)	8	Microphone port (Reserved)	9	4-channel alarm input, 4-channel alarm output, RS-485 port
10	Power port	11	Power button	-	-

2.2.2.2 4-channel 8K High Definition (H.265) Series

Figure 2-5 Rear panel

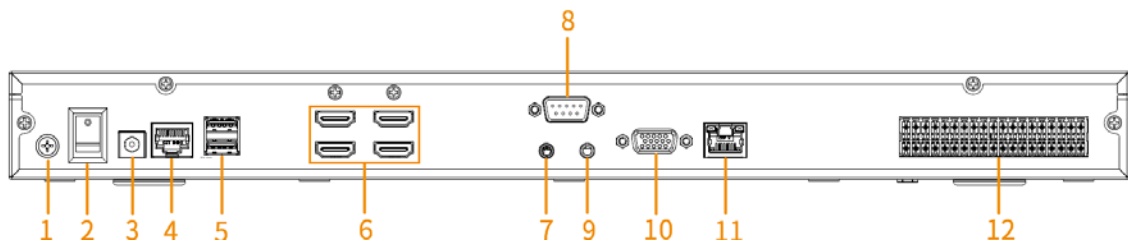

Figure 2-1 Rear panel

No.	Name	No.	Name	No.	Name
1	Ground screw hole	2	Power button	3	Power port
4	RS-232 port of screen control	5	USB port	6	HDMI output port

No.	Name	No.	Name	No.	Name
7	Earphone port (Reserved)	8	RS-232 port	9	Microphone port (Reserved)
10	VGA (Reserved)	11	Network port (10 M/100 M/1000 M Ethernet port)	12	Alarm input, alarm output, standard RS-485 port

2.2.2.3 6-channel 4K High Definition Series

Figure 2-2 Rear panel

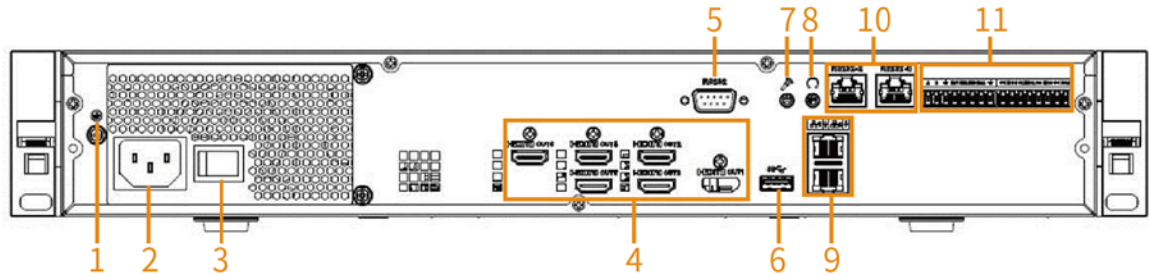

Table 2-5 Description for rear panel

No.	Name	No.	Name	No.	Name
1	Ground screw hole	2	Power port	3	Power button
4	HDMI output port	5	RS-232 port	6	USB 3.0 port
7	Microphone port (Reserved)	8	Earphone port (Reserved)	9	Network port (10 M/100 M/1000 M Ethernet port)
10	RS-232 port of screen control	11	Alarm input, alarm output, standard RS-485 port	-	-

2.2.2.4 6-channel 4K High Definition H.265 Series with 4 Input Ports

Figure 2-3 Rear panel

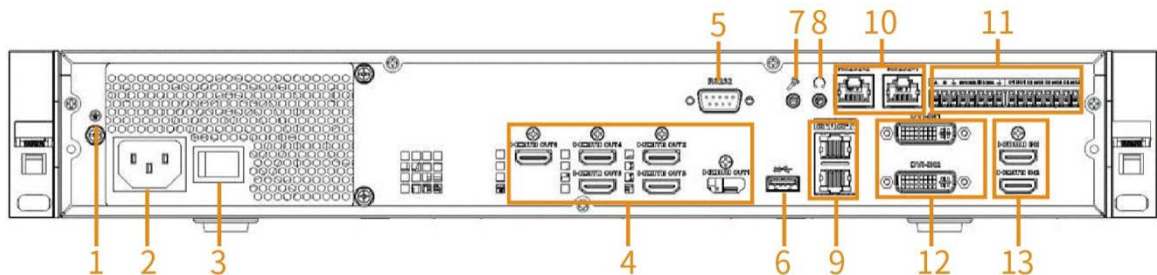

Table 2-6 Description for rear panel

No.	Name	No.	Name	No.	Name
1	Ground screw hole	2	Power port	3	Power button
4	HDMI output port	5	RS-232 port	6	USB 3.0 port

No.	Name	No.	Name	No.	Name
7	Microphone port (Reserved)	8	Earphone port (Reserved)	9	Network port (10 M/100 M/1000 M Ethernet port)
10	RS-232 port of screen control	11	Alarm input, alarm output, standard RS-485 port.	-	-

2.2.2.5 9-channel 4K High Definition Series

Figure 2-4 Rear panel

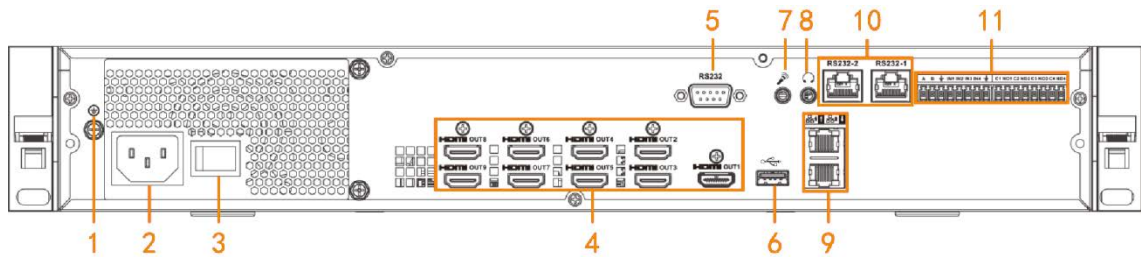

Table 2-7 Description for rear panel

No.	Name	No.	Name	No.	Name
1	Ground screw hole	2	Power port	3	Power button
4	HDMI output port	5	RS-232 port	6	USB 3.0 port
7	Microphone port (Reserved)	8	Earphone port (Reserved)	9	Network port (10 M/100 M/1000 M Ethernet port)
10	RS-232 port of screen control	11	Alarm input, alarm output, standard RS-485 port.	-	-

2.2.2.6 9-channel 4K High Definition H.265 Series with 4 Input Ports

Figure 2-5 Rear panel

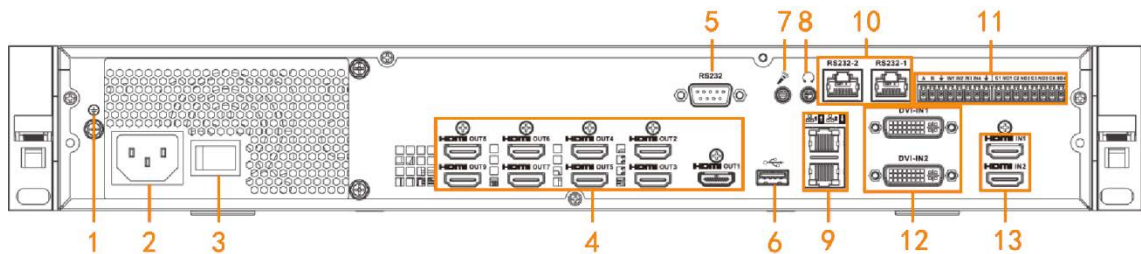

Table 2-8 Rear panel introduction

No.	Name	No.	Name	No.	Name
1	Ground screw hole	2	Power port	3	Power button
4	HDMI output port	5	RS-232 port	6	USB 3.0 port

No.	Name	No.	Name	No.	Name
7	Microphone port (Reserved)	8	Earphone port (Reserved)	9	Network port (10 M/100 M/1000 M Ethernet port)
10	RS-232 port of screen control	11	Alarm input, alarm output, standard RS-485 port.	12	DVI-I input port
13	HDMI input port	-	-	-	-

2.2.2.7 12/15/18/21-channel 4K High Definition (H.265, with 4 Input Ports) Series

Series

Figure 2-6 Rear panel of 21-channel 4K high definition (H.265, with 4 input ports) series

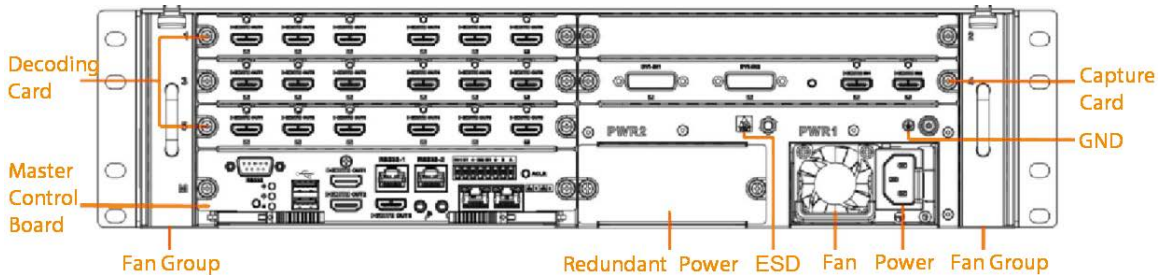

Figure 2-7 Rear panel of 18-channel 4K high definition (H.265, with 4 input ports) series

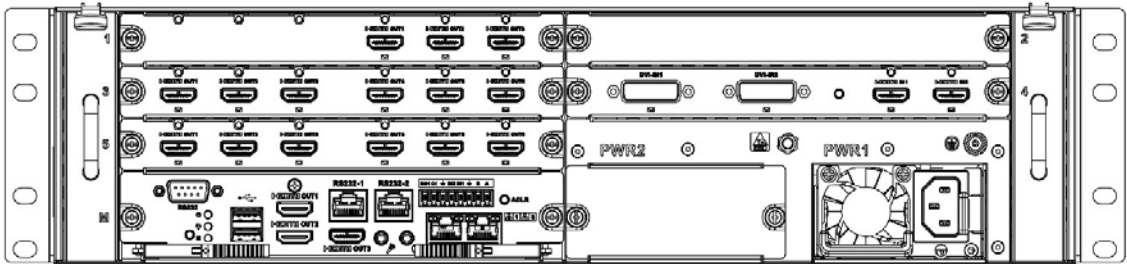

Figure 2-8 Rear panel of 15-channel 4K high definition (H.265, with 4 input ports) series

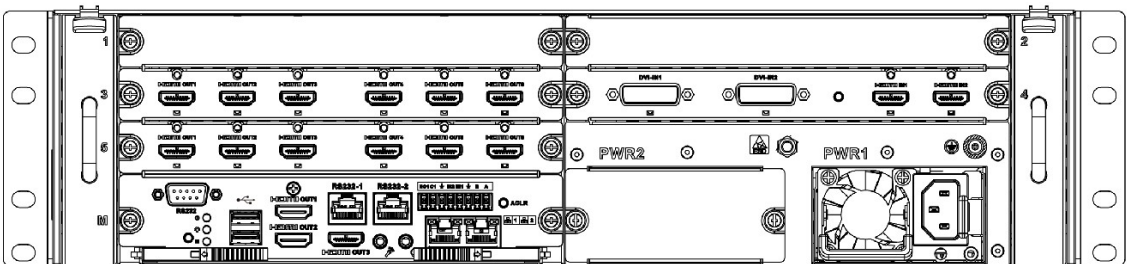
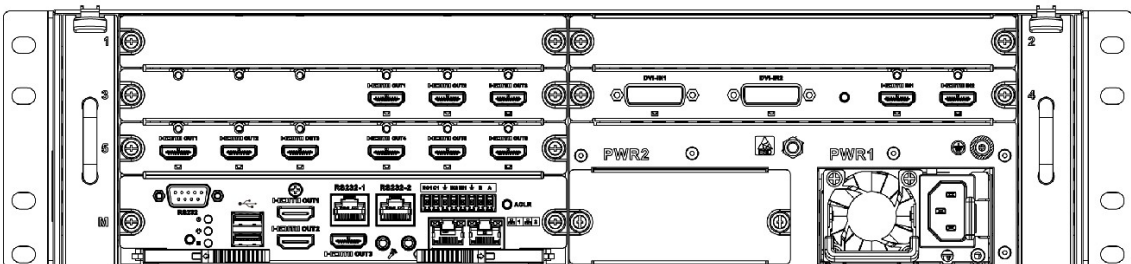

Figure 2-9 Rear panel of 12-channel 4K high definition (H.265, with 4 input ports) series





- For the above four series, they only have different decoding card types. The rest parts are the same.
- For 12/15/18/21-channel 4K high definition series and 12/15/18/21-channel 4K high definition (with 4 input ports) series, the only difference is one series has the capture card and the other does not have capture card. The rest parts are the same.

2.2.2.8 Master Control Board

Figure 2-10 Master control board

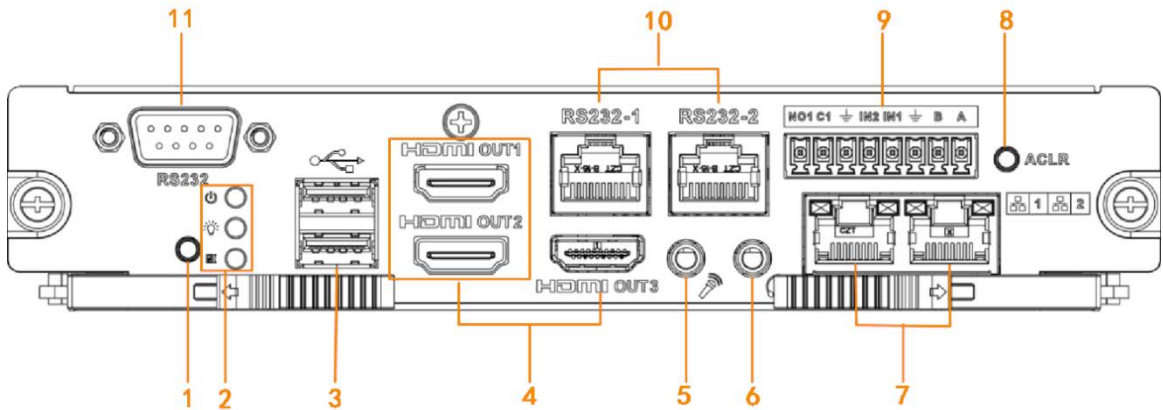

Table 2-9 Master control board introduction

No.	Name	No.	Name	No.	Name
1	Default button	2	<ul style="list-style-type: none"> • Power indicator of master control board • System status indicator • PCI-E status indicator 	3	USB port
4	HDMI output port	5	Microphone port (Reserved)	6	Earphone port (Reserved)
7	Network port	8	Alarm clear button	9	2-channel alarm input, 1-channel alarm output, RS-485 port
10	RS-232 port of screen control	11	RS-232 serial port	-	-

2.2.2.9 Decoding Card

Figure 2-11 3-channel decoding card

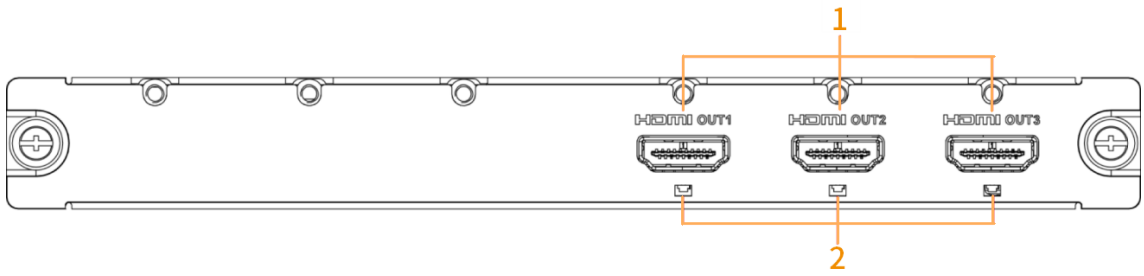

Figure 2-12 6-channel decoding card

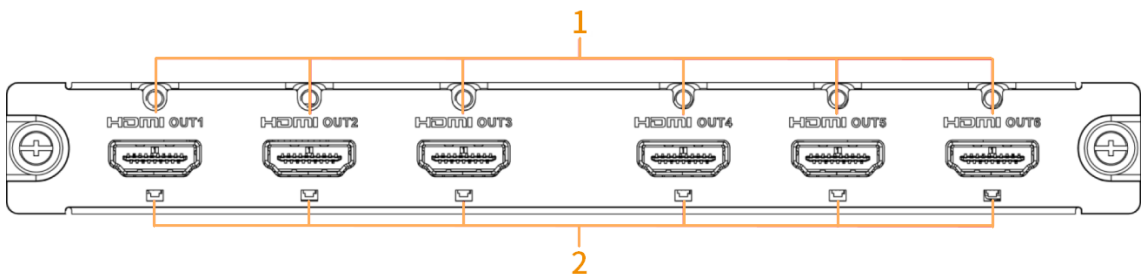

Table 2-10 Decoding card introduction

No.	Name	No.	Name
1	HDMI output port	2	Indicator

2.2.2.10 Capture Card

Figure 2-13 Capture card

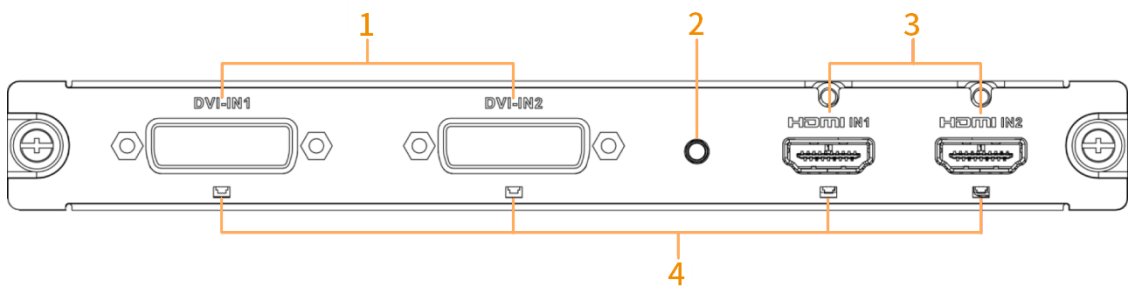

Table 2-11 Capture card introduction

No.	Name	No.	Name	No.	Name
1	DVI input port	2	Start button of backup area	3	HDMI input port
4	Indicator	-	-	-	-

2.2.3 Installation and Connection

2.2.3.1 Video Input Connection

All video data are encoded from the front-end device, and then input to the network with RJ45 port.

2.2.3.2 Selection and Connection of Video Output Device

- 1-channel 4K high definition (H.265) series has only 1 group of output ports, including 1 VGA port and 1 HDMI port.
- 4-channel 8K high definition (H.265) series has 4 HDMI output ports.
- 6-channel 4K high definition (H.265, with 4 input ports) series has 6 groups of output ports respectively. Each series has 6 HDMI ports.
- 9-channel 4K high definition (H.265, with 4 input ports) series has 9 groups of output ports respectively. Each series has 9 HDMI ports.
- 12-channel 4K high definition (H.265, with 4 input ports) series has 12 groups of output ports respectively. Each series has 12 HDMI ports.
- 15-channel 4K high definition (H.265, with 4 input ports) series has 15 groups of output ports respectively. Each series has 15 HDMI ports.
- 18-channel 4K high definition (H.265, with 4 input ports) series has 18 groups of output ports respectively. Each series has 18 HDMI ports.
- 21-channel 4K high definition (H.265, with 4 input ports) series has 21 groups of output ports respectively. Each series has 21 HDMI ports.

We recommend the industrial monitor to be output device of the decoder. It has the following advantages:

- The industrial monitor is suitable for long-time surveillance. Ordinary civil monitor easily gets aging, damaged or even burnt down after working for a long time.
- The industrial monitor boasts higher definition and color rendition than civil device.
- With strong anti-interference capability, it adapts to complicated application environment, and its stability is far better than ordinary device.

It is unreliable to use TV as video output device. You need to reduce the working hours and control the interference from power supply and other devices. The electric leakage risk resulting from low quality TV might damage other devices.

3 Local Interface Configuration



- Before operating on local interface, connect the display and other control devices (such as mouse and keyboard) to the decoder.
- This chapter takes 6/9/12/15/18/21-channel 4K high definition (h.265, with 4 input ports) series and 4-channel 8K high definition (H.265) series interfaces for example in most cases, which are just for your reference. 1-channel 4K high definition (h.265) series has slightly different interfaces. The actual product shall prevail.

3.1 Start/Shutdown

3.1.1 Start

Connect the device to the power and then press the power button on the rear panel. You can see the power indicator light turns on and device boots up.

3.1.2 Shutdown

You can press power button on the front panel for three seconds to shut down the device.



When decoder is working, if the power is cut off or the device is shut down forcibly, the system can automatically connect to the front-end device and restore previous working status, once the power connection becomes normal.

3.2 Software Interface Operation

3.2.1 Entering System Menu

- Step 1 Boot up the device.
The **Device Initialization** interface is displayed.

Figure 3-1 Device initialization

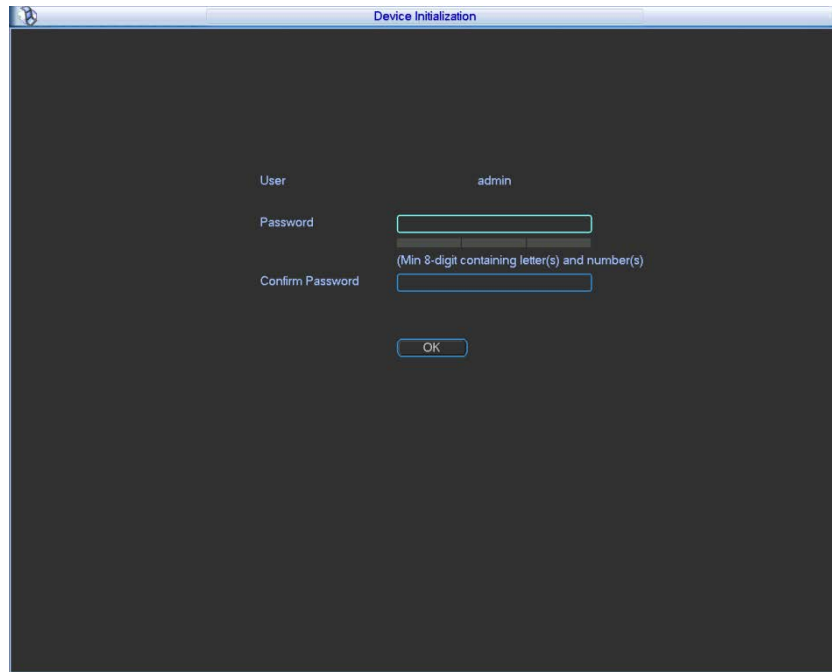

Step 2 Set admin user password.



The password can be set from 8 through 32 non-empty characters and contains at least two types from capital letter, lower-case letter, number, and special characters (excluding "", """, ";", ":" and "&"). **Password** and **Confirm Password** shall be the same. Enter a strong password according to the password strength indication.

Step 3 Click **OK**.

Step 4 Click right mouse button.

Figure 3-2 Login

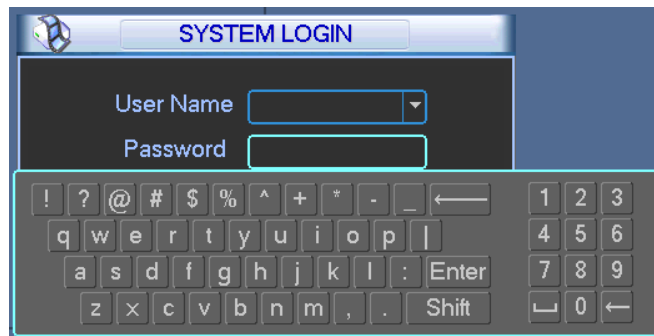

Step 5 Enter password, and then click **OK** to login.



The account will be locked if wrong password is entered for 5 times within every 30 minutes.

3.2.2 Main Interface

After login, the main interface is displayed.

Figure 3-3 Main interface

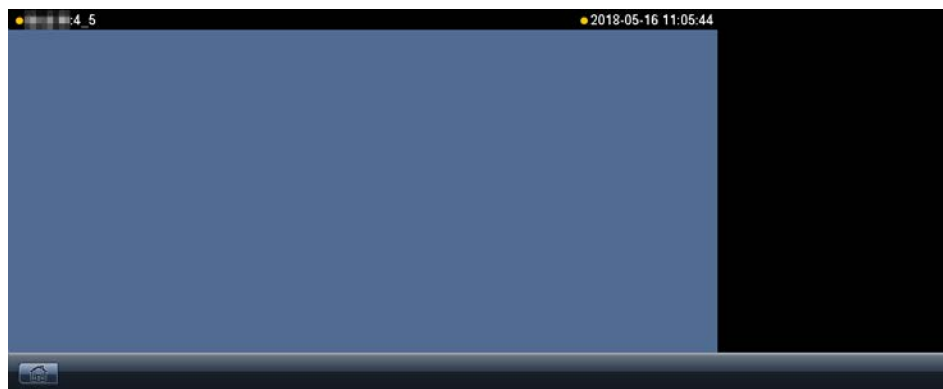

Figure 3-4 Main interface (1-channel 4K high definition series)



Table 3-1 Description of icons

No.	Name	Functional description
1	Display window	Display the splitting diagram of present output screen or fusion screen. Click one channel, and the corresponding area turns yellow. It means that the channel has been selected. Support to display 1, 4, 9, 16, 25, 36 and 64 screens at the same time.
2	Short-cut menu	Click to enter main menu interface.
3	Display control area	There are 7 display modes, including single, 4, 9, 16, 25, 36 and 64 channels. (High-definition decoding card is different from standard definition decoding card.)
4	Input device and output device	Display input/output device of each slot and channel. <ul style="list-style-type: none"> ● Output Device Click to switch to output device list. ● Input Device Click to switch to input device list.

3.2.3 Menu Introduction

Right-click the main interface, and the functional menu pops up.

Figure 3-5 Functional menu

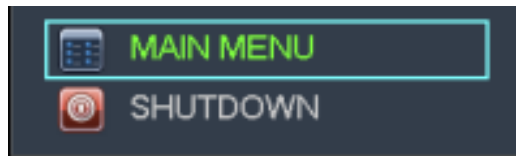

Table 3-2 Functional description

Name	Description
Main menu	Display main menu, including system setting, system info and shutdown.
Shutdown	Shut down the device.

3.3 Advanced Operation of Menu

3.3.1 Main Menu

6/9/12/15/18/21-channel 4K High Definition (H.265, with 4 Input Ports) Series and 4-channel 8K high definition (H.265) Series

Main menu includes system setting, system info and shutdown.



All the sub-menu settings will take effect after they are saved. Otherwise, the settings are invalid.

Figure 3-6 Main menu (1)

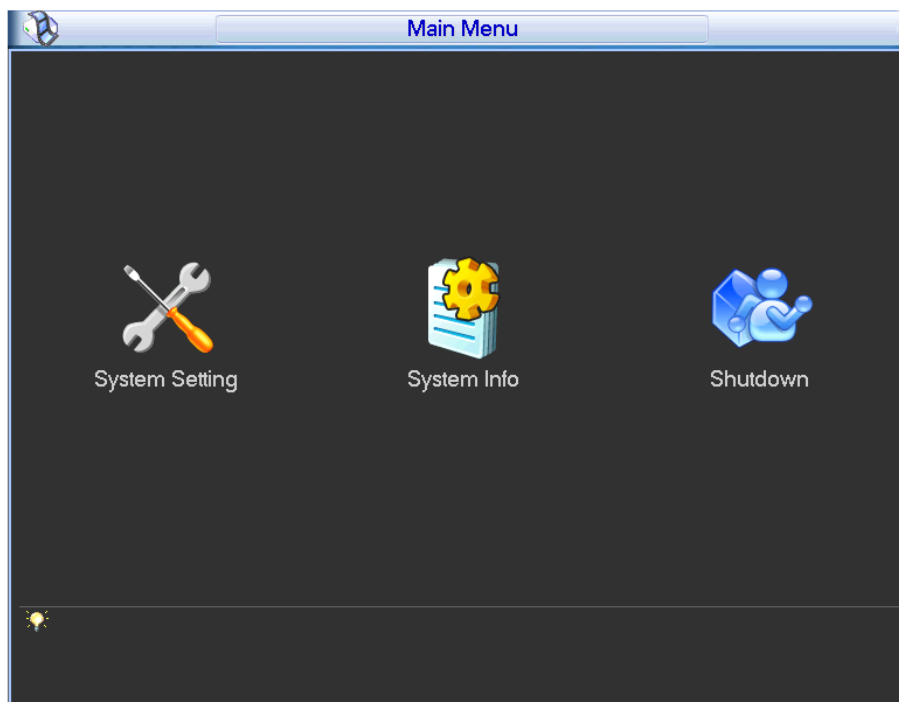

1-channel 4K High Definition (H.265) Series

Main menu includes general, network, BPS, remote device, version and shutdown.

Figure 3-7 Main menu (2)

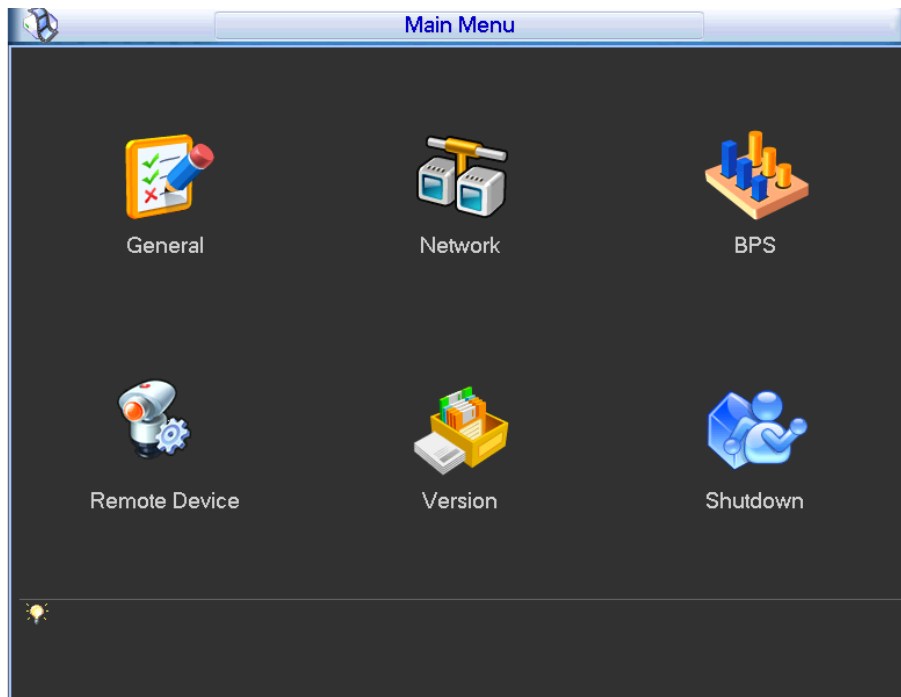

3.3.2 Menu Navigation

6/9/12/15/18/21-channel 4K High Definition (H.265, with 4 Input Ports) Series and 4-channel 8K high definition (H.265) Series

Table 3-3 Menu navigation (1)

Main menu	Sub menu	Description
System Setting	General	Set system time, device no. and other parameters.
	Network	Set IP address, video data transmission protocol and other parameters.
System Info	Version	View the version details such as system hardware feature, software version and build date.
	Online Users	View information about online users.
	Status	View fan speed, card and temperature information, source information, net percentage, CPU percentage and memory percentage.
Shutdown	-	Log out menu user, shut down system, restart system and switch user.

1-channel 4K High Definition (H.265) Series

Table 3-4 Menu navigation (2)

Main menu	Description
General	Set system time, device no. and other parameters.
Network	Set IP address, video data transmission protocol and other parameters.

Main menu	Description
BPS	Display real-time channel status, resolution and frame rate information.
Remote Device	Add and delete remote device.
Version	You can view the version details such as system hardware feature, software version and release date.
Shutdown	Log out menu user, shut down system, restart system and switch user.

3.3.3 General Settings

You can configure basic information of the device, such as device information, system time, and date format.



General settings shall be carried out by authorized users only.

Step 1 In the main menu, select **System Setting > General**.

The **General** interface is displayed.

Figure 3-8 General

Step 2 Configure parameters.



System time cannot be changed arbitrarily, or you cannot search records. System time can only be changed when it is not recording time according to hard drive information, or when the recording is stopped.

Table 3-5 General parameters description

Parameter	Description
System Time	Modify the current system date and time, and then click Save .

Parameter	Description
Date Format	Select date display format, including YYYY MM DD, MM DD YYYY and DD MM YYYY.
Date Separator	Separator of date format.
Time Format	Select 24-hour or 12-hour .
Language	Switch menu language, including Simplified Chinese and English.
Video Standard	Select video standard. It is PAL by default.
Device No.	Enter a number for the device.
Device Name	You can customize device name.
Auto Logout	Set menu standby time to be 0–60 minutes. There is no standby time when it is 0 minute. If the standby time is set, the system will log out current user after the idle period. You need to login again to operate the menu.

Step 3 Click **OK**.

3.3.4 Network

Configure device network parameters, so that device can communicate with devices in the network.

Step 1 In the main menu, select **System Setting > Network**.



For 1-channel 4K high definition (H.265) series, click **Network** on the **Main Menu** interface.

Figure 3-9 Network

The screenshot shows a 'Network' configuration window with the following fields and values:

- Net Mode: Fault Toleranc (dropdown), MAC ADDRESS (text)
- Network Device Name: Bond1 (dropdown)
- IP Version: IPv4 (dropdown)
- IP Address: 172.16.0.1 (text), DHCP:
- Subnet Mask: 255.255.0.0 (text)
- Gateway: 172.16.0.1 (text)
- TCP Port: 3777 (text), HTTP Port: 80 (text)
- UDP Port: 3778 (text)
- Max Connection: 128 (text)
- Preferred DNS: 0.0.0.0 (text)
- Alternate DNS: 0.0.0.0 (text)

Buttons at the bottom: Default, Save, Cancel.

Step 2 Configure parameters.

Table 3-6 Network parameters description

Parameter	Description
Net Mode	The default setting is multi-address for 1-channel 4K high definition (H.265) series, and fault tolerance for other models.
MAC Address	Configure MAC address.
Network Device Name	It is Bond1 by default.
Default Network Card	Only 1-channel 4K high definition (H.265) series can set the parameter.
IP Version	It is IPv4 by default.
IP Address	Enter numbers to change the IP address, and then configure its Subnet Mask and Gateway .
Subnet Mask	
Gateway	
DHCP	<p>Select the DHCP box, the system automatically obtains an IP address. When the DHCP function is enabled, the IP address, gateway, and subnet mask cannot be set manually.</p> <ul style="list-style-type: none"> ● If DHCP is effective, the obtained information will be displayed in the IP Address box, Subnet Mask box and Gateway box. If DHCP is not effective, they all display 0. ● To view manually set IP when DHCP is not effective, you shall disable DHCP first, and then the device will display IP info that is not obtained through DHCP. If DHCP is effective, and then DHCP is disabled, static IP information will restore default settings. You need to configure IP again. ● When PPPoE is enabled, IP address, subnet mask, gateway and DHCP cannot be changed.
Subnet Mask	Enter subnet mask and gateway corresponding to the IP address.
Gateway	 IP address and gateway must be in the same network segment.
TCP Port	It is 37777 by default. You can configure port.
HTTP Port	It is 80 by default. You can configure port.
UDP Port	It is 37778 by default. You can configure port.
Max Connection	Connection is 0 to 128. If it is 0, no network user connection is allowed. Max connection is 128.
Preferred DNS/Alternate DNS	Configure the address of DNS server.

Step 3 Click **Save**.

3.3.5 BPS



Only 1-channel 4K high definition (H.265) series support BPS.

Display real-time channel status, resolution and frame rate information.

In the main menu, select **BPS**. The **BPS** interface is displayed.

Figure 3-10 BPS

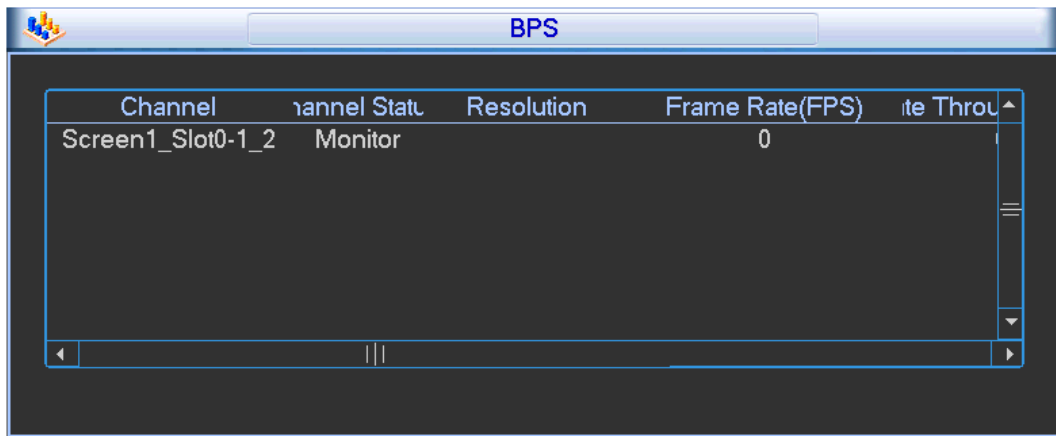

3.3.6 Remote Device



Only 1-channel 4K high definition (H.265) series support BPS.

Add remote device manually or automatically, edit, delete and upgrade the remote device.

In the main menu, select **Remote Device**. The **Remote Device** interface is displayed.

Figure 3-11 Remote device

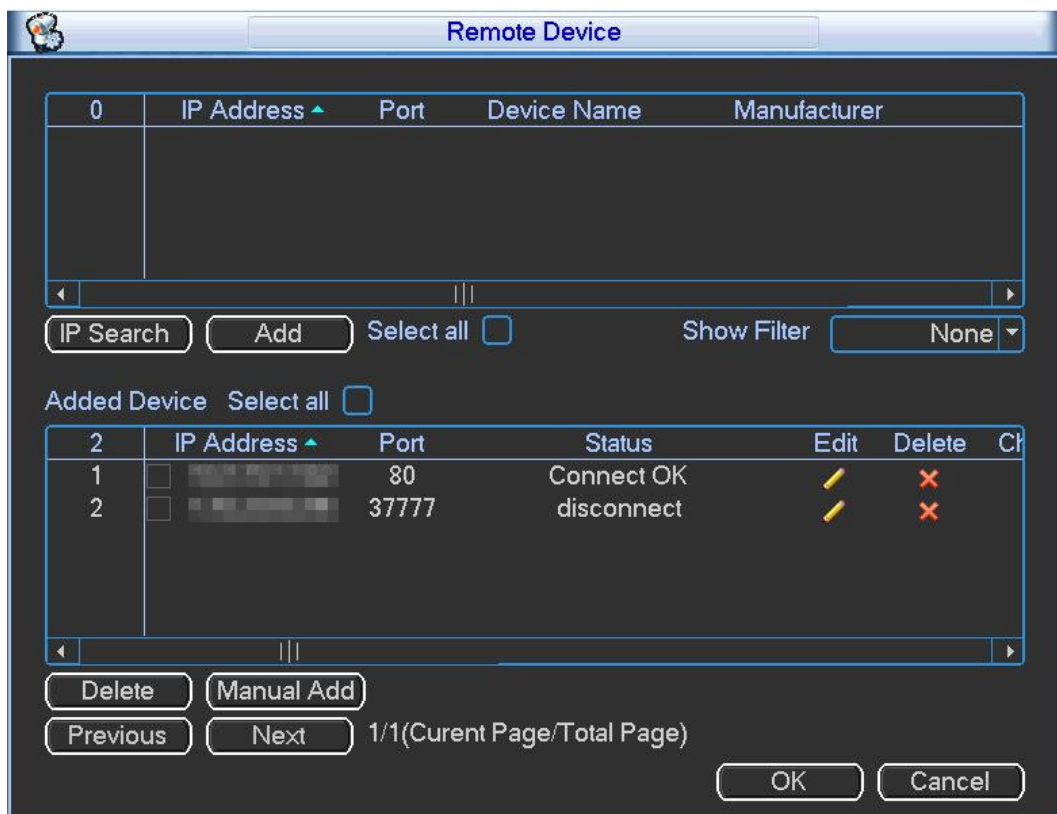

3.3.6.2 Search

Step 1 Click **IP Search**.

The searched devices are displayed.

Step 2 Tick the check box before one device, and then click **Add**.

The device will appear in the **Added Device** area.



Tick the check box of **Select all**, to select all devices.



In the drop-down list on the right of **Show Filter**, select filter criteria, and fill in the filter value, to search the filtered device information.

Step 3 Click **OK** to complete the settings.

3.3.6.3 Manual Add

Step 1 Click **Manual Add**.

Figure 3-12 Manual add

1	Channel Name	Channel Number
1	Channel_1	1

Step 2 Configure parameters according to your actual need.

Table 3-7 Manual add parameters description

Parameter	Description
Device Name	Fill in device name you want to add, and tick the check box to fill it with white, so as to enable the device.
Manufacturer	Select a manufacturer according to the actual situation. You can add manufacturers, including Private, Panasonic, Sony, Dynacolor, Samsung, AXIS, Sanyo, Pelco, Arecont, Onvif, Gosuncn, LG, Watchnet, Canon, PSIA, GB28181, AirLive and JVC.
IP Address	Enter the IP address of remote device.

Parameter	Description
TCP Port	TCP service port. The default setting is 37777. You can configure this parameter according to your actual situation.
Name and Password	Enter the user name and password to login the remote device.
Protocol	Select protocol of remote device.
Channel Amount	Select the channel number that you want to connect. You can select all channels.

Step 3 Click **OK** to complete the settings.
The device will appear in the **Added Device** area.

3.3.6.4 Editing Remote Device

Click . The **Edit** dialog box pops up. Refer to Table 3-7 to edit remote device information, and then click **OK**.

3.3.6.5 Deleting Remote Device

Click  or select an added remote device, and then click **Delete**.

3.3.7 System Info

You can view version info, online users and system status.

Figure 3-13 System info

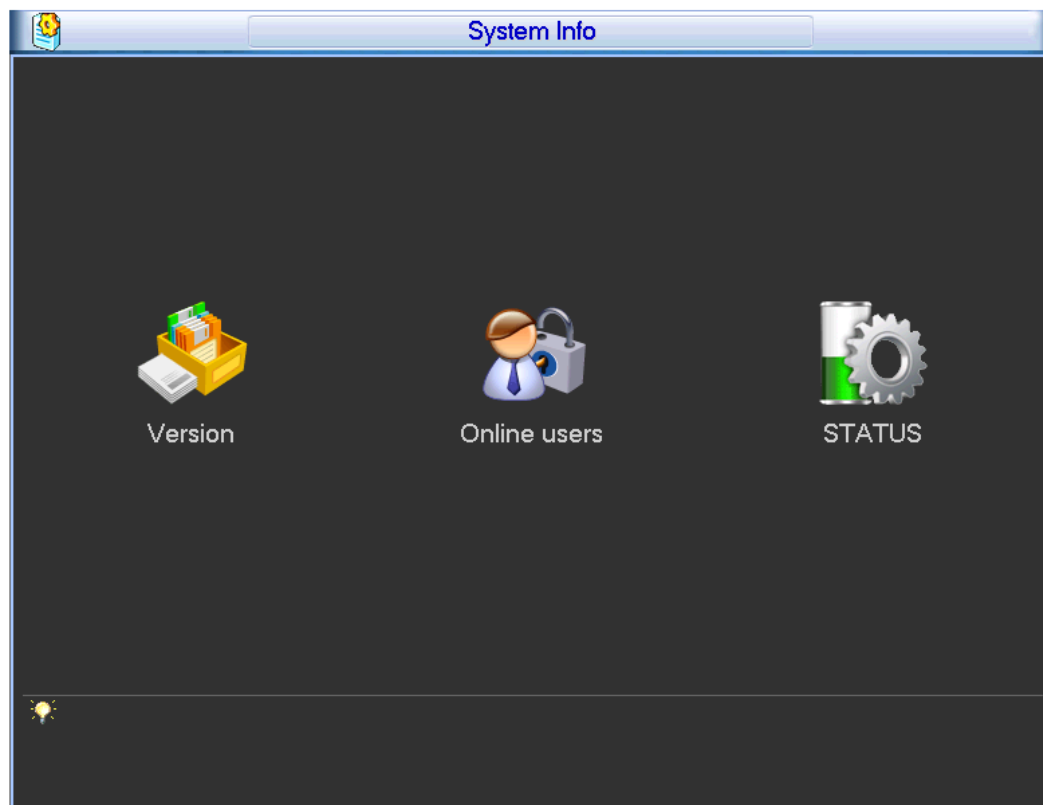

3.3.7.1 Version

In the main menu, select **System Info > Version**. You can view the version details such as system version, build date, web version and serial number.



For 1-channel 4K high definition (H.265) series, click **Version** on the **Main Menu** interface.

3.3.7.2 Online Users



1-channel 4K high definition (H.265) series does not support this function.

You can view online users that visit the decoder remotely.

In the main menu, select **System Info > Online users**. The **Online users** interface is displayed.

Figure 3-14 Online users

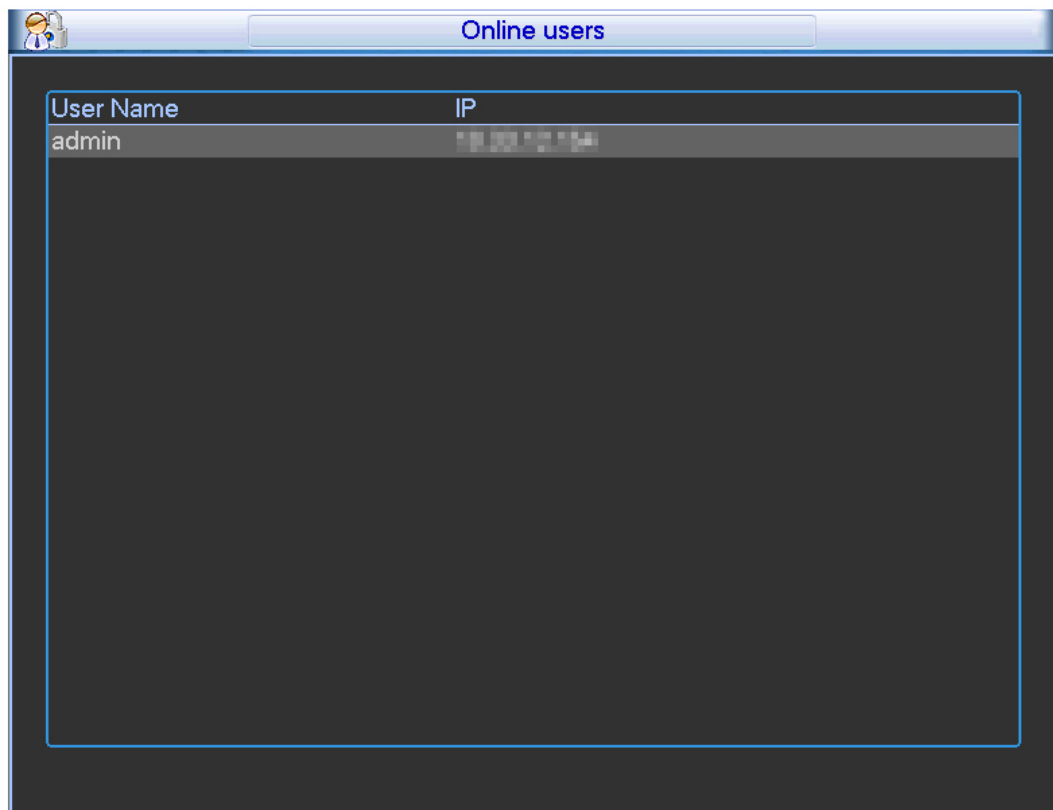

3.3.7.3 Status



1-channel 4K high definition (H.265) series does not support this function.

You can view fan speed, card, temperature and source information, device time, net percentage, CPU percentage and memory percentage.

In the main menu, select **System Info > Status**. The **Status** interface is displayed.

Figure 3-15 Status



Table 3-8 System status description

Parameter	Description
Fan Speed	Display the speed of two fans.
Card Information	Display information about cards in the slots, including card type, encoding or decoding card. Also, display present operating status, including data exchange and online status.
Temperature Information	Display present temperature and status of cards.
Source Information	Display the status of two powers.
Time	Display present time of decoder.
Net Percentage	Display the receiving and transmitting rate of each network port.
CPU Percentage	Display percentage of each CPU.
Memory Percentage	Display percentage of memory.

3.3.8 Shutdown

You can log out menu user, shut down, restart system and switch user.

In the main menu, select **Shutdown**. The **Shutdown** interface is displayed.

Figure 3-16 Shutdown

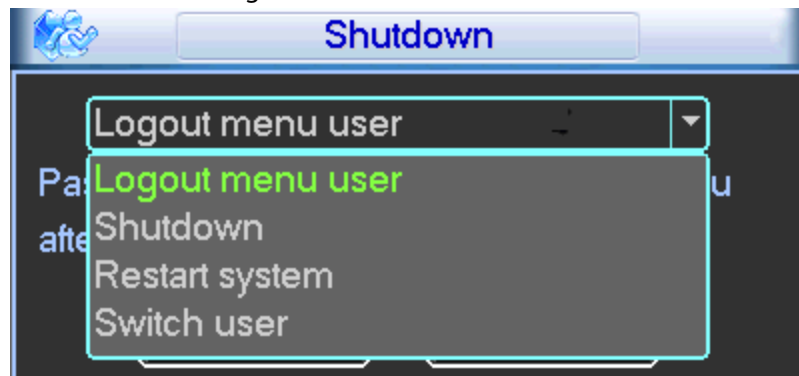

- Logout menu user: Exit the menu, and you need to input password to enter the menu again.
- Shutdown: Exit the system, and turn off power supply.

- Restart system: Exit the system, and restart the system.
- Switch user: Log out current user, and switch to another user.

4 Web Operations



This chapter takes 12/15/18/21-channel 4K high definition (h.265, with 4 input ports) series interfaces for example in most cases, which are just for your reference. 1-channel 4K high definition (h.265) series, 4-channel 8K high definition (H.265) series, 6-channel 4K high definition (h.265, with 4 input ports) series and 9-channel 4K high definition (h.265, with 4 input ports) series have slightly different interfaces. The actual product shall prevail.

4.1 Network Connection

Step 1 Connect the Ethernet port of the decoder and the PC NIC port with network cable.

Step 2 Set PC and decoder in the same IP segment.



Default IP address is 192.168.1.108.

Step 3 With computer, ping `***.***.***.***`(IP address of decoder) to check whether connection is OK or not. Usually the returned TTL value should be less than or equal to 64.

Step 4 Open the browser, enter IP address of decoder in the address bar, and then press Enter.



WEB controls can be recognized and downloaded automatically. System can download the latest Web controls and remove the old one.

After login the WEB interface, change IP address of decoder according to the actual situation. See "4.5.2 Network".

Step 5 Connect the decoder to network.

4.2 System Login

Step 1 Enter IP address of decoder in the address bar of the browser (take 192.168.1.108 for example). Enter `http://192.168.1.108` in the address bar, and then press Enter.

After connection succeeds, the **Device Initialization** interface is displayed.

Figure 4-1 Device initialization

Device Initialization	
Username	admin
Password	<input type="text"/>
	Low Middle High
Confirm Password	<input type="text"/>
OK	

Step 2 Set admin user's password.



The password can be set from 8 through 32 non-empty characters and contains at least two types from capital letter, lower-case letter, number, and special characters (excluding "", "", "", ";", ":", "&"). **Password** and **Confirm Password** shall be the same. Enter a strong password according to the password strength indication.

Step 3 Click **OK**.

The login interface is displayed.

Figure 4-2 Login

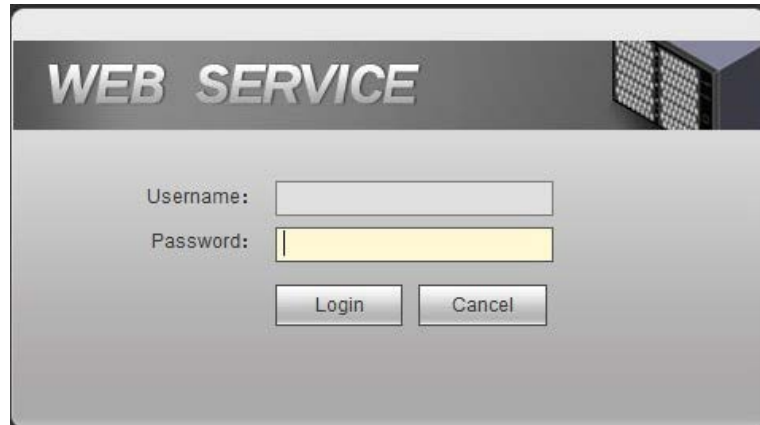

Step 4 Enter username and password, and then click **Login**.

Figure 4-3 Operation interface

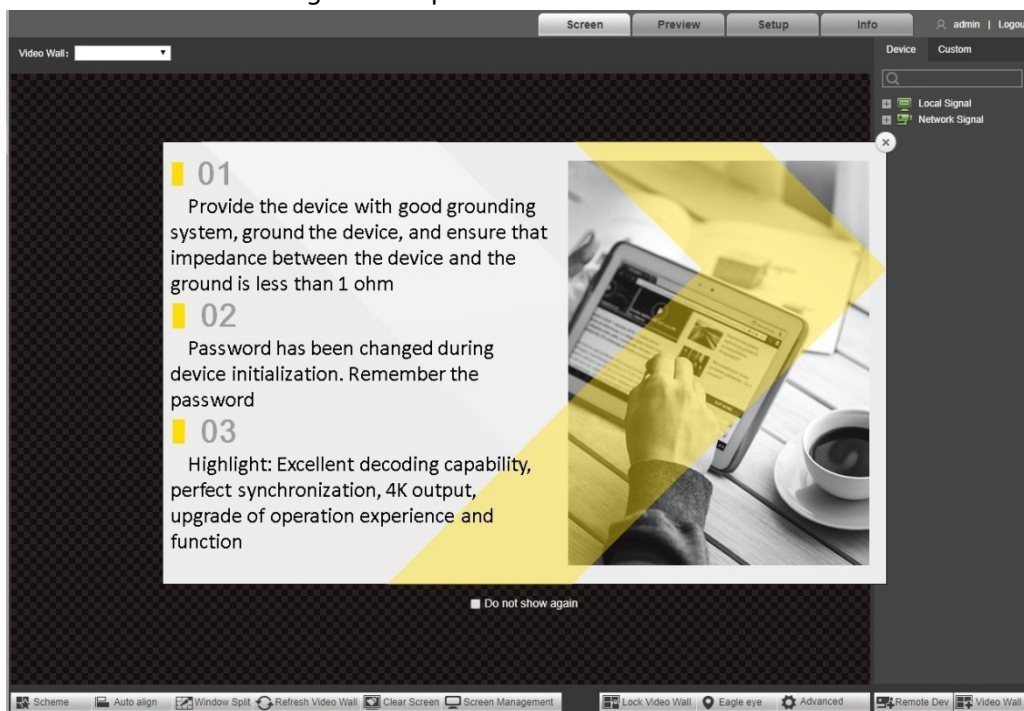

Step 5 View the points for attention and highlights on the page.



- Please conform to the points for attention.
- Click  to close the page.
- Tick "Do not show again", so this page will not show when you log in for the next time.

Step 6 Install or load controls as prompted by the system.



Click **Logout** to log out the system.

4.3 Screen



1-channel 4K high definition (H.265) series and 4-channel 8K high definition (H.265) series do not support local signals.

Click **Screen** tab. The **Screen** interface is displayed.

Figure 4-4 Screen

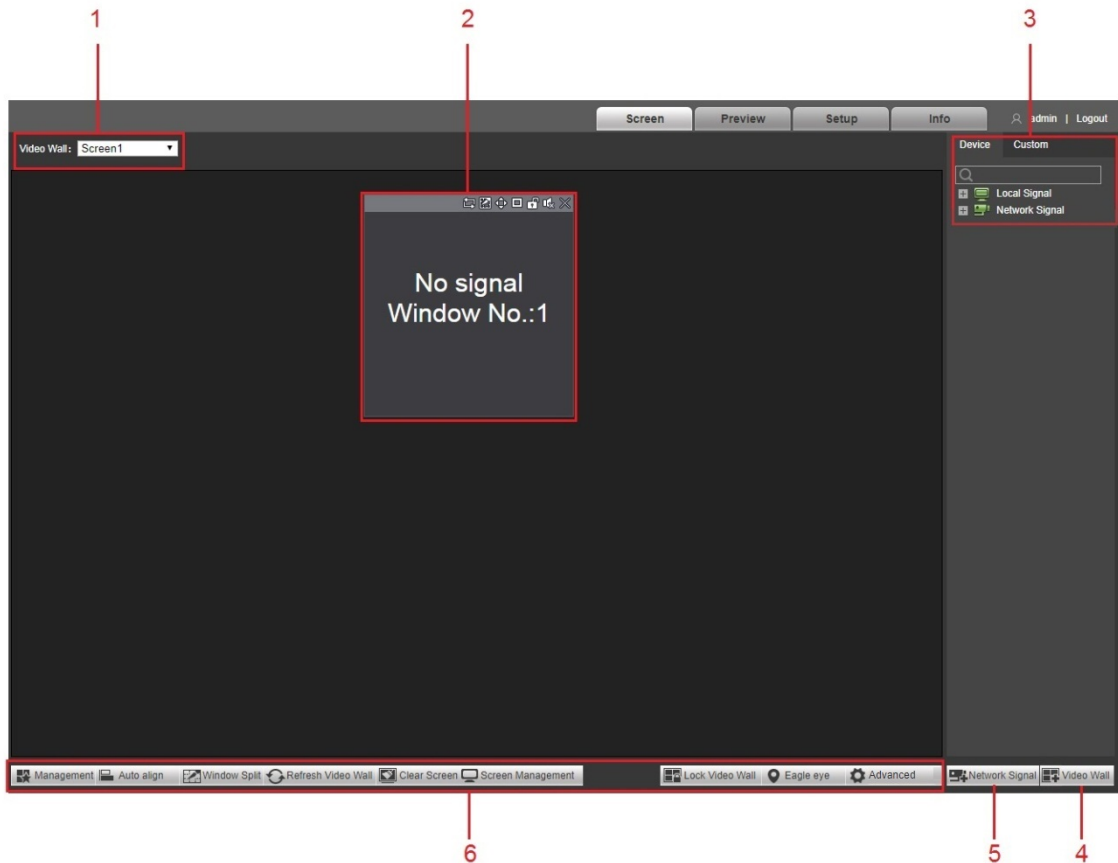

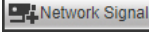



Table 4-1 Screen function description

No.	Name	Description
1	Video wall selection area	After you add a video wall, you can select the video wall in the drop-down list of Video Wall . See "4.3.1 Adding Video Wall."
2	Window configuration	Add window, adjust window, put the window at the bottom and turn off the signal. See "4.3.2 Window Configuration."
3	Signal management	Select different tabs to operate. <ul style="list-style-type: none"> In Device tab, you can view local signal and channel information, preview and display the signal on the video wall. <div data-bbox="700 1760 754 1800" data-label="Image"> </div> <p>1-channel 4K high definition (H.265) series and 4-channel 8K high definition (H.265) series do not support local signals.</p> In Custom tab, you can view signal group information, and configure signal tour on the video wall.

No.	Name	Description
4	Video wall	Click  to enter Video Wall Setup interface. You can add, modify and delete video wall. See "4.5.5.1 Video Wall Setup."
5	Network signal	Click  to enter Network Signal interface. You can add, modify and delete device. See "4.5.4.1 Network Signal."
6	Video wall management	You can carry out management, auto-align, window-split, refresh video wall, clear screen and screen management. Lock or unlock video wall. See "4.3.4 Video Wall Management ."  1-channel 4K high definition (H.265) series does not support video wall management.

4.3.1 Adding Video Wall

You need to add video wall when you login for the first time.

Figure 4-5 Adding video wall

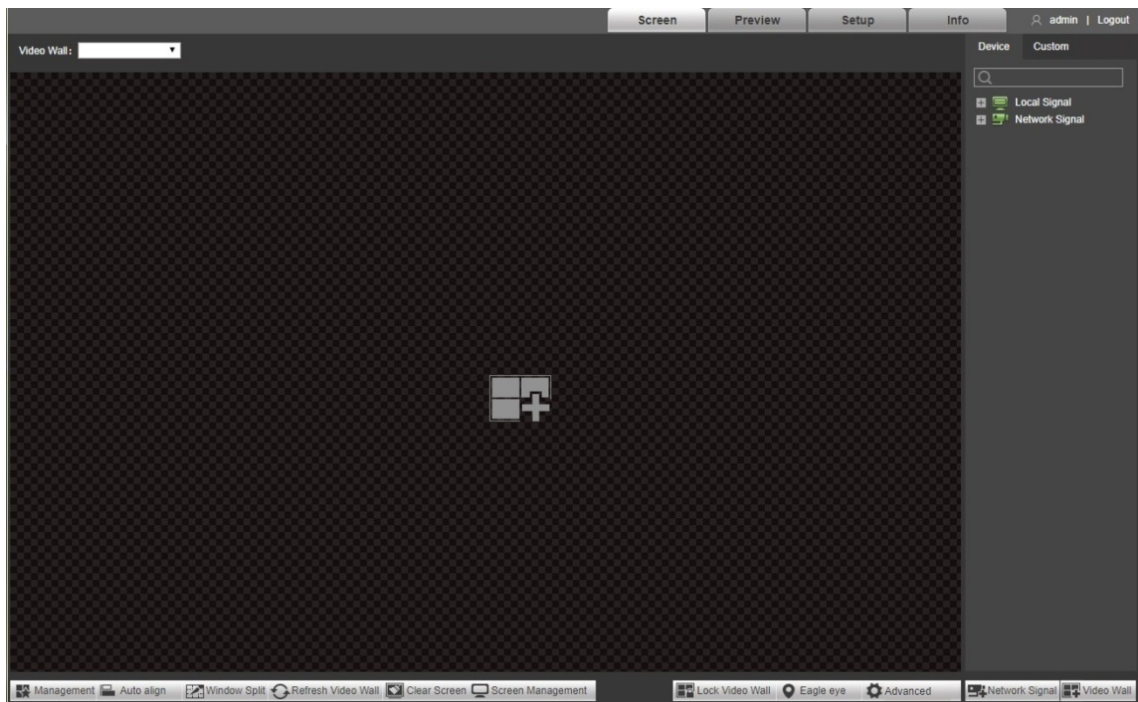

Click  in the center of interface to enter **Video Wall Setup** interface. See "4.5.5.1 Video Wall Setup".

4.3.2 Window Configuration

4.3.2.1 Adding a Window

Press and hold the left mouse button on the video wall, drag and form a window.

Figure 4-6 Adding a Window

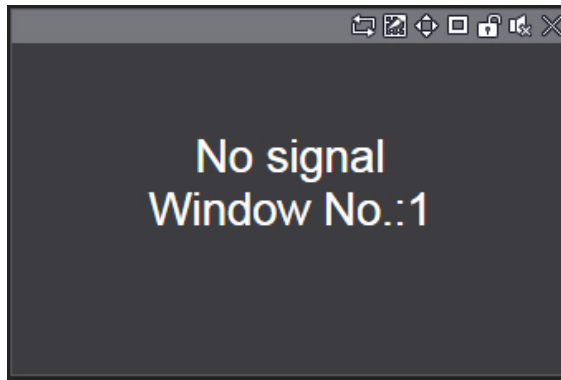

- Select a window, press and move the left mouse button. The selected window will be moved to the required position.
- Select a window, drag any direction control point to change the dimension of the selected window.
- Select a window, right-click and select **Bottom**. The selected window will be at the bottom of other windows.
- Select a window that is displaying signal, right-click and select **Signal Off**. The signal can be turned off.

4.3.2.2 Adjusting Window



The operation icons are displayed at the top right corner of the window.

Figure 4-7 Window adjustment icons



Table 4-2 Window adjustment icon description

No.	Name	Description
1	Start/stop signal tour	Click the icon to start signal tour, and the icon becomes . Click to stop signal tour. Configure the tour setting of signal. See "4.3.3.4 Signal Tour."
2	Split	Split the window, including 2-split (horizontal/vertical), 4-split, 9-split and 16-split. When the window is maximized or pasted to the screen, the icon becomes . Click the icon to drag the window anywhere.
3	Paste screen	Click the icon to paste the window to the screen.
4	Paste window	Click the icon, so the window will be pasted to surrounding windows.

No.	Name	Description
5	Lock	Click the icon to lock the window. Then, window position and size cannot be adjusted.  Click  to unlock the window.
6	Audio	N/A
7	Close	Click the icon to close this window.

4.3.2.3 Configuring Window Information

You can set window position and size according to your need.

Precondition

Manual setting window wide and height has been enabled. See "4.5.5.3.2 Global Setup".

Operation Steps

Step 1 Double click the window.

The **Window Information** interface is displayed.

Figure 4-8 Window information

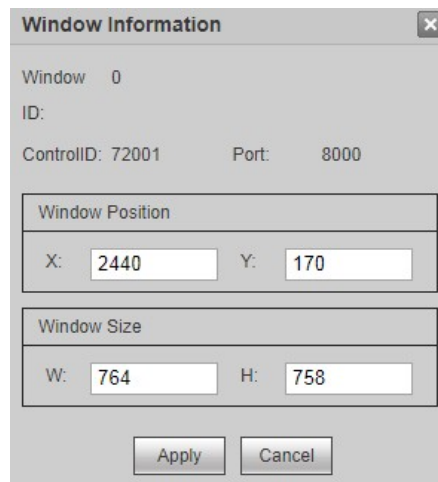

Step 2 Configure window position and window size.

Step 3 Click **Apply**.

The window position and size is adjusted according to the configuration.

4.3.3 Signal Configuration

You can select signal directly, or enter signal name in search bar to search signal.

4.3.3.1 Device Tree



1-channel 4K high definition (H.265) series does not support local signals.

Device tree displays all local signals and the added network signals.

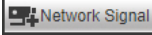
- Local signal: Display local signal sources. See "4.5.4.2 Local Signal."
- Network signal: Display the added signal sources. Click  to add. See "4.5.4.1 Network Signal."

4.3.3.2 Custom

You can customize signal group. **Custom** tab displays the added group and signal source. You can drag the signal group to the window for loop play of signals in the group. See "4.5.4.3 Signal Group".

4.3.3.3 Signal on Wall

Output a signal to a window on the video wall, and you can view video of the signal on the screen.

Step 1 Select a window on the video wall, or press and hold left mouse button to select an area on the video wall.

Step 2 Select signal source from **Device** or **Custom** tab. Take **Device** for example.

Figure 4-9 Select signal source

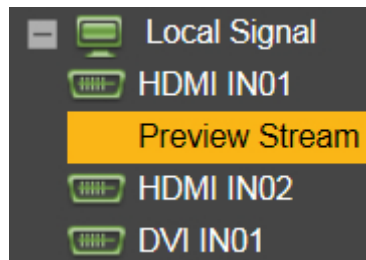

Step 3 Display signal on the video wall.

- Press and hold left mouse button, drag the signal to designated window, and the signal is output to the window.
- Select a window, double-click channel preview or main/sub stream, and the signal is output to the window.

4.3.3.4 Signal Tour

Drag the configured signal group to a window, to tour play the signals on the window. Set the stay time and stream type.



Configure signal group in **Collection** tab. See "4.5.4.3 Signal Group".

Step 1 Select a window to tour signal.





Step 2 In **Custom > Collection** interface, select a signal group, press and hold left mouse button to drag the signal group to designated window.

The window will start signal tour automatically.

Step 3 Click  at the bottom of the interface.

All signal information in the window is displayed.

Figure 4-10 Signal information

No.	IP	Channel Name	Stay Time :	Stream Type	Operation
1		Channel_1	10	Sub Stream1	  

Step 4 Set **Stay Time** and **Stream Type**.



- Click corresponding to one signal, and the signal will not appear in the tour queue, but the signal group still exists.
- Click or to adjust signal tour sequence.
- The setting takes effect immediately.
- Click at the top right corner of window, so you can stop signal tour.

4.3.4 Video Wall Management

You can manage the video wall, including scheme management, auto-align, window split, refresh video wall, clear screen, screen management, lock video wall, eagle eye and senior function.

4.3.4.1 Scheme Management

You can manage schemes and configure switch timer.

4.3.4.1.1 Video Scheme

Save video wall layout as a scheme, configure multiple schemes to be displayed on the screen in turn, and thus manage them.

Step 1 Click .

The **Video Scheme** interface is displayed.

Figure 4-11 Video scheme

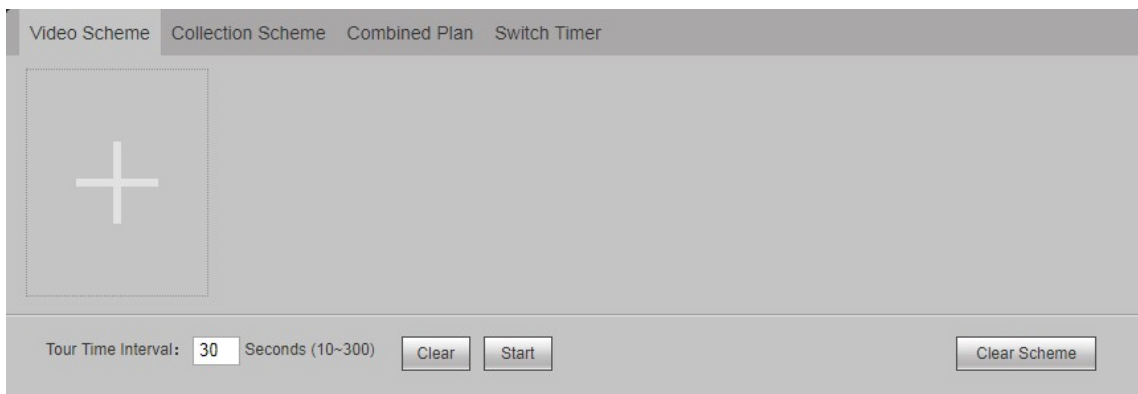

Step 2 Click to save the scheme.

Figure 4-12 Save video scheme

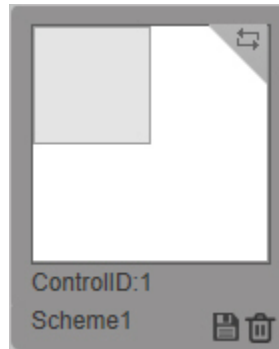



Step 3 Configure the current layout again, and repeat Step 2 to add more schemes.



Click **Clear Scheme** to clear all schemes.

Step 4 Set tour time interval. Default tour time interval is 30 seconds.

Step 5 Click  at the top right corner of each scheme to add the scheme to tour queue.

 turns into a number, meaning its sequence in tour queue.



Double-click **Control ID** and scheme name, and you can change them.

Figure 4-13 Set tour sequence.

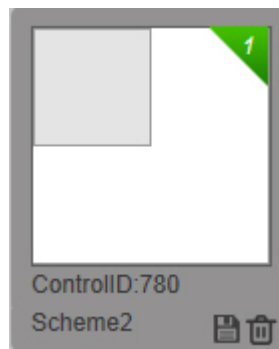

Step 6 Click **Start**.

Scheme tour starts, and tour information is displayed at the bottom right corner of the interface.

Figure 4-14 Tour information

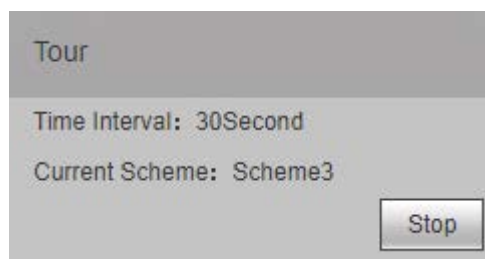

- Click **Stop** to stop tour.
- During scheme tour, video wall interface cannot be operated.
- Click **Clear** to clear the whole scheme tour plan.
- Control ID distinguishes different schemes when central control device issues commands.

4.3.4.1.2 Collection Scheme

Save virtual LED and background configuration to be a collection scheme. Multiple collection schemes can be displayed on the video wall in turn. See "4.3.4.1.1 Video Scheme".



See "4.3.4.9.2 Virtual LED" for virtual LED configuration, and "4.3.4.9.3 Background" for background configuration.

4.3.4.1.3 Combined Plan

According to your need, combine the video scheme and collection scheme into a combined plan, and display it on the video wall.

Step 1 Select **Combined Plan** tab.

The **Combined Plan** interface is displayed.

Figure 4-15 Combined plan

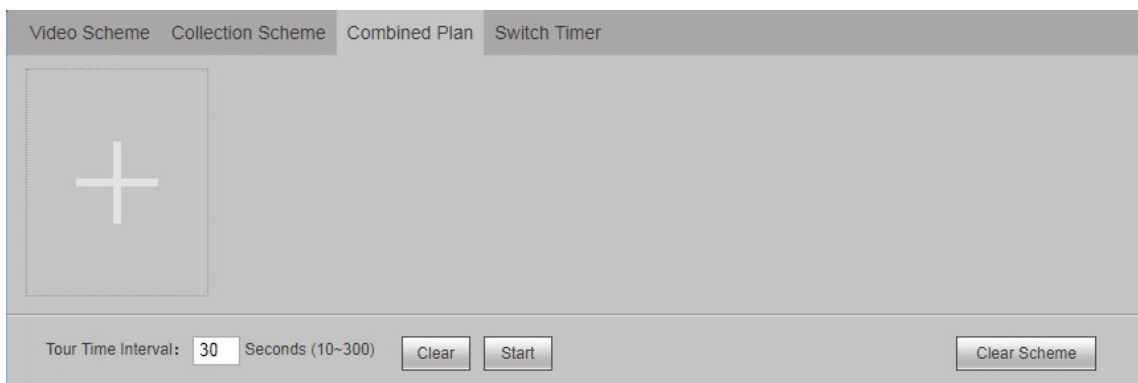

Step 2 Click .

The **Scheme Management** interface is displayed.

Figure 4-16 Scheme Management

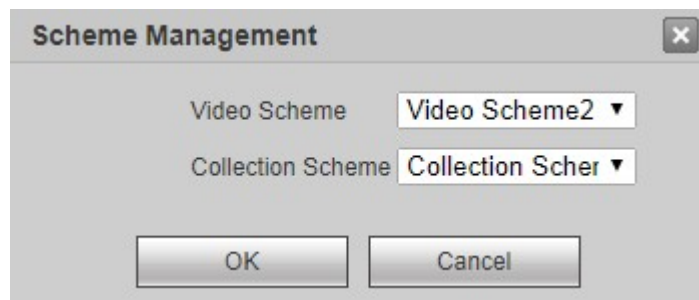

Step 3 Select video scheme and collection scheme you want.

Step 4 Click **OK** to save the combined plan.

Figure 4-17 Save combined plan

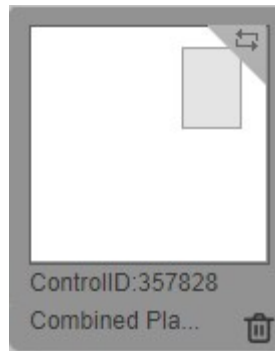

For other configurations, see "4.3.4.1.1 Video Scheme".

4.3.4.1.4 Switch Timer

After setting switch time for a scheme, the system will switch to this scheme automatically at the switch time.

Step 1 Select **Switch Timer** tab.

The **Switch Timer** interface is displayed.

Figure 4-18 Switch timer

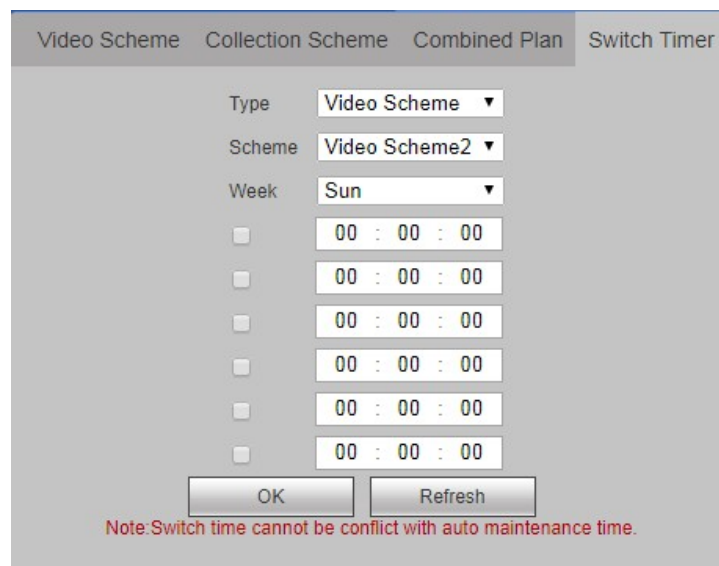

Step 2 Select **Type**, **Scheme** and **Week**, and then set switch time.



- Tick the check box, and the time point will take effect.
- Two scheme time periods shall not be the same.

Step 3 Click **OK**.

4.3.4.2 Auto-align

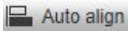
Click  **Auto align**, and all windows will be automatically aligned in the following way.

- Each window size is equal, under the precondition of filling the entire video wall.
- Windows are arranged horizontally from top to bottom.

Figure 4-19 Auto-align

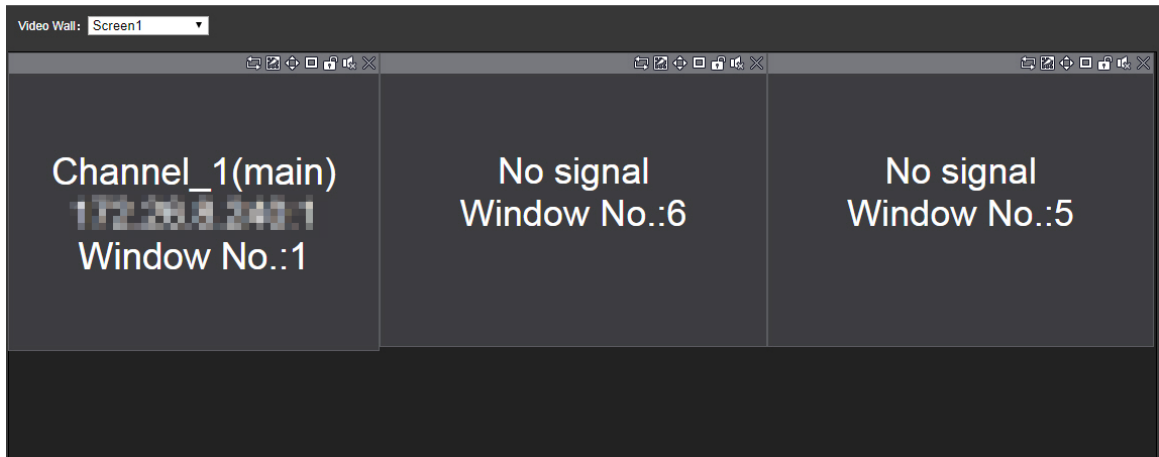

4.3.4.3 Window Split

Select block or window, and split according to split plan of the system or you can enter split number manually.

4.3.4.3.1 Block Division

During block division, the system clears previous block window, and divides the block according to the selected split. After block division, previous windows will be closed, and previous signal will not be kept.

Step 1 Select **Window Split > Block Division**.

The **Block Division** interface is displayed.

Figure 4-20 Block division (1)

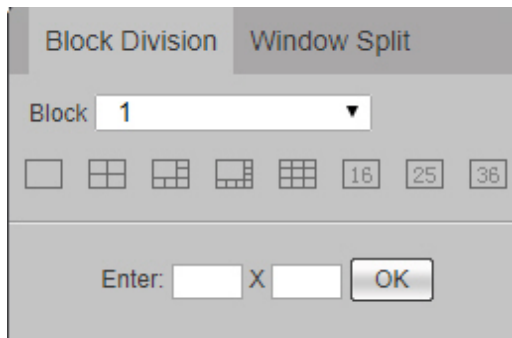
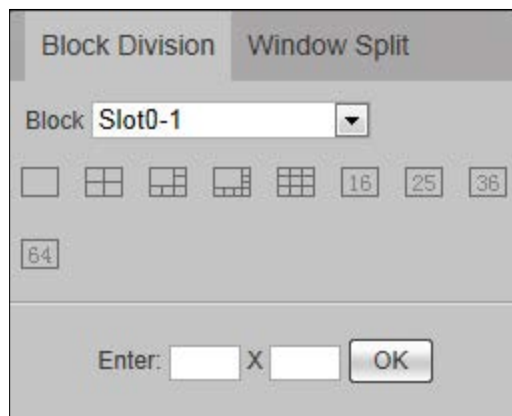



Figure 4-21 Block division (2)





The interface of 1-channel 4K high definition (H.265) series is shown in Figure 4-21. For other models, see Figure 4-20.

Step 2 Select the fixed split  or enter the split number manually (for example, 3×3 represents 9-split).



Only 1-channel 4K high definition (H.265) series supports 64-split.

Step 3 Click **OK**.
System pops up a prompt box.

Figure 4-22 Prompt box

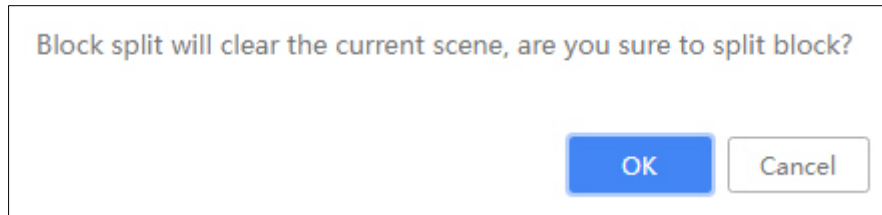

Step 4 Click **OK**.
The split blocks are displayed.



After block division, the window is locked by default. Click  to unlock the window, if you need to adjust window position and size.

Figure 4-23 Block division display



4.3.4.3.2 Window Split

Window split is to split the selected windows freely. Previous signal remains in the first window after splitting.

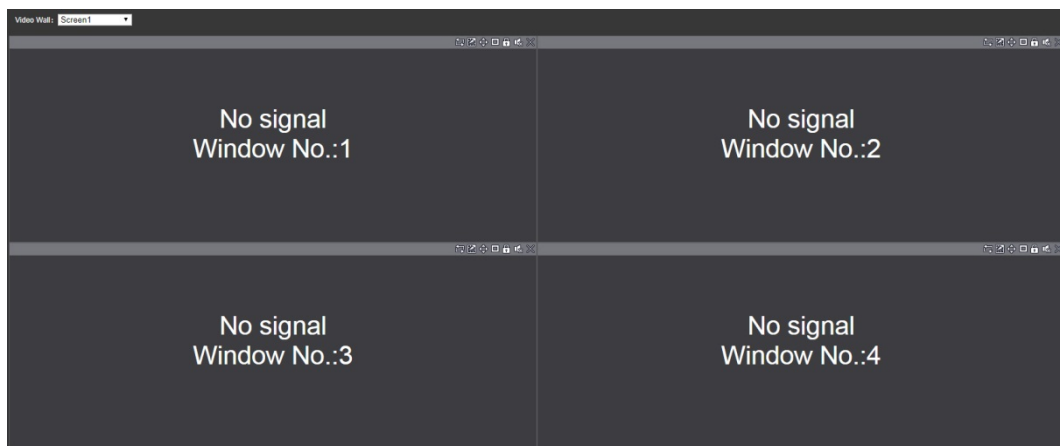
Step 1 Select a signal window.



It is suggested that four window should not be selected for window split.

Step 2 Select **Window Split > Window Split**.
The **Window Split** interface is displayed.

Figure 4-24 Window split (1)

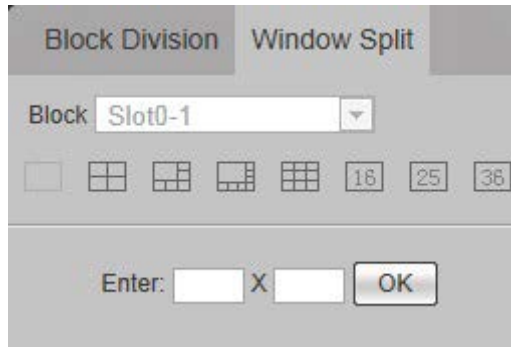
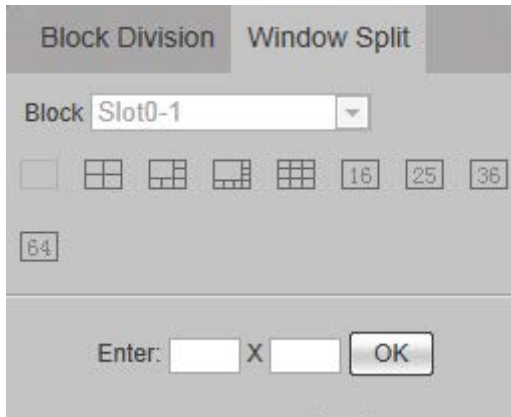





Figure 4-25 Window split (2)



The interface of 1-channel 4K high definition (H.265) series is shown in Figure 4-25. For other models, see Figure 4-24.

Step 3 Select the fixed split     or enter the split number manually (for example, 3×3 represents 9-split).



Only 1-channel 4K high definition (H.265) series supports 64-split.

Step 4 Click **OK**.
The split windows are displayed.



After window split, previous signal remains in the first window, while other windows display **No signal**.

Figure 4-26 Window split display

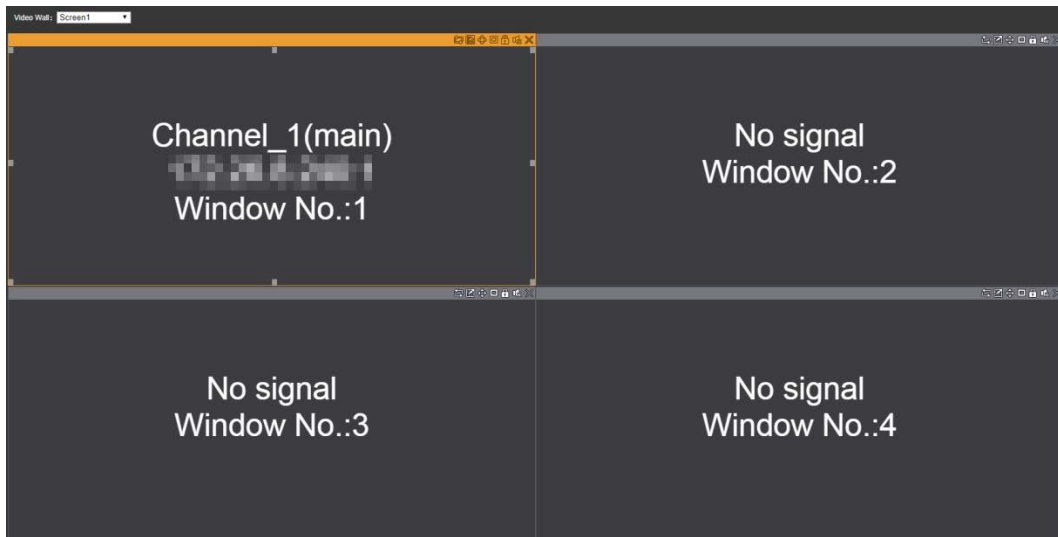

4.3.4.4 Refreshing Video Wall

Click  to refresh channel preview and layout information of current video wall.

4.3.4.5 Clearing Screen

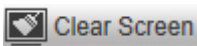
Click  to clear screen.

4.3.4.6 Screen Management

You can manage the screen, including controlling screen power, controlling power switch and adjusting screen parameters.



- Only DH-LED-N protocol supports to control the power switch and adjust screen, whereas LED-CLT protocol only supports power switch function. For screen protocol configuration, see "4.5.5.2.1 Screen Setup."
- 1-channel 4K high definition (H.265) series does not support screen management function at present.

4.3.4.6.1 Screen Power

According to requirement, connect the decoder with screen serial cable correctly, so you can turn on/off the screen. After the screen is turned off, it will be black.

Click . The **Screen Power** interface is displayed.

- Select a screen to turn on or turn off the screen.
- Select **All** to turn on or turn off the screens of all blocks.



Tick the check box of **All**, to select all screens or blocks.

Figure 4-27 Screen management

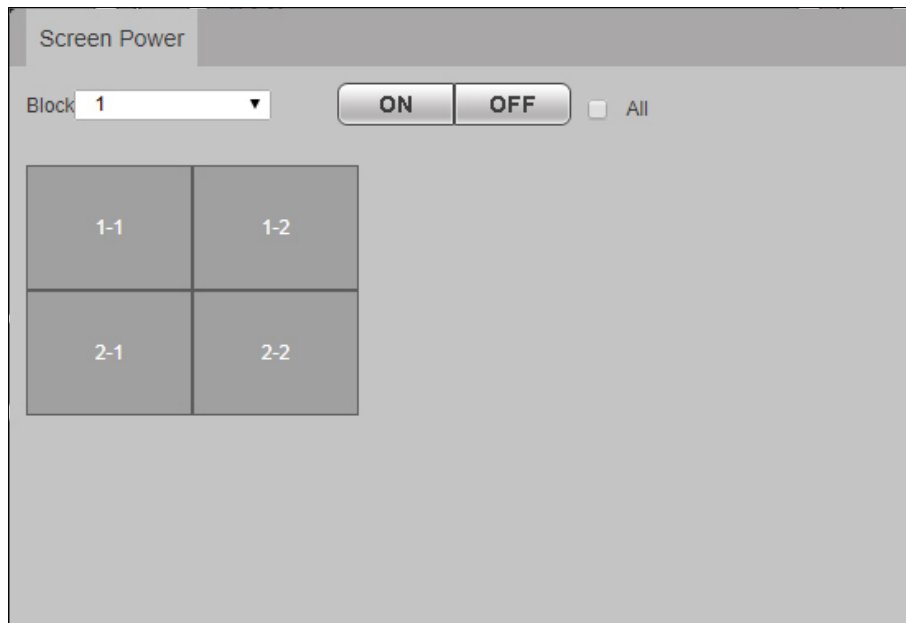

Step 1 Select a block from the drop-down list of **Block**.

Step 2 In the block, select one or more screens, and then click **ON** or **OFF** to turn on or turn off the screen.

4.3.4.6.2 Power Switch

According to the requirement, connect the decoder with serial port cable of LED screen, to control the power of LED screen.



If manufacturer protocol is DH-LED-N or LED-CLT, video signal can be displayed on LED. When **Power Switch** tab is displayed in **Screen Management** interface, the system can control LED power to turn on/off.

Select **Power Switch**. The **Power Switch** interface is displayed.

Figure 4-28 Power switch

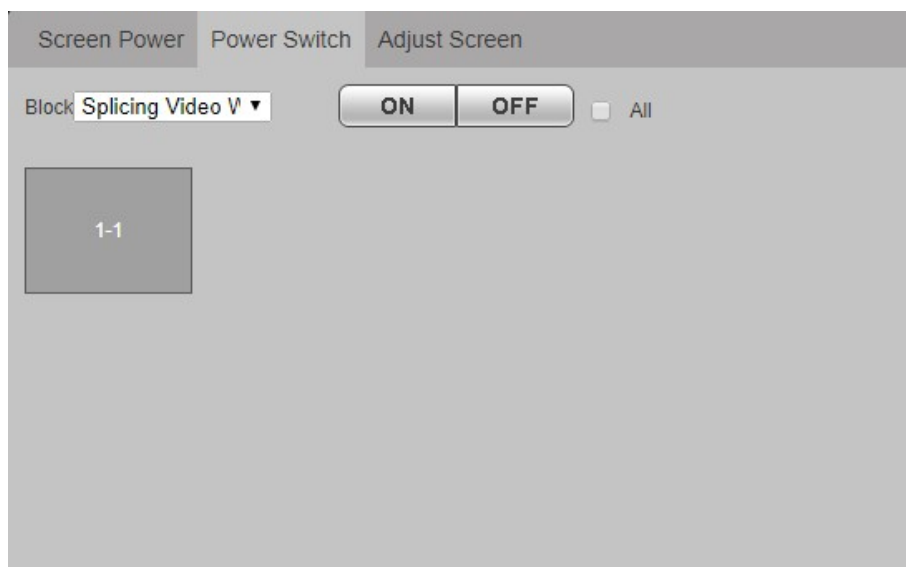

4.3.4.6.3 Adjusting Screen

You can configure brightness, color temperature and other parameters of LED corresponding to output signal, and adjust screen display.



If manufacturer protocol is DH-LED-N, the **Adjust Screen** tab is displayed in **Screen Management** interface, so you can adjust LED parameters.

Select **Adjust Screen** tab. The **Adjust Screen** interface is displayed.

Figure 4-29 Adjust screen

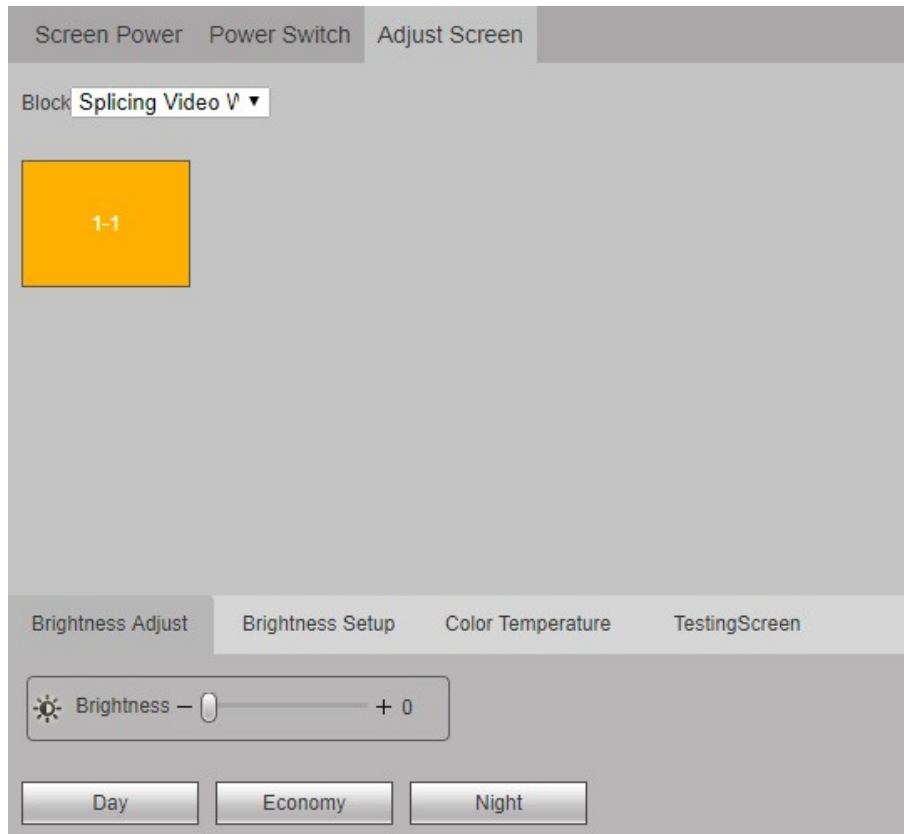

Configure screen display parameters, depending on the hardware of display device.

4.3.4.7 Locking Video Wall

Click  **Lock Video Wall**, and the video wall will be locked. The user cannot adjust relative position of the window. Click it again to unlock the video wall.

4.3.4.8 Eagle Eye

Eagle eye, also known as eagle eye map and thumbnail, is used to adjust display size and area of main window on the web screen.

Click  **Eagle eye**. The **Eagle Eye** interface is displayed.

Figure 4-30 Eagle eye

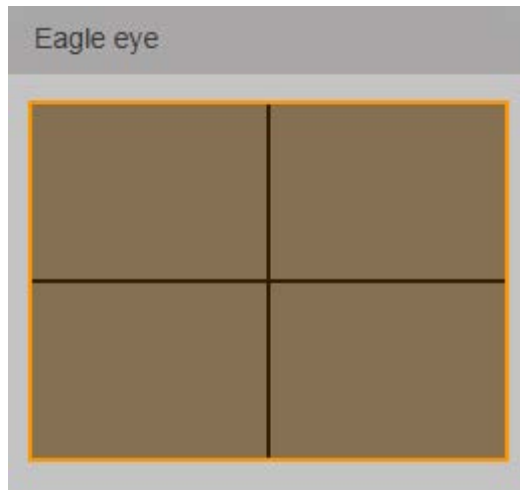

Adjust area box size in the eagle eye map with mouse or scroll wheel, to change main window display area size. Drag area box position in the eagle eye map, to change main window display area.



1-channel 4K high definition (H.265) series, 4-channel 8K high definition (H.265) series, 6-channel 4K high definition (H.265, with 4 input ports) series and 9-channel 4K high definition (h.265, with 4 input ports) series are slightly different. The actual interface shall prevail.

4.3.4.9 Advanced Function

You can configure advanced functions, including PTZ control, virtual LED, background, decoding strategy and show screen ID.

4.3.4.9.1 PTZ Control

PTZ control is to turn the PTZ device (up, down, left, right, top left, bottom left, top right and bottom right), carry out focus, zoom and iris operations.











Select display window unit of the signal, click  Advanced , and then click  . The **PTZ Control** interface is displayed.

Figure 4-31 PTZ control



Table 4-3 PTZ control parameter description

Parameter	Description
Direction control	Control PTZ to turn in eight directions, including up, down, left, right, top left, bottom left, top right and bottom right.
Step	Control PTZ turning speed. 1–8 steps can be set.
Zoom	Click  or  to adjust zoom.
Focus	Click  or  to adjust definition.
Iris	Click  or  to adjust brightness.
PTZ menu	<ul style="list-style-type: none"> Click  to open PTZ menu of preview interface. Then, select different functions with direction key, to operate PTZ. Click  to turn off the PTZ menu of preview interface.

4.3.4.9.2 Virtual LED

Divide a customized area on the video wall, enter any characters, and display them on the screen.

Step 1 Click .

The system displays virtual LED interface.



1-channel 4K high definition (H.265) series, 6-channel 4K high definition (H.265, with 4 input ports) series and 9-channel 4K high definition (h.265, with 4 input ports) series are slightly different. The actual interface shall prevail.

Figure 4-32 Open virtual LED

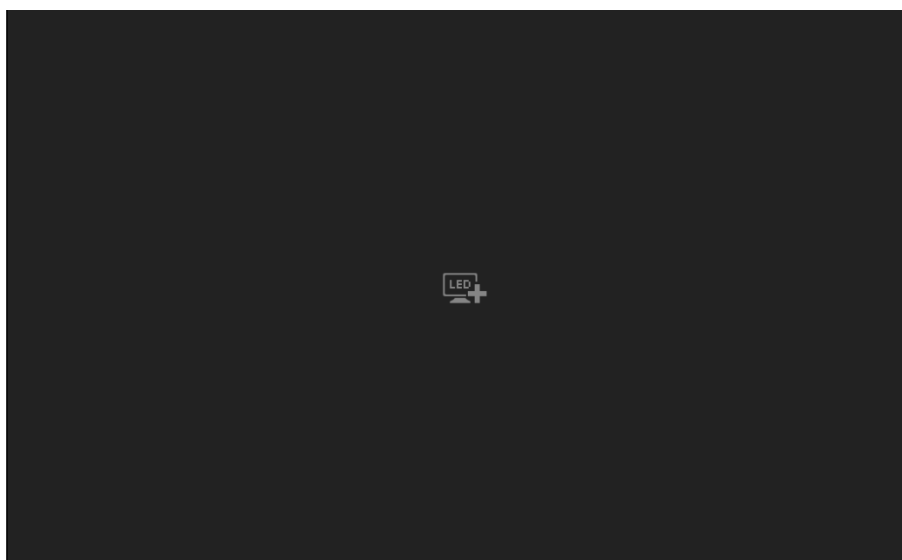

Step 2 Click  to add virtual LED.

The system displays **Virtual LED** interface.

Figure 4-33 Virtual LED

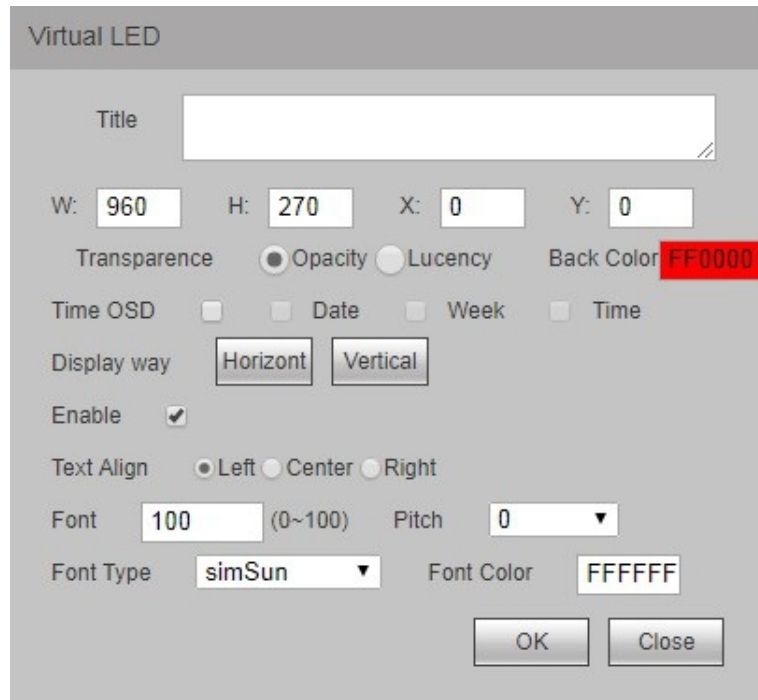

Step 3 Configure parameters.

Table 4-4 Virtual LED parameter description

Parameter	Description
Title	Enter the title of virtual LED, which will be displayed on the video wall.
W/H	Enter width and height of virtual LED.
X/Y	Enter coordinate of virtual LED.
Transparence	Enter transparence of virtual LED.
Back color	Configure background color of virtual LED. You can enter 6-digit RGB value manually, or click the color area to select.
Time OSD	Select the left check box to enable the function. Date , Week and Time are displayed by default. Please select time display type according to your need.  Select at least one item from Date , Week and Time .
Display way	Configure display way of the title, including Horizontal or Vertical .
Enable	Choose to display the title on video wall or not. <ul style="list-style-type: none"> Select the check box and click OK. The title will be displayed on video wall. De-select the check box and click OK. The title will be displayed on web, rather than video wall.
Text align	Configure alignment of the title against the background, including Left , Center and Right .
Font	Configure the title font from 0 to 100.
Pitch	Configure the title character distance from 0 to 5.
Font type	Configure the title font type, including simSun and simHei.
Font color	Configure the title color. You can enter 6-digit RGB value manually, or click the color area to select.

Step 4 Click **OK**.

Virtual LED displays the title.



- Move your mouse onto virtual LED, press and hold left mouse button, and move. The virtual LED can be moved to other places.
- Click virtual LED, drag any direction control point to change the size of virtual LED.

Figure 4-34 Effect



4.3.4.9.3 Background

Upload a picture to the system, and configure it to be screen background, so the picture is displayed in the screen as a background.



Background can only be selected from pictures that have been uploaded to the system. See "4.5.1.6 Picture Management".

Step 1 Click , and then click .

The **Background Setup** interface is displayed.

Figure 4-35 Add background

Background Setup

Block

Picture Name

Enable

OK



1-channel 4K high definition (H.265) series, 6-channel 4K high definition (H.265, with 4 input ports) series and 9-channel 4K high definition (h.265, with 4 input ports) series are slightly different. The actual interface shall prevail.

Step 2 Select **Block** and **Picture Name**, and select **Enable**.

Step 3 Click **OK**.

4.3.4.9.4 Decoding Strategy

Drag the slider to adjust window fluency, and thus balance real-time decoding and fluency (only network signal supports this function).

Step 1 Select a network signal window, click , and then click .

The **Decoding Strategy** interface is displayed.

Figure 4-36 Decoding strategy

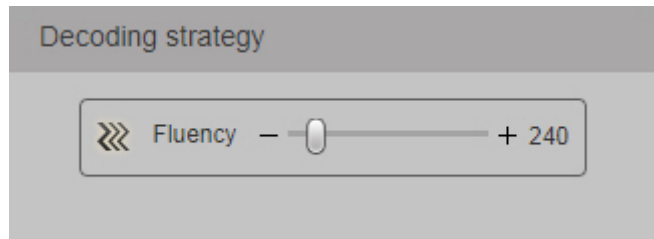

Step 2 Drag the slider to adjust window fluency.

Greater fluency value represents lower definition of the image and larger delay. Please set it according to actual conditions.

4.3.4.9.5 Show Screen ID

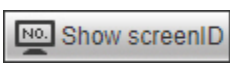
Click  to show screen ID on the video wall. Click it again to hide screen ID.

4.4 Preview



1-channel 4K high definition (H.265) series and 4-channel 8K high definition (H.265) series do not support local signal.

Select **Preview** tab. The **Preview** interface is displayed.

Figure 4-37 Preview

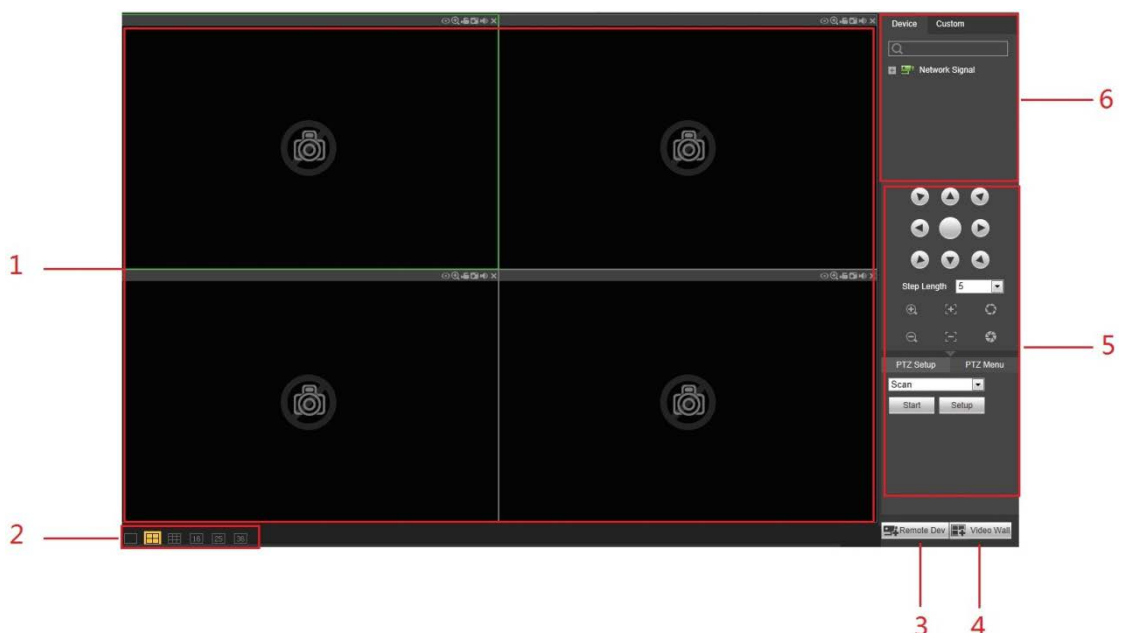
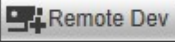



Table 4-5 Function description of preview interface

No.	Name	Description
1	Window	Preview video in the window. See "4.4.1 Window Function."
2	Window split	Carry out single split, 4-split, 9-split, 16-split, 25-split and 36-split of the window.
3	Remote device	Click  to enter Network Signal interface. You can add, modify and delete device. See "4.5.4.1 Network Signal."
4	Video wall	Click  to enter Video Wall Setup interface. You can add, modify and delete video wall. See "4.5.5.1 Video Wall Setup."
5	PTZ control area	Operate cameras with PTZ function. See "4.4.3 PTZ Control."
6	Signal configuration area	Configure signals. See "4.4.2 Signal Configuration."

4.4.1 Window Function

There are functions at the top right corner of the window.

Figure 4-38 Window function



Table 4-6 Functional description

No.	Name	Description
1	Fisheye	It is not supported at present.

No.	Name	Description
2	Partial zoom in	<ul style="list-style-type: none"> When the video is in the original status, click the icon, press and hold on left mouse button to select any area. The selected area will be zoomed in. When the video is zoomed in, press and hold on left mouse button to drag the video image. Click right mouse button to restore original status. Click the icon to zoom in and zoom out the video image with wheel button.
3	Local record	Click the icon to record the video. The recorded video file is saved in the recorded video path as configured in "4.5.1.10 Storage Path".
4	Snapshot	Click the icon to take a snapshot. The snapshot file is saved in the snapshot path as configured in "4.5.1.10 Storage Path".
5	Turn on Sound	Click the icon to turn on sound of the video.
6	Close Video	Close this window.

4.4.2 Signal Configuration

After adding a signal, you can view signal information or the added signal group information, and configure signal preview.

4.4.2.1 Device Tree

Device tree displays all the added network signals.

Network signal: Display the signal sources added on the **Remote Device** interface. See "4.5.4.1 Network Signal".

4.4.2.2 Custom

You can customize signal group. **Custom** tab displays added group and signal source. You can drag signal group to the window for loop play of signals in the group. See "4.5.4.3 Signal Group".

4.4.2.3 Image Preview

Add signal to preview window, so you can preview the video in preview window.

Step 1 Select a preview window.

Step 2 Select signal source in **Device** or **Custom**, and click the signal source to preview image in the corresponding window.

4.4.3 PTZ Control Panel

PTZ control is used to adjust the direction of the PTZ device, carry out scan, preset point, point tour, pattern and other settings. For details, see "4.3.4.9.1 PTZ Control".

Figure 4-39 PTZ Control

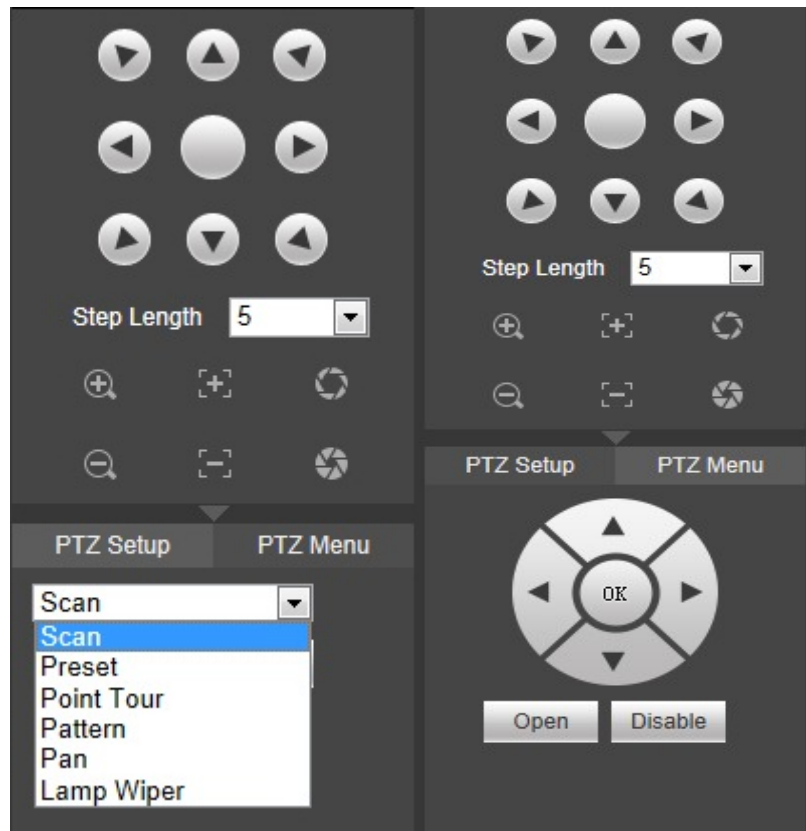

Table 4-7 PTZ parameters description

Parameter	Description
Scan	<ul style="list-style-type: none"> Click Setup, turn the camera with direction buttons, and click Set Left Border and Set Right Border to set left and right borders of PTZ scan. Click Start, and PTZ starts to scan. Click Stop, and PTZ stops scanning.
Preset	<ul style="list-style-type: none"> Determine a point, and then click Add to add a preset point. In the input box, enter the preset value, and then click View; the camera moves to the location of preset point.
Point Tour	<ul style="list-style-type: none"> Enter preset point number, and then click Add to add this preset point after the last preset point of this tour path. In the input box, enter tour path, and click Start to start tour. Click Stop to stop tour.
Pattern	<ul style="list-style-type: none"> Click Add, and you can configure a new pattern path with Start Record and Stop Record. Enter the pattern value, and then click Start to start pattern. Click Stop to stop the pattern.
Pan	Click Start , and PTZ starts to pan. Click Stop , and PTZ stops panning.
Lamp Wiper	Click Enable to enable the lamp and wiper, and click Disable to disable the lamp and wiper.

4.5 Setup

4.5.1 System Config

On this interface, you can complete general setting, user management, config backup, auto maintenance, system upgrade, picture management, fan control, comm setup, safe management and storage path.

4.5.1.1 General

You can configure basic information of the device, such as device information and system date.

4.5.1.1.1 Setting of General Information

Set device name, no. and so on.

Step 1 Select **Setup > System Config > General > General**.

The **General** interface is displayed.

Figure 4-40 General

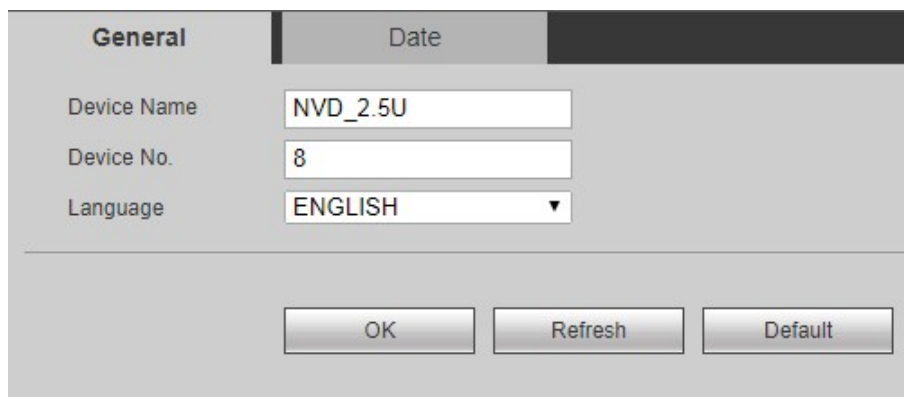

Step 2 Configure parameters.

Table 4-8 General parameters description

Parameter	Description
Device Name	Set device name. Device name is different depending on device model. The actual interface shall prevail.
Device No.	Set device Number.
Language	System language is determined by program package.

Step 3 Click **OK**.

4.5.1.1.2 Date

You can configure the system date, and choose to enable NTP (Network Time Protocol) or not. After enabling NTP function, device can automatically synchronize time with the NTP server.

Step 1 Select **Setup > System Config > General > Date**.

The **Date** interface is displayed.

Figure 4-41 Date

Step 2 Configure parameters.

Table 4-9 Date parameters description

Parameter	Description
Date Format	Select date display format you want.
Time Format	Select time format you want.
Date Separator	Select date separator you want.
System Time	Set system time. Click Sync PC to synchronize with current PC time.
Sync Device Time	Select the check box to enable function to synchronize remote device time.
DST	Select the check box to enable DST.
DST Type	Select DST type, including Date and Week .
Start Time/End Time	<ul style="list-style-type: none"> When DST Type is Date, enter year, month, day, start time and end time. When DST Type is Week, select month, week, start time and end time from the drop-down list.
NTP Setup	Select the check box to enable NTP sync function.
Time Zone	Select time zone.
Server	Enter server address or domain name.
Port	Enter the port number of NTP server.
Interval	Set the interval to update NTP server.

Step 3 Click **OK**.

4.5.1.2 User Management

User management adopts two-level management mode: user and user group. You can manage their basic information (only those with user management authority can operate user management).

- User name and group name support maximum 6 characters and can only be consisted of letter, number, and underline (_).
- The password can be set from 8 through 32 non-empty characters and contains at least two types from capital letter, lower-case letter, number, and special characters (excluding "", "", ";", ":" and "&"). The user with authority can modify his/her own password, but also modify the password of other users.
- According to factory defaults, maximum user quantity is 64, while maximum user group quantity is 20.
- There are two-level management modes: user and user group. Group name and user name shall be unique. One user can only belong to one group.
- Current user cannot modify his/her own authority.
- During initialization, there is 1 default user— admin. Admin is defined as high-authority user when leaving factory.

4.5.1.2.1 User

You can manage user information. Add, modify and delete user, modify user password.



The Authority list is different depending on device model. The actual interface shall prevail.

Select **Setup > System Config > User Management > User Management > User**. The **User** interface is displayed.

Figure 4-42 User

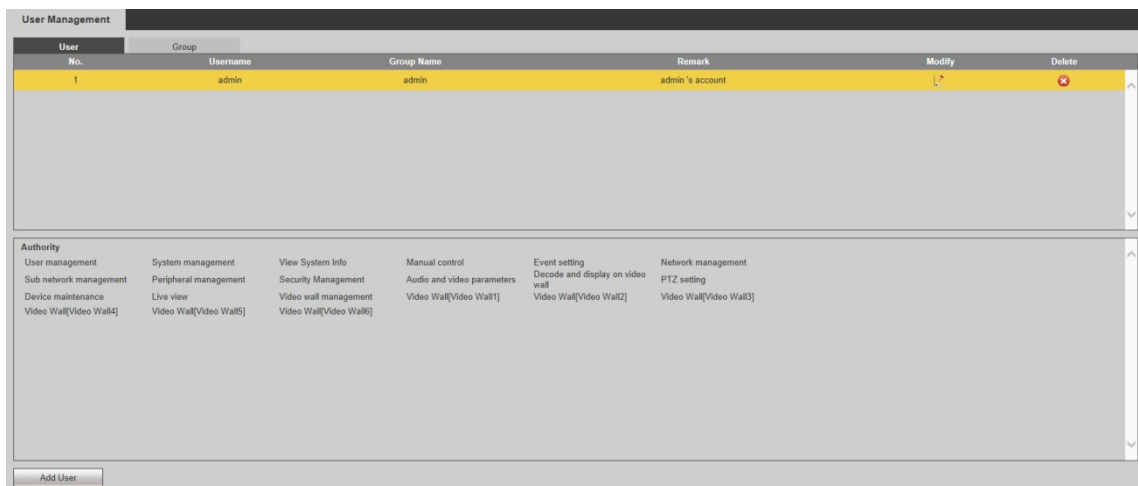

Adding User

Add one user to the group, and configure user authority control.

As default user with the highest authority, admin cannot be deleted.

Step 1 Click **Add User**.

The **Add User** interface is displayed.

Figure 4-43 Add User

The 'Add User' dialog box includes the following fields and options:

- Username: [Text Input]
- Password: [Text Input] with strength indicators: Low, Middle, High
- Confirm Password: [Text Input]
- Group: [Dropdown Menu] (selected: admin)
- Remark: [Text Input]
- Authority** section (all items checked):
 - All
 - User management
 - Event setting
 - Peripheral management
 - PTZ setting
 - Video Wall[Video Wall1]
 - Video Wall[Video Wall5]
 - System management*
 - Network management
 - Security Management
 - Device maintenance
 - Video Wall[Video Wall2]
 - Video Wall[Video Wall6]
 - View System Info*
 - Sub network management
 - Audio and video parameters
 - Live view
 - Video Wall[Video Wall3]
 - Video Wall[Video Wall4]
 - Manual control
 - Decode and display on video wall
 - Video wall management

Note: item with "*" is parent directory.

Buttons: OK, Cancel

Step 2 Enter username, password, confirm password and note, and then select group.



- When selecting a group for a user, authority of the user can only be a subset of the group, and should be no higher than the group authority.
- To conveniently manage the user, it is suggested that general user authorities shall be lower than high-level user authorities.

Step 3 In the **Authority** list, select operating authorities for the user.

- Select the check box to enable the authority.
- Select **All** to select all authorities.

Step 4 Click **OK**.

Modifying User

Step 1 Click  corresponding to the user you want to modify.

The **Modify User** interface is displayed.

Figure 4-44 Modify User

Modify User

Username: admin

Share:

Remark: admin 's account

Group: admin

Modify Password

Authority

- All
- User management
- System management*
- View System Info*
- Manual control
- Event setting
- Network management
- Sub network management
- Peripheral management
- Security Management
- Audio and video parameters
- Decode and display on video wall
- PTZ setting
- Device maintenance
- Live view
- Video wall management
- Video Wall[Video Wall1]
- Video Wall[Video Wall2]
- Video Wall[Video Wall3]
- Video Wall[Video Wall4]
- Video Wall[Video Wall5]
- Video Wall[Video Wall6]

Note: item with "*" is parent directory.

OK Cancel

Step 2 Modify user information.



Default user can only modify password, rather than other information.

Step 3 Click **OK**.

Modifying Password

Step 1 Click  corresponding to the user you want to modify.

Step 2 Select Modify Password.

Step 3 Enter old password, new password and confirm password.

Step 4 Click **OK**.

Deleting User

Click  corresponding to the user you want to delete.

4.5.1.2.2 Group

Different users may have different authorities to access the device. You can divide the users with the same authority into one group. It is easy for you to maintain and manage the user information. You can manage group information. Add and delete group, and modify group password. See "4.5.1.2.1 User".

Select **Setup > System Config > User Management > User Management > Group**. The **Group** interface is displayed.



The **Authority** list is different depending on device model. The actual interface shall prevail.

Figure 4-45 Group

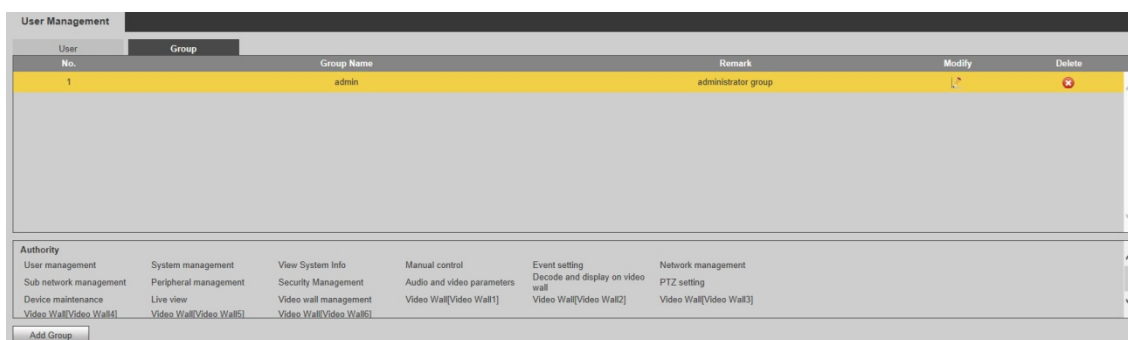

4.5.1.3 Config Backup

The configuration file of network video decoder can be exported to flash drive for backup. When the network video decoder goes wrong, you can import configuration file to restore configuration quickly.

Select **Setup > System Config > Config Backup**. The **Config Backup** interface is displayed.

Figure 4-46 Config backup

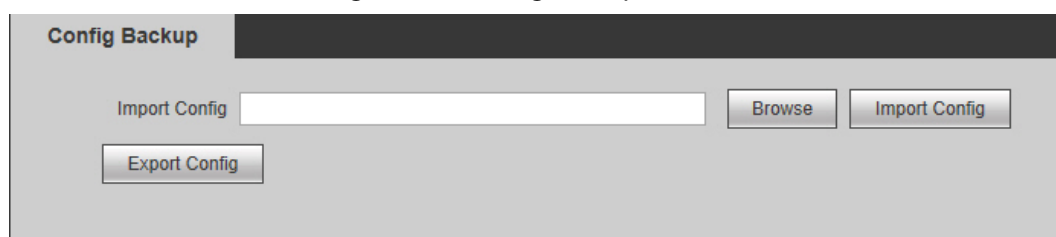

- Click **Import Config**, and then select configuration file (.backup) to import the configuration file.
- Click **Export Config**, and then select storage path to export configuration file for backup.

4.5.1.4 Auto Maintenance

You can maintain and operate the system, including reboot, shutdown, SSH enable, auto reboot and default.

Select **Setup > System Config > Auto Maintenance > System Maintenance**. The **System Maintenance** interface is displayed.

Figure 4-47 System maintenance

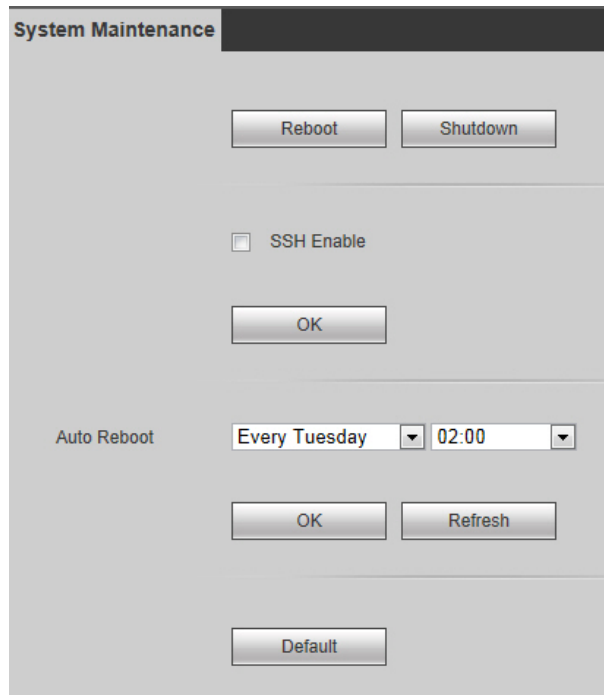

- To manually reboot the system, click **Reboot**, and the system will reboot at once. Click **Shutdown**, and the system will be shut down at once.
- SSH is used to open background debugging port for technicians. Select **SSH Enable**, and click **OK** to enable remote debugging function.
- To reboot the system automatically, select auto reboot day and time, and then click **OK**.
- Click **Default**. The system will be restored to the factory default settings, and your current configurations will be lost. Be cautious.

4.5.1.5 System Upgrade

Store upgrade file in PC that is associated with network video decoder. You can import upgrade file to upgrade the system version.

Step 1 Select **Setup > System Config > System Upgrade**.

The **System Upgrade** interface is displayed.

Figure 4-48 System upgrade

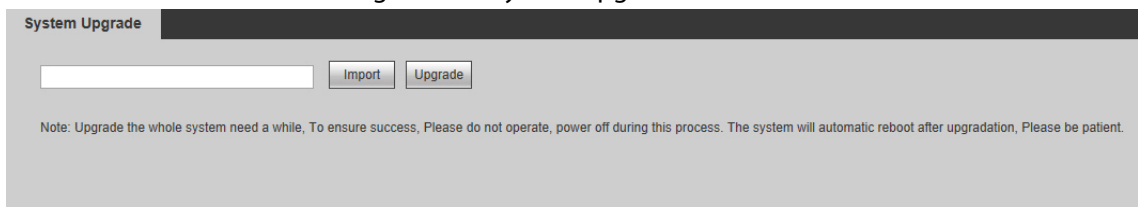

Step 2 Click **Import**, and select the upgrade file.

Step 3 Click **Upgrade**. There is progress bar during upgrade.

After upgrade file is uploaded according to system prompt, the device will reboot. Please keep the power supply on, wait patiently, until the system is automatically rebooted.

4.5.1.6 Picture Management

You can upload a picture to the system, and set the uploaded picture to be screen background.

Step 1 Select **Setup > System Config > Picture Management**.

The **Picture Management** interface is displayed.

Figure 4-49 Picture management

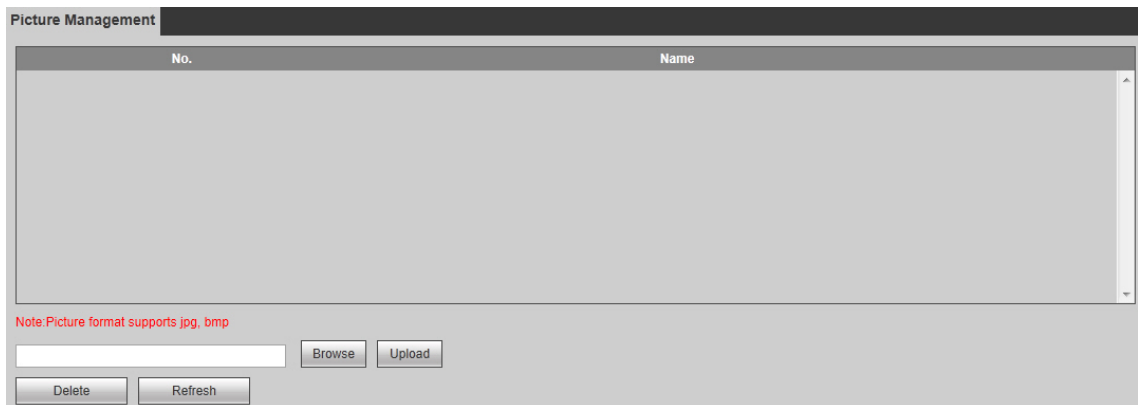

Step 2 Click **Browse** to select a local picture.

Step 3 Click **Upload** to upload local picture.



- Select one picture, and click **Delete** to delete the picture.
- After the background is uploaded successfully, select the background in video wall configuration. See "4.3.4.9.3 Background."

4.5.1.7 Fan Control

You can configure fan temperature control and buzzer alarm.



1-channel 4K high definition (H.265) series, 6-channel 4K high definition (H.265, with 4 input ports) series and 9-channel 4K high definition (h.265, with 4 input ports) series do not support this function.

4.5.1.7.1 Fan Temperature

You can configure different temperature ranges in light of fan speed. The system will trigger different fan speed levels according to the temperature ranges.

Select **Setup > System Config > Fan Control > Fan Temperature**.

Figure 4-50 Fan control–Fan temperature

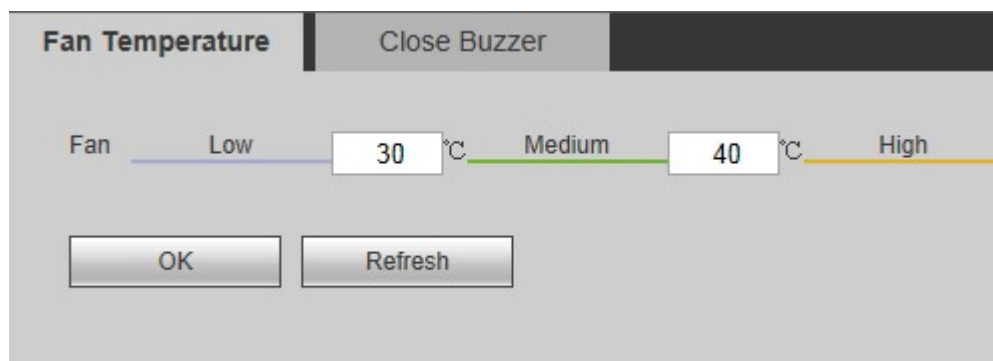

There are three levels: low speed, medium speed, and high speed. Different temperature ranges correspond to different speeds.

4.5.1.7.2 Close Buzzer

You can configure buzzer time. In case of alarm, the system will beep continuously according to the set time. You can close buzzer according to your need.

Step 1 Select **Setup > System Config > Fan Control > Close Buzzer**.

The **Close Buzzer** interface is displayed.

Figure 4-51 Fan control–Close Buzzer

Fan Temperature | **Close Buzzer**

Time Setup (0~600s)

Note: The buzzer will beep continuously if the time is set to 600 and The buzzer Will Shut down if the time is set to 0 .

Step 2 Configure time setup.

Step 3 Click **OK**.



Click **Close Buzzer** to close the buzzer alarm function.

4.5.1.8 Comm Setup

After comm parameters are set, the network video decoder can connect other devices through comm ports, for the purpose of debugging and operation.



1-channel 4K high definition (H.265) series does not support this function.

Step 1 Select **Setup > System Config > Comm Setup**.

The **Comm Setup** interface is displayed.

Figure 4-52 Comm setup

Comm Setup

Slot

Channel

COM Type

Function

Data Bit

Stop Bit

Baud Rate

Parity

Address (0 ~ 255)

Step 2 Configure parameters.

Table 4-10 Comm parameters description

Parameter	Description
Slot	Select the slot you want to configure.
Channel	Select the channel you want to configure.
Com Type	The default is RS-232.
Function	Configure comm function.
Data Bit	Select a data bit. The options include 5, 6, 7 and 8.
Stop Bit	Select stop bit of comm, including 1 and 2.
Baud Rate	Configure Baud rate of comm. It shall be consistent with the device that will be connected.
Parity	Select a parity mode from N/A, Odd, Even, Flag Parity and Empty Parity.
Address	Configure comm address from 0 to 255.

Step 3 Click **Save**.

4.5.1.9 Security Management

Configure system service, enable or disable HTTPS function according to your need, to strengthen system security management.

4.5.1.9.1 Firewall

Select the firewall that you want to enable.

Step 1 Select **Setup > System Config > Security Management > Firewall**.

The **Firewall** interface is displayed.

Figure 4-53 Firewall

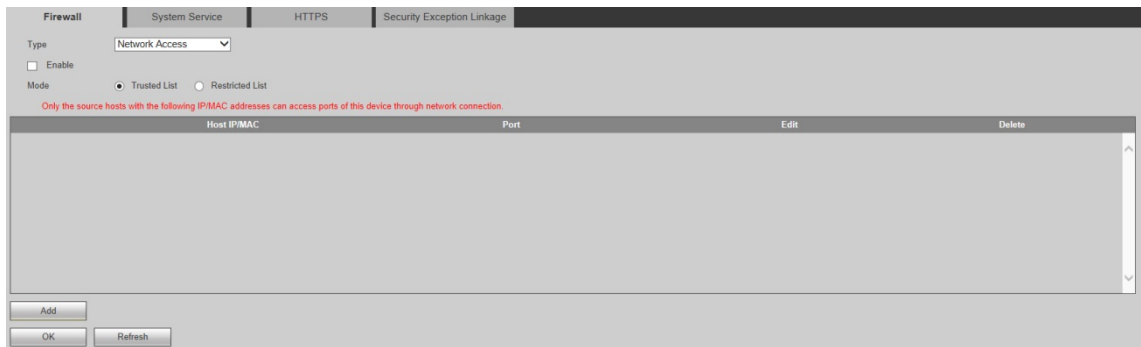

Step 2 Select **Type**. Three types are available at present:

- Network Access: Configure the firewall by adding trusted list and restricted list.
- Forbid Ping: After it is enabled, all network access will be forbidden.
- Semi Join: After it is enabled, network connection probability is 50%.

Step 3 Select **Enable**.

Step 4 (Optional) Select **Mode**, and configure trusted list and restricted list.

- Trusted list: Only source hosts with the configured IP/MAC address can access the device port through network connection.
- Restricted list: Source hosts with the configured IP/MAC address are forbidden from accessing the device port through network connection.



- It can be configured only in **Network Access** type.
 - Trusted list and restricted list can be configured in the same way. Take trusted list for example.
- 1) Select **Trusted List** in **Mode**.
 - 2) Click **Add**.
The **Add** interface is displayed.

Figure 4-54 Add

The 'Add' dialog box is shown with the following fields:

- Type: IP (dropdown), IPv4 (dropdown)
- IP: [. . .]
- Start Port: 1 (range: 1~65535)
- End Port: 65535 (range: 1~65535)

Buttons: OK, Cancel

- 3) Select **Type**, and then configure **IP**, **Start Port** and **End Port**.
Type supports **IP**, **IP Segment** and **MAC Address**. Configure parameters according to actual situation.
- 4) Click **OK**.
The added device IP/MAC is displayed.

Figure 4-55 Added

Host IP/MAC	Port	Edit	Delete
1			



- Click to edit device information.
- Click to delete the device.

Step 5 Click **OK**.

The system prompts "Saved successfully".



Click **Refresh**. The system prompts that "Operation is successful", and the interface is refreshed.

4.5.1.9.2 System Service

Select the system service you want to enable.

Step 1 Select **Setup > System Config > Security Management > System Service**.

The **System Service** interface is displayed.

Figure 4-56 System service

Step 2 Enable system service.

Table 4-11 System service parameters description

Parameter	Description
CGI	Common Gateway Interface (CGI) is an interface between external application programs and web server.
Audio/Video Transmission Encryption	Encrypt the video during transmission. Audio is not currently supported.
RTSP TLS Service	Encrypt before requesting video service from video server.

Step 3 Click **OK**.

4.5.1.9.3 HTTPS

Through creating server certificate or downloading root certificate on the HTTPS interface, you can log in to the PC by HTTPS, to ensure the security of communication data, and guard the users' information and device security with stable technology measure.

Step 1 Select **Setup > System Config > Security Management > HTTPS**.

The **HTTPS** interface is displayed.

Figure 4-57 HTTPS

Step 2 Select the **Enable HTTPSs** check box.

Step 3 Configure HTTPs port.

Step 4 Click **OK**.



- For the first time to use this function or after changing IP address of the device, you need to create server certificate again.
- For the first time to use HTTPS after changing the PC, you need to download root certificate again.
- If a local signature certificate already exists, click **Install Signature Certificate**.
- HTTPS enable status will take effect after reboot.

Figure 4-58 Create server certificate

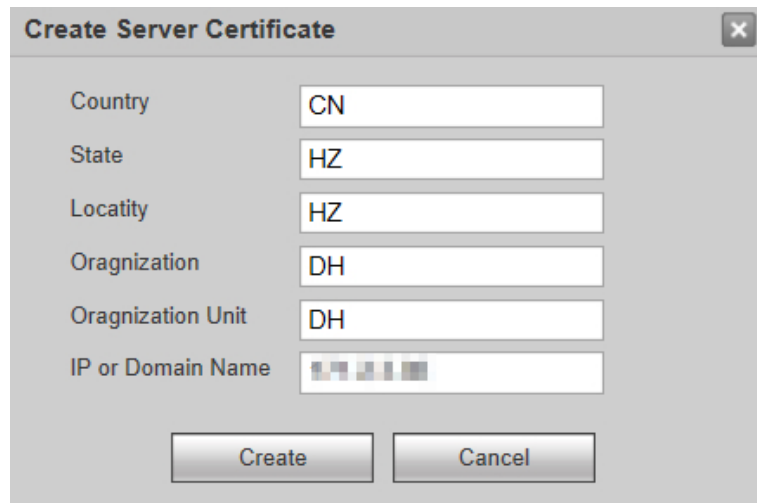
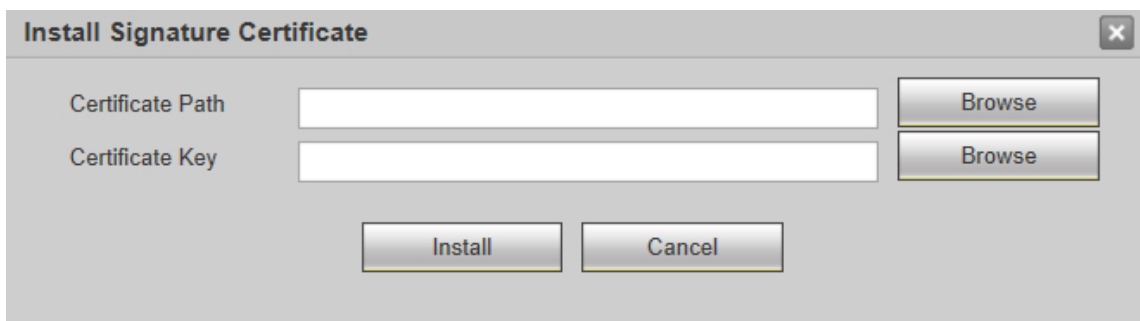

Figure 4-59 Install signature certificate



4.5.1.9.4 Security Exception Linkage

Configure alarm linkage mode.

- Step 1** Select **Setup > System Config > Security Management > Security Exception Linkage**.
The **Security Exception Linkage** interface is displayed.

Figure 4-60 Security exception linkage

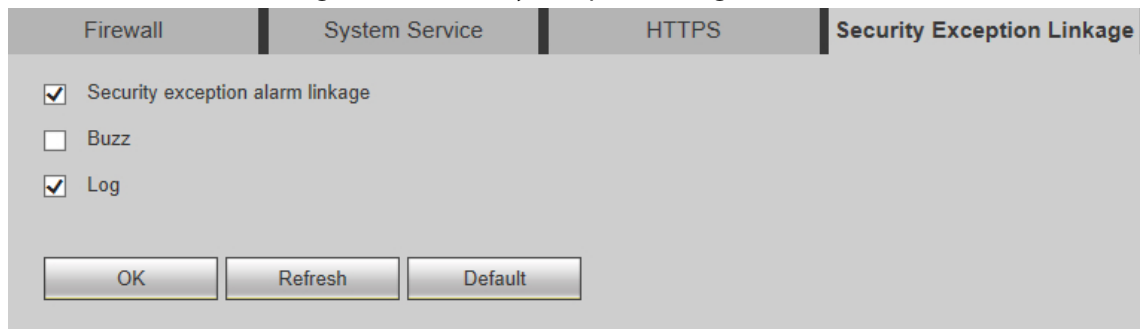

- Step 2** Select **Security exception alarm linkage** to enable it.

- Step 3** Select alarm linkage mode, including **Buzz** and **Log**.



Both alarm linkage modes can be selected at the same time.

- Step 4** Click **OK** to complete configuration.

4.5.1.10 Storage Path

Select the storage path for snapshots and records.

Step 1 Select **Setup > System Config > Storage Path**.

The **Storage Path** interface is displayed.

Figure 4-61 Storage path

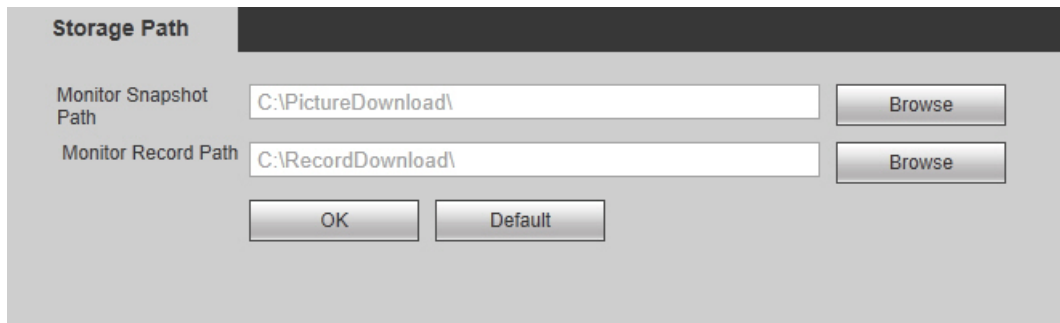

Step 2 Click **Browse** to select the storage path for snapshots and records respectively.

Step 3 Click **OK**.



Click **Default** to restore default path. Default storage path of monitor snapshot and monitor record is C:\PictureDownload and C:\RecordDownload respectively.

4.5.2 Network

4.5.2.1 TCP/IP

Set device IP address, DNS server information and other information according to network planning.



- Before configuring network parameters, make sure that the device is connected to the network properly.
- If there is no routing device in the network, distribute IP address in the same network segment.
- If there is a routing device in the network, you only need to configure gateway and subnet mask.

Step 1 Select **Setup > Network > TCP/IP**.

The **TCP/IP** interface is displayed.

Figure 4-62 TCP/IP

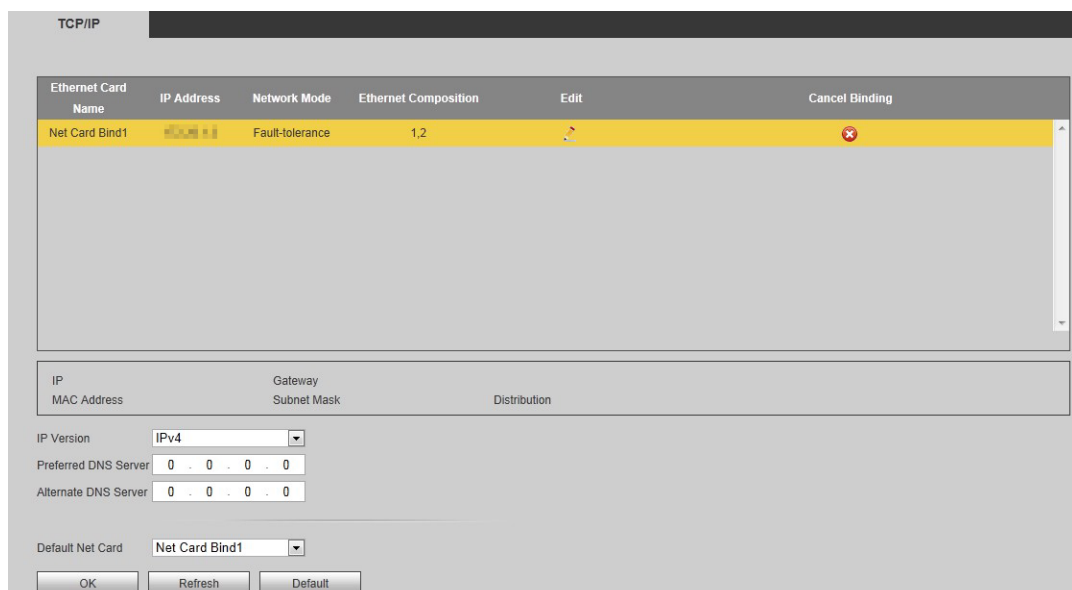

Step 2 Set TCP/IP parameters.

Table 4-12 TCP/IP parameters description

Parameter	Description
IP Version	Select IP version . It is IPv4 by default.
Preferred DNS Server	Fill in the configured IP address of DNS server.
Alternate DNS Server	Fill in the configured IP address of alternate DNS server.
Default Net Card	Select default net card.

Step 3 Click  to edit Ethernet card information.

Figure 4-63 Edit



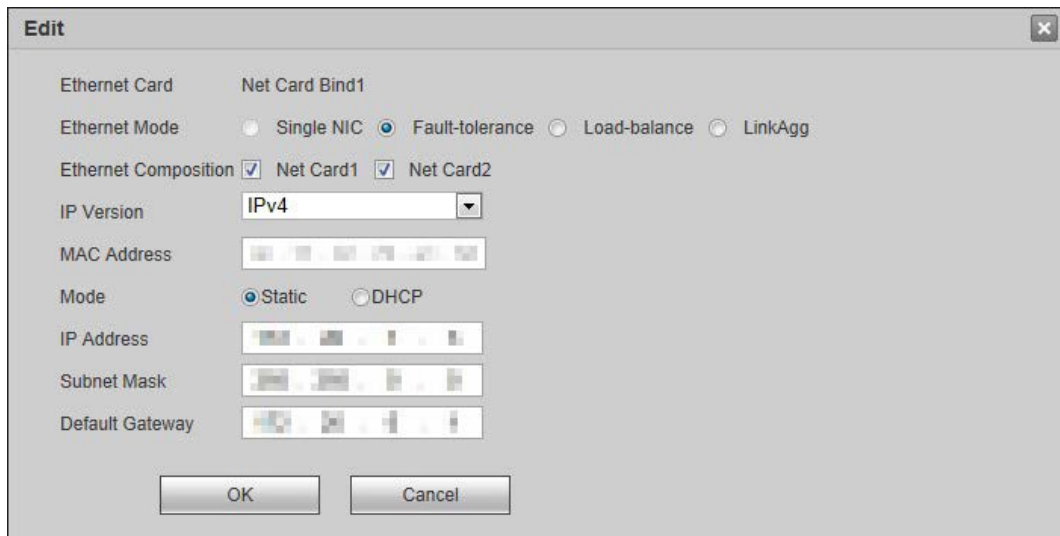

The screenshot shows a dialog box titled "Edit" with a close button in the top right corner. The dialog is divided into two main sections: "Ethernet Card" and "Net Card Bind1".

- Ethernet Card:**
 - Ethernet Mode:** Radio buttons for "Single NIC", "Fault-tolerance" (selected), "Load-balance", and "LinkAgg".
 - Ethernet Composition:** Checkboxes for "Net Card1" and "Net Card2", both of which are checked.
 - IP Version:** A dropdown menu currently set to "IPv4".
 - MAC Address:** A text field with a grid of input boxes for each octet.
 - Mode:** Radio buttons for "Static" (selected) and "DHCP".
 - IP Address:** A text field with a grid of input boxes for each octet.
 - Subnet Mask:** A text field with a grid of input boxes for each octet.
 - Default Gateway:** A text field with a grid of input boxes for each octet.
- Net Card Bind1:** This section is currently empty.

At the bottom of the dialog, there are two buttons: "OK" and "Cancel".

Table 4-13 Ethernet card parameters description

Parameter	Description
Ethernet Mode	<p>The default setting is single NIC.</p> <ul style="list-style-type: none"> ● Single NIC: Two net cards are used independently. Request HTTP, RTSP and other services of the device through net card 1 or net card 2. You need to configure one default net card (net card 1 by default), to request network services launched by the device, including DHCP, Email and FTP. During network status detection, the network is deemed to be disconnected if one net card is disconnected. ● Fault tolerance: All Ethernet cards use one IP address, and only one Ethernet card works under normal conditions. If working Ethernet card breaks down, the other Ethernet card is enabled automatically to ensure smooth network. It is deemed that the network is disconnected only when both Ethernet cards are disconnected during network status check. Both Ethernet cards need to be in the same LAN. ● Load balance: All Ethernet cards use one IP address, and all of them work together to bear network load; the bound network throughputs are basically the same. If one Ethernet card breaks down, the other Ethernet card works normally. It is deemed that the network is disconnected only when both Ethernet cards are disconnected during network status check. Both Ethernet cards need to be in the same LAN. ● Link aggregation: The system uses NIC bonding to realize communication function. All bonded NICs are working together and bearing the network load. The system allocates the corresponding ports to the specified switches according to the port load setting. Once one port link malfunctions, the system stops sending out data from current port. The system can calculate the new load and specify the new port(s) to send out data. The system calculates again to specify the port(s) once the malfunction port becomes available. <p> Single NIC device does not support Ethernet mode selection. The actual device shall prevail.</p>
Ethernet Composition	Select net card according to your need.
IP Version	It is IPv4 by default.
MAC Address	Displays the MAC address of the Device.

Parameter	Description
Mode	<ul style="list-style-type: none"> ● Static Manually enter the IP address, subnet mask and gateway. ● DHCP Select the DHCP box, the system automatically obtains an IP address. When the DHCP function is enabled, the IP address, subnet mask and default gateway cannot be set manually. <ul style="list-style-type: none"> ◇ If DHCP is effective, the obtained information will be displayed in the IP Address box, Subnet Mask box and Default Gateway box. If DHCP is not effective, they all display 0. ◇ To view manually set IP when DHCP is not effective, you shall disable DHCP first, and then the device will display IP info that is not obtained through DHCP. If DHCP is effective, if DHCP is disabled, static IP information will restore default settings. You need to configure IP again.
IP Address	Enter numbers to change the IP address, and then configure its Subnet Mask and Default Gateway .
Subnet Mask	
Default Gateway	
 IP address and default gateway must be in the same network segment.	

Step 4 Click **OK** to complete modification of net card information.

Step 5 Click **OK**.

4.5.2.2 Port

Set max connection and port number to visit network video decoder through client (including web client and PC client).

Step 1 Select **Setup > Network > Port > Connection Setup**.

The **Connection Setup** interface is displayed.

Figure 4-64 Connection setup

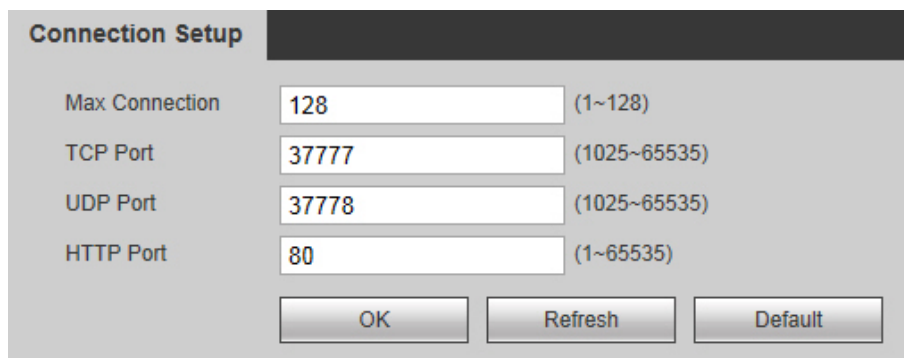

Connection Setup	
Max Connection	128 (1~128)
TCP Port	37777 (1025~65535)
UDP Port	37778 (1025~65535)
HTTP Port	80 (1~65535)
<input type="button" value="OK"/> <input type="button" value="Refresh"/> <input type="button" value="Default"/>	

Step 2 Configure max connection and port number.

Table 4-14 Port parameters description

Parameter	Description
Max Connection	The allowable maximum number of clients accessing the Device at the same time, such as web, platform, and mobile phone. The default value is 128.
TCP Port	TCP service port. The default setting is 37777. You can configure this parameter.

Parameter	Description
UDP Port	User Datagram Protocol port. The default value setting is 37778. You can enter the value.
HTTP Port	Hyper Text Transfer Protocol port. The default setting is 80. You can enter the value, and in this case, please add the modified port number after the address when logging the Device on the browser.

Step 3 Click **OK**.



Except **Max Connection**, modifications of other parameters will take effect after reboot.

4.5.2.3 Sync IP

Sync IP adds IP of a device with timing function, to synchronize system time, and ensure the system time is correct.

Step 1 Select **Setup > Network > Sync IP**.

The **Sync IP** interface is displayed.

Figure 4-65 Sync IP



Step 2 Enter IP address, and then click **Add**.

Step 3 Click **OK**.

4.5.3 Event Management

Manage abnormal events. The system executes alarm linkage actions according to settings.

4.5.3.1 Alarm Setup

You can configure local alarm and alarm output.

4.5.3.1.1 Local Alarm

Configure local alarm. When an abnormal event occurs, the system executes alarm linkage actions.

Step 1 Select **Setup > Event Management > Alarm Setup > Local Alarm**.

The **Local Alarm** interface is displayed.

Figure 4-66 Local alarm

Local Alarm		Alarm Output	
Alarm Event	Local Alarm	Slot	0
Channel	1	Channel Name	Slot00_01
Type	NO	<input type="checkbox"/> Enable	
period	<input type="button" value="Setup"/>	Alarm Output Delay	10 Second(10~300)
<input type="checkbox"/> Alarm Output	<input type="button" value="Setup"/>	Anti-dither	5 Second(0~15)
<input type="checkbox"/> Buzzer	<input checked="" type="checkbox"/> Log		
<input type="button" value="Save"/>		<input type="button" value="Refresh"/>	

Step 2 Configure the parameters.

Table 4-15 Alarm parameters description

Parameter	Description
Alarm Event	Select alarm event. It is Local Alarm by default.
Slot	Select the slot of local alarm.
Channel	Select the alarm channel.
Channel Name	Enter the alarm channel name.
Type	Select external alarm device type. Both NO and NC are supported. Select the check box to enable the function.
Period	Configure alarm period. Alarm is produced only within the configured period. Click Setup to configure alarm period in the following steps: <ol style="list-style-type: none"> Select week. Configure the time period. A total of 6 periods can be configured. <ul style="list-style-type: none"> Click Default Time, and all periods will be default period, 00:00:00–23:59:59. Click Current Time, and the period will be the last saved time. Select the day(s) in Apply to zone, so the configured periods will be applied to the day(s). Click OK.
Alarm Output	Connect alarm output port with alarm devices (such as light and siren etc.). In case of alarm, the system will send alarm information to alarm devices. Click Setup to select slot.
Alarm Output Delay	After the alarm is stopped, the alarm output is delayed for some time, ranging from 10 seconds through 300 seconds.
Anti-dither	The system records only one alarm input event during the configured period.
Buzzer	The system activates a buzzer alarm when an alarm event occurs.
Log	The log records alarm information when an alarm event occurs.

Step 3 Click **Save**.

4.5.3.1.2 Alarm Output

When an abnormal event occurs, alarm output channel produces alarm signal. Alarm device connected with alarm output port will execute alarm linkage actions.

Step 1 Select **Setup > Event Management > Alarm Setup > Alarm Output**.

The **Alarm Output** interface is displayed.

Figure 4-67 Alarm output



Step 2 Select alarm output slot and channel.

Step 3 Click **Save**.

4.5.3.2 Abnormal

Set alarm linkage actions when an abnormal event occurs. The system executes alarm linkage actions.

Step 1 Select **Setup > Event Management > Abnormal**.

The **Abnormal** interface is displayed. Select abnormal type.

Figure 4-68 Network offline

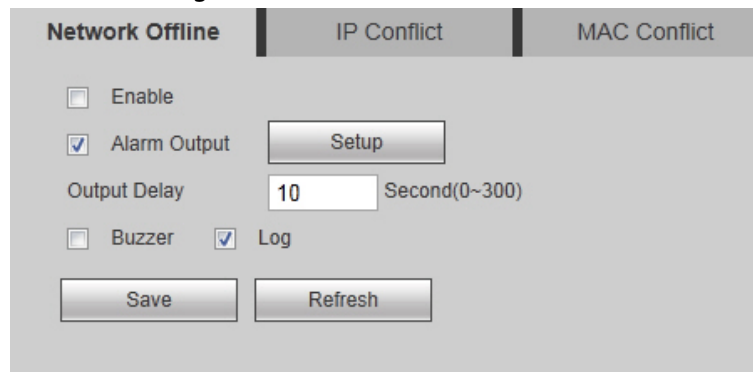

Figure 4-69 IP conflict



Figure 4-70 MAC conflict

Step 2 Select **Enable** to enable the alarm function.

Step 3 Configure the parameters.

Table 4-16 Abnormal parameters description

Parameter	Description
Alarm Output	Connect alarm output port with alarm devices (such as light and siren etc.). In case of alarm, the system will send alarm information to alarm devices. Click Setup to select slot.
Output Delay	After the alarm is stopped, the alarm output is delayed for some time, ranging from 0 seconds through 300 seconds.
Buzzer	The system activates a buzzer alarm when an alarm event occurs.
Log	The log records alarm information when an alarm event occurs.

Step 4 Click **Save**.

4.5.4 Signal Management

You can manage network signal, local signal and signal group.

4.5.4.1 Network Signal

You can add devices in the network, preview and display network signal on the video wall, and also control the remote device.



The device shall have a decoding card, so network signal can be decoded and displayed on the video wall.

Select **Setup > Signal Management > Network Signal**. The **Network Signal** interface is displayed.

Figure 4-71 Network signal

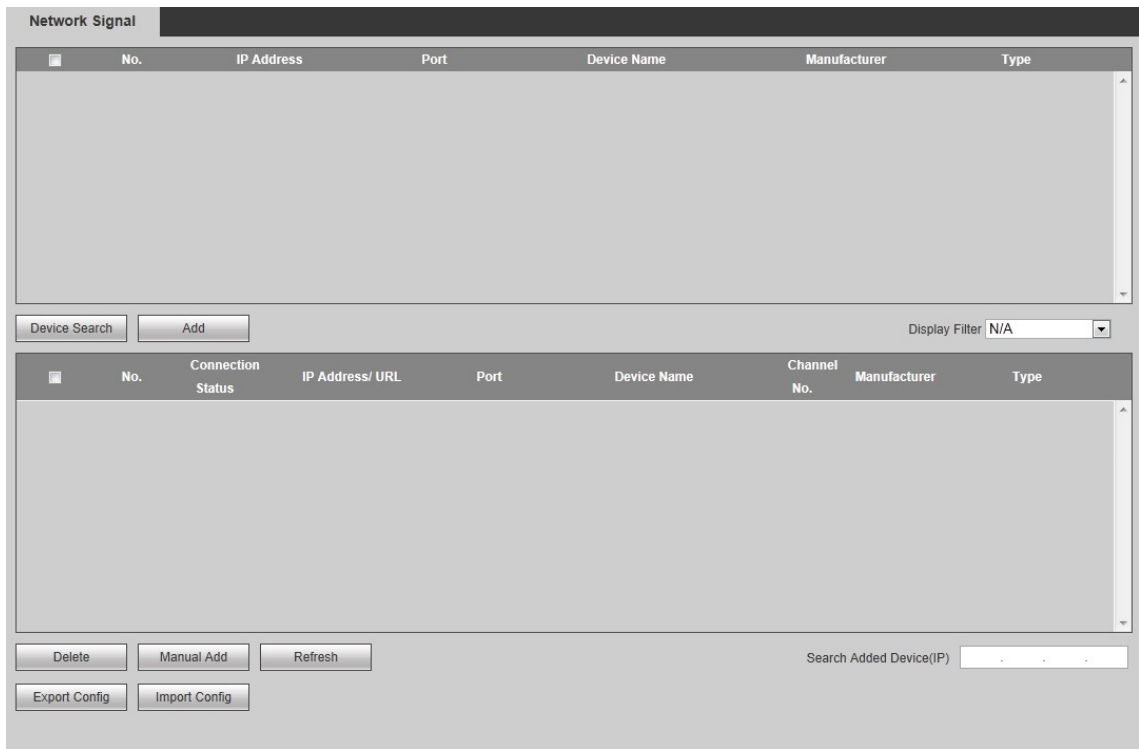

Searching and Adding

Step 1 Click **Device Search**.

The system starts to search all network signals in the LAN.

Figure 4-72 Searching signal

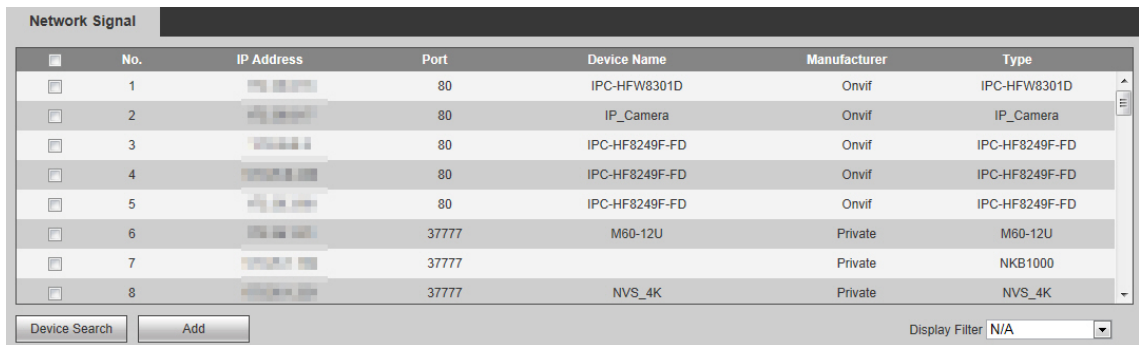

Filter device type in **Display Filter**. For example, select IPC, and all IPC devices will be displayed here.

Step 2 Select the check box corresponding to the network signal, and click **Add**.

This network signal is displayed in the list, and the system displays **Saved successfully..**

Figure 4-73 Adding signal

Network Signal

No.	IP Address	Port	Device Name	Manufacturer	Type
1	192.168.1.1	80	IPC-HFW8301D	Onvif	IPC-HFW8301D
2	192.168.1.2	80	IP_Camera	Onvif	IP_Camera
3	192.168.1.3	80	IPC-HF8249F-FD	Onvif	IPC-HF8249F-FD
4	192.168.1.4	80	IPC-HF8249F-FD	Onvif	IPC-HF8249F-FD
5	192.168.1.5	80	IPC-HF8249F-FD	Onvif	IPC-HF8249F-FD
6	192.168.1.6	37777	M60-12U	Private	M60-12U
7	192.168.1.7	37777	NKB1000	Private	NKB1000
8	192.168.1.8	37777	NVS_4K	Private	NVS_4K

Device Search: Add Display Filter: N/A

No.	Connection Status	IP Address/ URL	Port	Device Name	Channel No.	Manufacturer	Type
1	Failed	192.168.1.1	80	IPC-HF8249F-FD	1	Onvif	IPC-HF8249F-FD
2	Successful	192.168.1.2	80	IPC-HFW8301D	1	Onvif	IPC-HFW8301D
3	Failed	192.168.1.3	80	IPC-HF8249F-FD	1	Onvif	IPC-HF8249F-FD

Delete Manual Add Refresh Search Added Device(IP)

Export Config Import Config

✔ Saved successfully!

- If the device is under normal use, **Connection Status** will change from **Failed** to **Successful** after several seconds. The system will display **Saved successfully** again.
- If **Connection Status** remains **Failed**, the device might not be started, or a black list has been configured, or it is not included in a white list.



Enter IP address in **Search Added Device (IP)** search box, and this device information will be marked yellow in the list.

Manual Add

- Step 1** Click **Manual Add**.
The **Manual Add** interface is displayed.

Figure 4-74 Manual add

Step 2 Configure the parameters.

Table 4-17 Manual add parameters description

Parameter	Description
Device Name	It is to fill in device name.
Manufacturer	Select device manufacturer.
Protocol	It is TCP by default.
IP Address	Configure the IP address of device to be added.
Port	Configure port number of device to be added. The port number is 37777 by default.
Username	Configure the username to log in the device to be added.
Password	Configure the password to log in the device to be added.
Channel No.	Number of connected channels.

Step 3 Click **OK**.

This network signal is displayed in the list, and the system displays **Saved successfully**.

Import and Export Config

Import and export configurations to add network signals in batches.



Enable HTTPS before using **Import Config** and **Export Config** functions. See "4.5.2.2 Port".

Step 1 Import or export configurations.

- Click **Import Config**, to import the preset devices information into the system.
- Click **Export Config**, to export configuration file and save it in local device for backup.

Step 2 Click **Import Config** or **Export Config** in HTTP environment.

A dialog box is displayed.

Figure 4-75 Dialog box

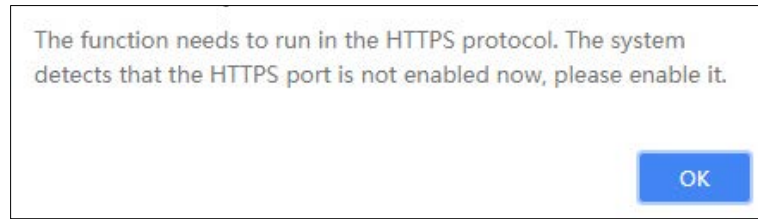



- Step 3** Click **OK**. The system jumps to HTTPS environment.
You need to login again, and then click **Import Config** or **Export Config**.

Deleting Network Signal

Select a network signal from the added signal list, and click **Delete** to delete the network signal.

Sorting

Click each attribute field, and  will appear on the right of the field, meaning the network signal is arranged in descending order. Click it again, and the icon turns into , meaning the network signal is arranged in ascending order.

4.5.4.2 Local Signal



1-channel 4K high definition (H.265) series does not support this function.

You can configure input title and control ID of each channel on the board card. Control ID can correspond to the binding source (such as keyboard), so the binding source can be displayed on the TV wall.

- Step 1** Select **Setup > Signal Management > Local Signal > Input Title**.
The **Input Title** interface is displayed.

Figure 4-76 Input title

Card	Start ControlID	Setup	
Slot1			
Channel1: HDMI IN01	ControlID: 1	Channel2: HDMI IN02	ControlID: 2
Channel3: DVI IN01	ControlID: 3	Channel4: DVI IN02	ControlID: 4



The interface of 6-channel 4K high definition (H.265, with 4 input ports) series and 9-channel 4K high definition (H.265, with 4 input ports) series is displayed above. For other models, the actual interface shall prevail.

- Step 2** Select the card, and configure channel name and control ID for each channel.



Enter **Start Control ID** and click **Setup**, so control ID of channels will start from the **Start Control ID**.

Step 3 Click **OK**.

4.5.4.3 Signal Group

You can customize signal group. **Signal Group** tab displays added group and signal source. You can drag signal group to the window for loop play of signals in the group.

Step 1 Select **Setup > Signal Management > Signal Group**.

The **Signal Group** interface is displayed.

Figure 4-77 Signal group

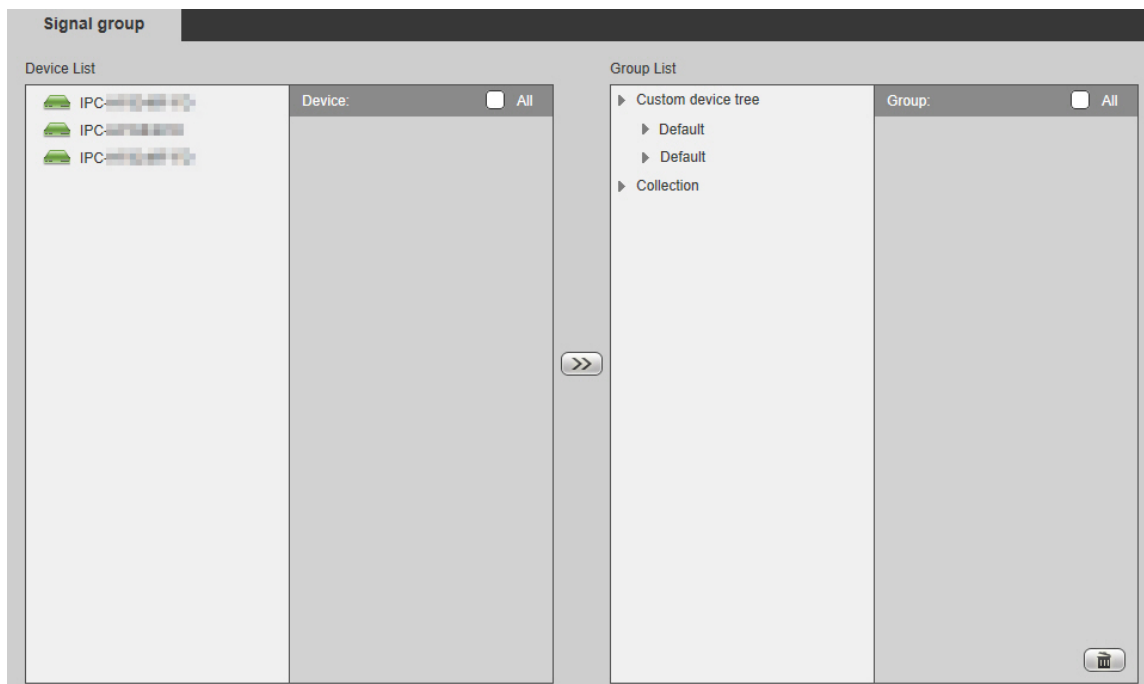

Step 2 Create a group.

- 1) Move your mouse pointer to **Custom device tree** or **Collection** in **Group list**, and then click **+**.

Figure 4-78 Create a group

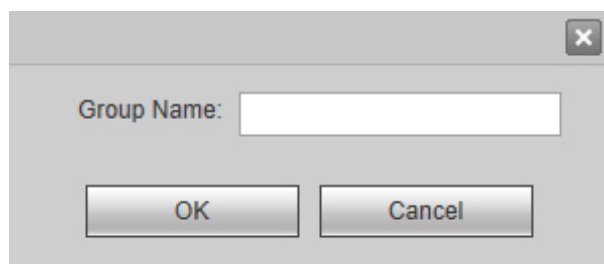

- 2) Enter group name, and then click **OK**.
A group has been created.

Figure 4-79 Creation is completed

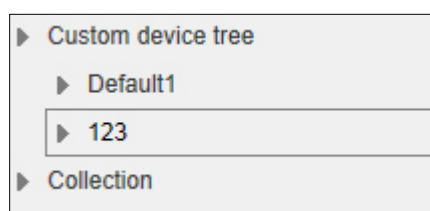

Move your mouse pointer to group name. Icons are displayed.



Figure 4-80 Editing icons



- Click  to create a sub-group under this group.



Sub-group cannot be created under **Collection** group.

- Click  to rename this group.
- Click  to delete this group.

Step 3 Select signal.

- 1) Select a device from **Device List**.

Device name list displays all signals under this device.

Figure 4-81 Select device

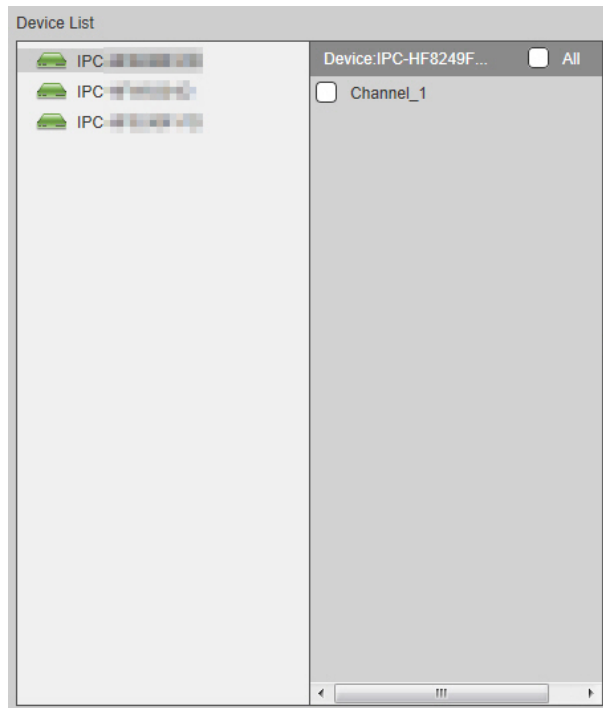

- 2) Select one signal or multiple signals.



Select **All** to select all the signals.

Step 4 Select a group.

Step 5 Click .

Signals have been divided into groups.

Figure 4-82 Grouping is completed

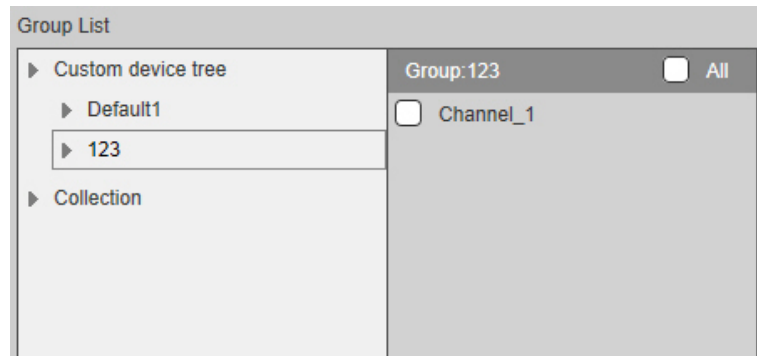

- Select a signal from a group, and click  to delete the signal.
- Select **All** to select all the signals.

4.5.5 Display Management

You can configure video wall, manage screen, configure output display and output name.

4.5.5.1 Video Wall Setup



The interface is different depending on device model. The actual interface shall prevail.

You can configure video walls according to actual quantity and splitting of screens, so signals can be displayed on video walls.

Select **Setup > Display Management > Video Wall Setup**. The **Video Wall Setup** interface is displayed.

Figure 4-83 Video wall setup

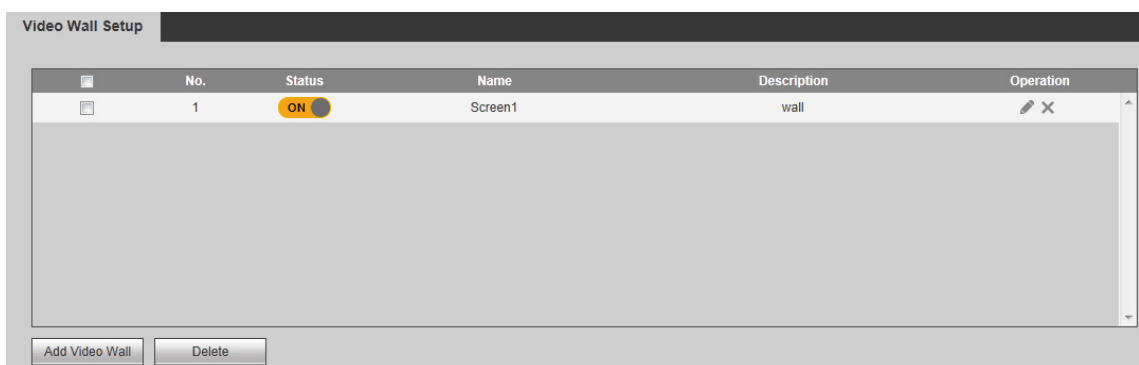

4.5.5.1.1 Adding Video Wall

Step 1 Click **Add Video Wall**.

The **Video Wall Layout Setup** interface is displayed.

Figure 4-84 Video wall layout setup

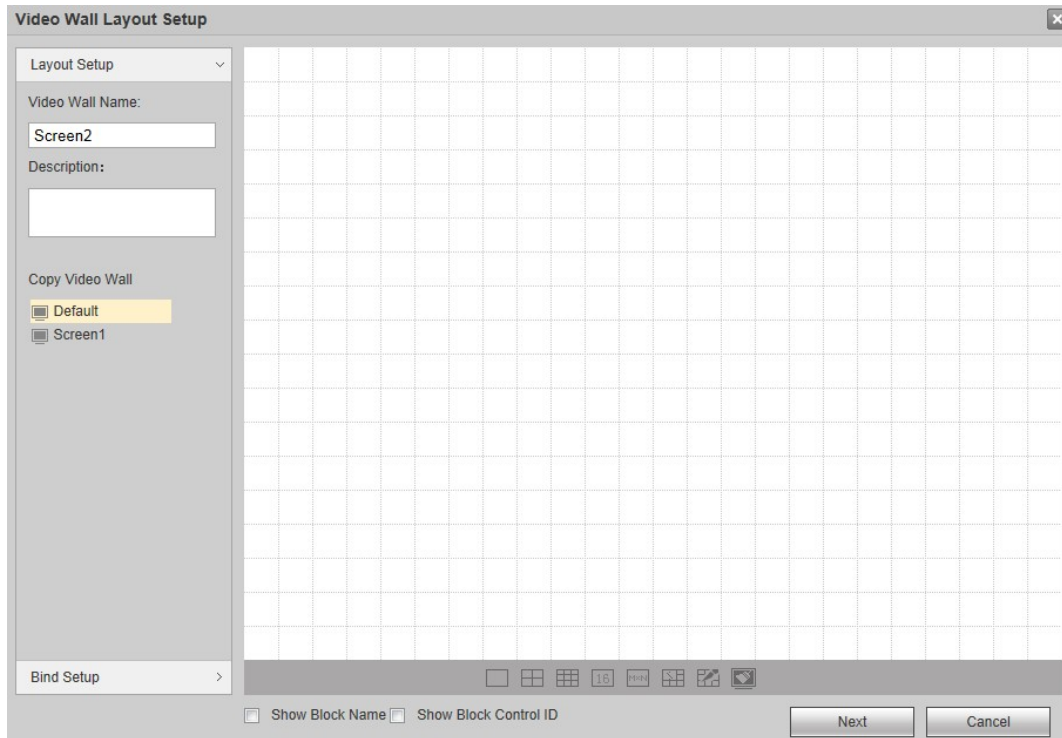

Step 2 Configure the layout.

- 1) Customize **Video Wall Name** and **Description**.
- 2) Click icons at the bottom of the interface, to add single screen and split screen quickly.



Press and hold on left mouse button, you can drag the screen to anywhere you want.

Figure 4-85 Add screen

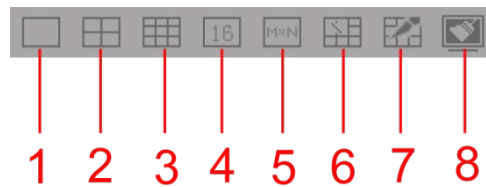

Table 4-18 Parameters description

No.	Name	Description
1	Single Screen	Click to add single screen.
2	4-split Screen	Click to add a 4-split screen.
3	9-split Screen	Click to add a 9-split screen.
4	16-split Screen	Click to add a 16-split screen.
5	Custom	Click this icon, enter row and column number in the pop-up User Custom interface, and you can add a custom screen.
6	Splicing	Select separate screens, and click this icon to splice them.  <ul style="list-style-type: none"> ● Splicing screen cannot be selected. ● Single screens shall be connected horizontally or vertically.
7	Cancel Splicing	Select splicing screens, and click this icon to cancel their splicing.
8	Clear Screen	Clear all screens on the video wall.

Figure 4-86 Add screen



You can select existing video wall from **Copy Video Wall** zone on the left of the interface, and then layout of video wall is displayed on the right of the interface. You can modify the layout directly.

Figure 4-87 Copy video wall

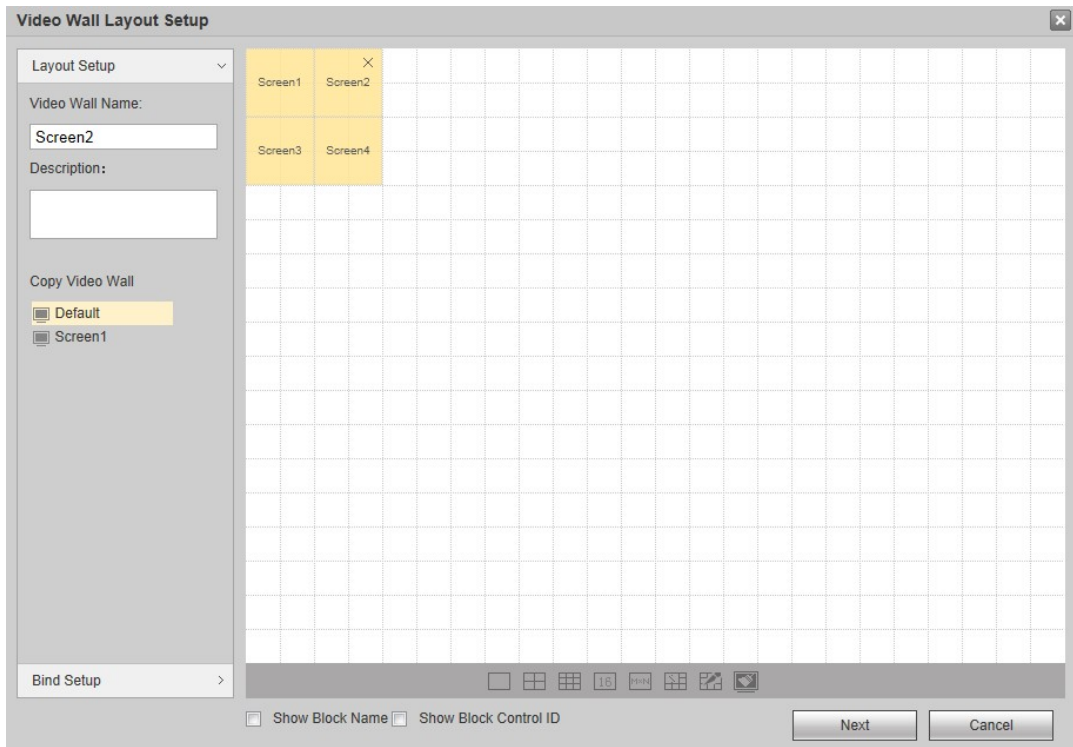
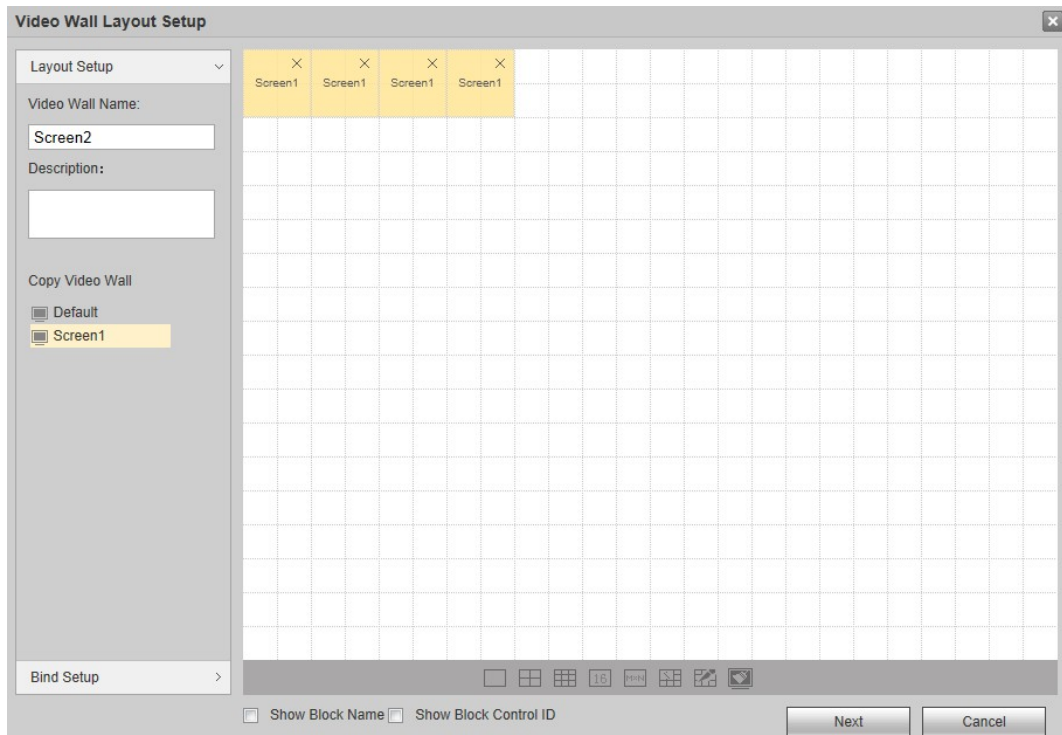

Step 3 (Optional) Select **Show Block Name**. Every splicing screen will show a block name, such as Splicing Video Wall 1.



- For single screen, it still shows Screen 1, Screen 2 and so on.
- Double-click to modify block name.

Figure 4-88 Show block name



Select **Show Block Control ID**, and control ID of every block will be shown.



Show Block Name and **Show Block Control ID** cannot be selected at the same time.

Step 4 Click Bind Setup tab or Next.

The slot information is displayed.

Figure 4-89 Slot information

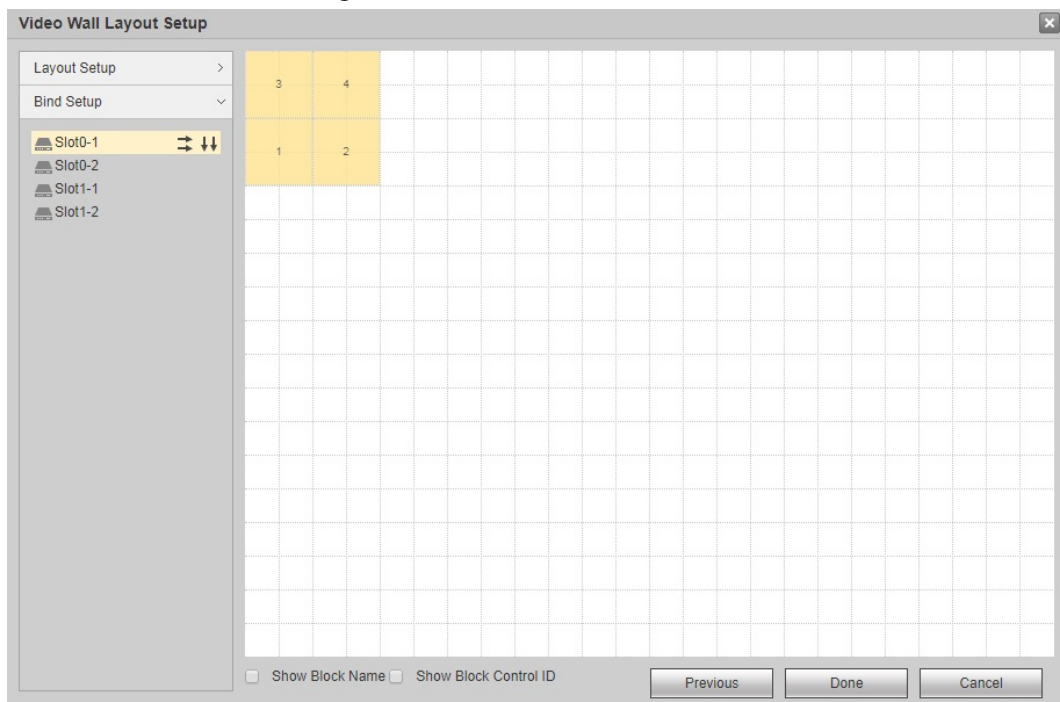

Step 5 Select one slot, press and hold on left mouse button to drag the slot onto the screen, and bind the slot channel with screen.





- All screens on the video wall shall be bound with slot channel; otherwise, when you click **Done**, the system will prompt you that "**There is sub screen without bound decoding channel in screen!**"
- Slot cannot be bound repeatedly. In case of error, drag a correct slot channel onto the screen, to cover it directly.
- Click  to automatically bind slot with single screen horizontally.
- Click  to automatically bind slot with single screen vertically.

Figure 4-90 Slot binding



Step 6 Double-click a new video wall block.
The **Block Setup** interface is displayed.

Figure 4-91 Block setup

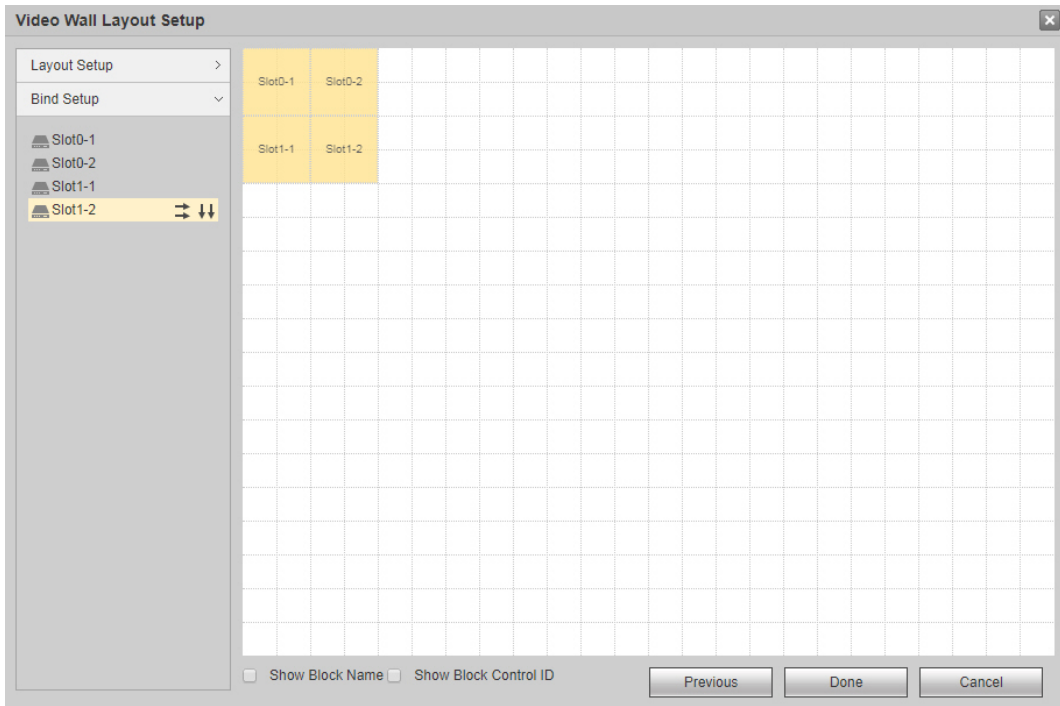
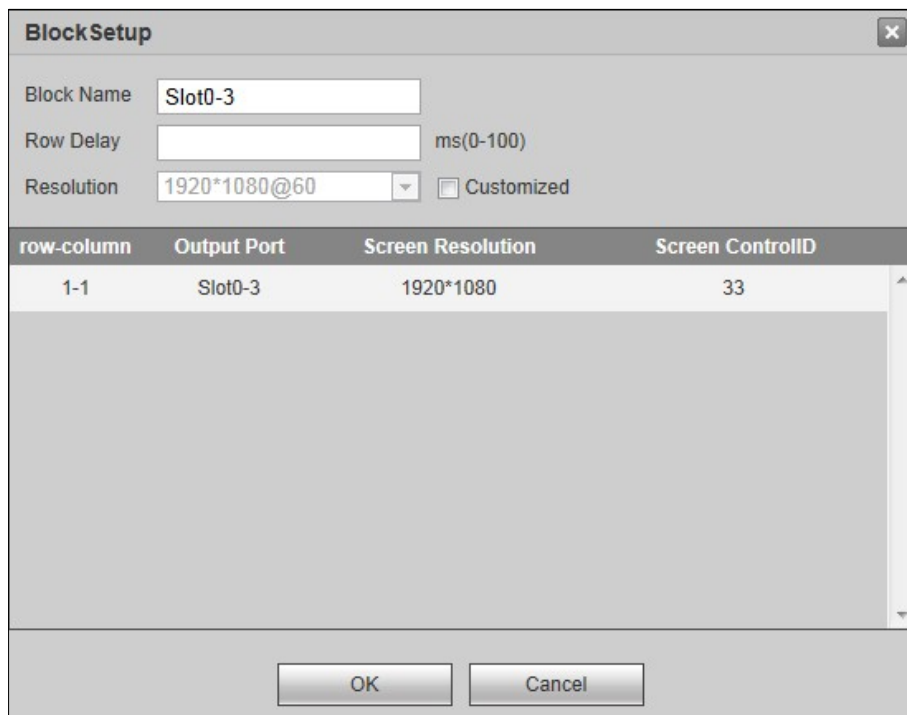

Step 7 Set parameters.

Table 4-19 Block setup parameters description

Parameter	Description
Name	Configure block name.
Row Delay	Configure row delay ranging from 0ms to 100ms.
Resolution	Select Customized to configure resolution of output screen corresponding to each slot.

Step 8 Click **OK**.

Step 9 Click **Done**.

The system exits **Video Wall Layout Setup** interface. The new video wall is displayed in video wall list.

Figure 4-92 Adding is completed

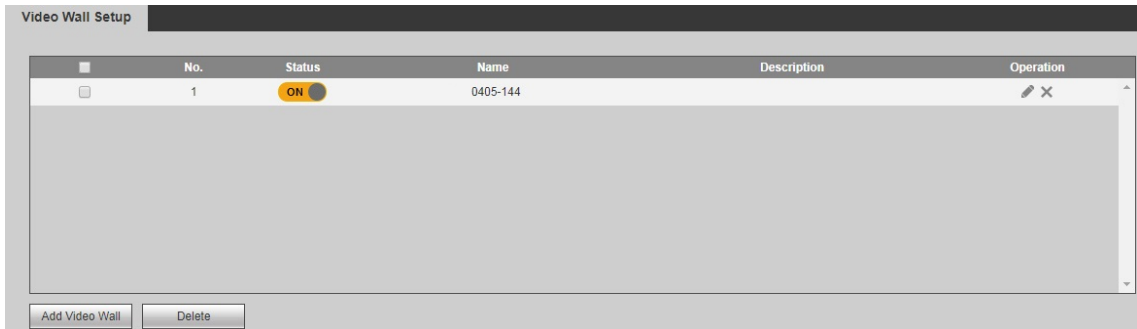

4.5.5.1.2 Modifying Video Wall

Click , and modify video wall information in the pop-up **Video Wall Layout Setup** interface. See "4.5.5.1.1 Adding Video Wall".

4.5.5.1.3 Deleting Video Wall

Tick the video wall check box, click **Delete** or , to delete the selected video wall after confirmation.

4.5.5.2 Screen Management

You can configure screen parameters, to turn on and turn off the screen.

4.5.5.2.1 Screen Setup

Configure manufacturer, serial port and com address of every output screen, to realize communications between screen and device. Com address shall be the same with DIP address of video wall.

Step 1 Select **Setup > Display Management > Screen Management > Screen Setup**.

The **Screen Setup** interface is displayed.



The interface is different depending on device model. The actual interface shall prevail.

Figure 4-93 Screen setup

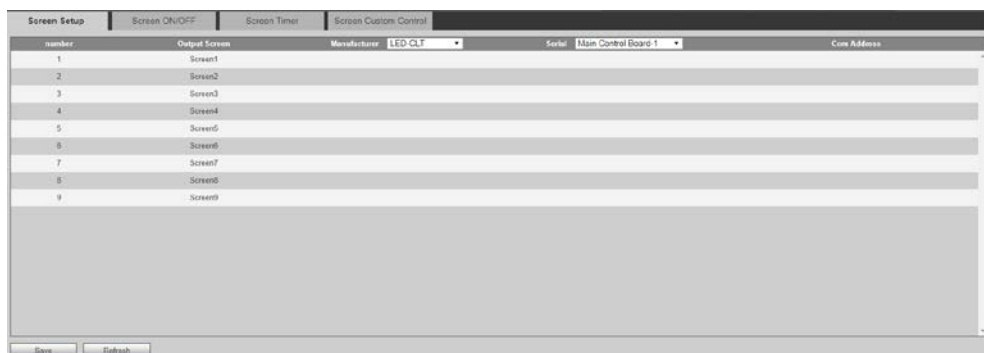

Step 2 Click drop-down list or text box to configure manufacturer, serial port and com address.



- They shall be the same with actual manufacturer, serial port and com address (DIP address) of video wall.
- Click drop-down list at the top, to configure manufacturer and serial port together.

Step 3 Click **Save**.

4.5.5.2.2 Screen ON/OFF

According to preset interval and time, the device sends ON/OFF commands to all screens continuously, and ensures that each screen receives commands and turns ON/OFF.

Step 1 Select **Setup > Display Management > Screen Management > Screen ON/OFF**.

The **Screen ON/OFF** interface is displayed.

Figure 4-94 Screen ON/OFF

Screen Setup	Screen ON/OFF	Screen Timer	Screen Custom Control
Regional Switch	<input checked="" type="checkbox"/>		
Enable			
Switch Times	<input type="text" value="3"/>		
	(1~9)		
Switch Interval	<input type="text" value="200"/>		
	(1~999)ms		
Screen Interval	<input type="text" value="200"/>		
	(1~999)ms		
<input type="button" value="OK"/>			

Step 2 Select the **Regional Switch Enable** check box to enable the function.

Step 3 Configure the parameters.

Table 4-20 Parameters description

Parameter	Description
Switch Times	The times of sending ON/OFF command.
Switch Interval	Interval of sending ON/OFF command.
Screen Interval	The interval for every screen to receive ON/OFF command.

Step 4 Click **OK**.

4.5.5.2.3 Screen Timer

Configure fixed ON/OFF time of every screen. Within the configured period, every screen will be turned ON/OFF at the fixed time.

Step 1 Select **Setup > Display Management > Screen Management > Screen Timer**.

The **Screen Timer** interface is displayed.

Figure 4-95 Screen timer

Step 2 Select **Screen, Block** and **Week**.

Step 3 Select period and configure ON/OFF time.

Step 4 Click **OK**.



After periods of one week have been configured.

- Click **Apply to Screen**, and select another slot in the pop-up interface, to apply this configuration to the slot.
- Click **Apply to Week**, and select another week in the pop-up interface, to apply this configuration to the week.

4.5.5.2.4 Screen Custom Control

Customize screen on and off commands.

Step 1 Select **Setup > Display Management > Screen Management > Screen Custom Control**.

The **Screen Custom Control** interface is displayed.

Figure 4-96 Screen custom control

Step 2 Enter the Customized Manufacturer Name.

Step 3 Select **Enable**.

Step 4 Configure Screen on command and Screen off command.



Configure a hexadecimal number.

Step 5 Click **Save**.

4.5.5.3 Display Setup

You can configure the display parameters, enable main/sub stream auto switch, and window prompt info.

4.5.5.3.1 Configure Display

You can configure the resolution, video mode, hue, brightness and other parameters of the display, and adjust screen display.

Step 1 Select **Setup > Display Management > Display Setup > Display Setup**.

The **Display Setup** interface is displayed.



1-channel 4K high definition (H.265) series, 4-channel 8K high definition (H.265) series, 6-channel 4K high definition (h.265, with 4 input ports) series and 9-channel 4K high definition (h.265, with 4 input ports) series are displayed in Figure 4-98. For other models, refer to Figure 4-97.

Step 2 Configure the parameters.

Figure 4-97 Display setup (1)

The screenshot shows the 'Display Setup' window with the following settings:

- Slot: 0
- Channel: 1
- Resolution: 1920*1080P@60
- Customized:
- Video Mode: DVI
- Audio Mode: Out To SubCard
- Hue: Slider from - to + 50
- Brightness: Slider from - to + 50
- Contrast: Slider from - to + 50
- Saturation: Slider from - to + 50
- Global_Config: Screen/Window Color: Black/Black

Buttons: OK, Refresh

Figure 4-98 Display setup (2)

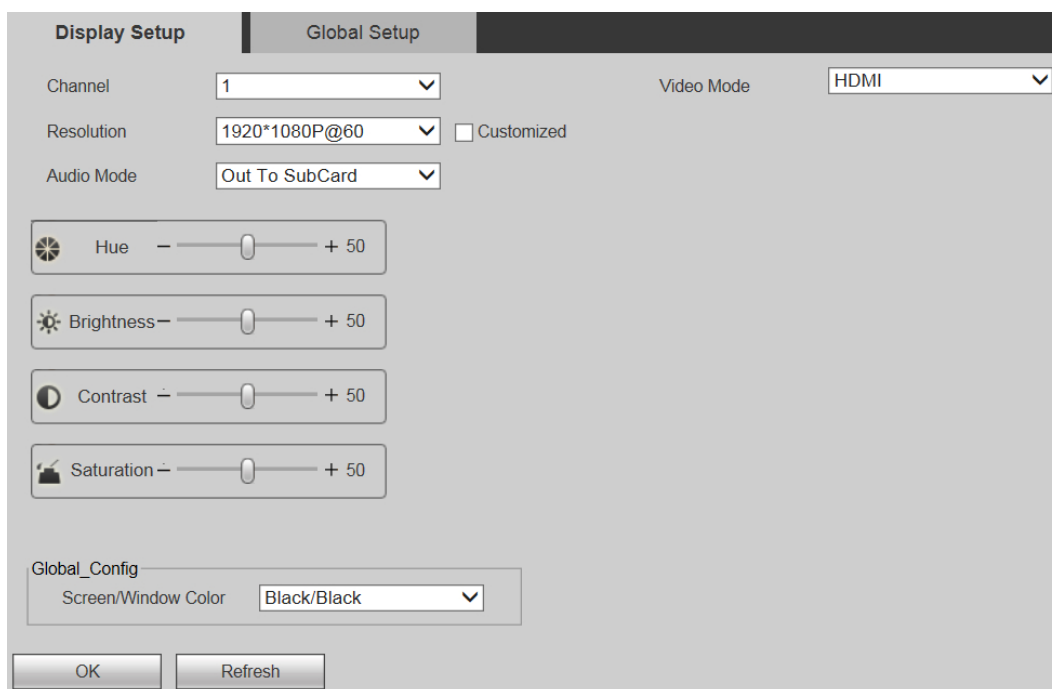



Table 4-21 Parameter description

Parameter	Description
Slot	Configure slot of display.  Device with 9 or less channels does not support this function.
Channel	Configure the channel of display.
Resolution	Configure the resolution of display. Customize the resolution after you select Customized .
Video Mode	Video output mode includes DVI and HDMI.
Audio Mode	N/A.
Hue	Drag the slider to adjust the image hue and saturation.
Brightness	Drag the slider to adjust the image brightness through linear adjustment. The bigger the value is, the brighter the image will become. And vice versa. However, the image is likely to become dim if the value is too big.
Contrast	Drag the slider to adjust the image contrast. The bigger the value is, the more obvious the contrast between the light area and dark area will become. And vice versa. However, if the value is too big, the dark area is likely to become darker and the light area will be over exposed. If the value is too small, the image is likely to become dim.
Saturation	Drag the slider to adjust the color shades. The bigger the value is, the heavier the color will become. And vice versa. This value does not affect the overall brightness of image.
Screen/Window Color	Configure screen and window color, including black/black and blue/green.

Step 3 Click **OK**.

4.5.5.3.2 Global Setup

You can configure to enable main/sub stream auto switch, window prompt info and "do not decode when being covered".

Step 1 Select **Setup > Display Management > Display Setup > Global Setup**.

The **Global Setup** interface is displayed.



The interface of 1-channel 4K high definition (h.265) series is slightly different. The actual interface shall prevail.

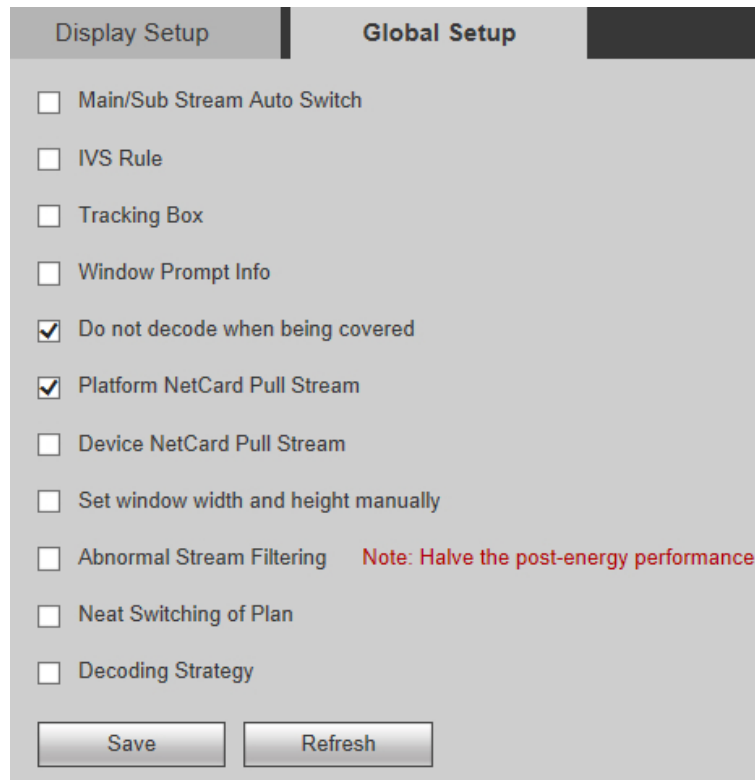

Figure 4-99 Global setup



Step 2 Select the check boxes.

Table 4-22 Global setup parameters description

Parameter	Description
Main/Sub Stream Auto Switch	If main stream is displayed on the window, when the resolution is lower than D1, main stream will automatically switch to sub stream.
IVS Rule	After the camera enables IVS rule function, rule line turns red and flickers if a moving object enters the alarm zone of blue rule line.
Tracking Box	After the camera enables tracking box function, the system selects and tracks moving objects with a green box on the output interface.
Window Prompt Info	Prompt information will be displayed on the window.
Do not decode when being covered	The covered window will pause decoding.
Platform NetCard Pull Stream	Enable platform netcard pull stream function.  1-channel 4K high definition (H.265) series does not support this function.

Parameter	Description
Device NetCard Pull Stream	Enable device netcard pull stream function.  1-channel 4K high definition (H.265) series does not support this function.
Set window width and height manually	Double click window on the video wall to adjust window coordinate and size. See"4.3.2.3 Configuring Window Information."
Abnormal Stream Filtering	The system checks and filters abnormal stream, to prevent green screen.
Neat Switching of Plan	Plan stream will be switched synchronously and neatly, to enhance visual effect.
Decoding Strategy	Select the check box. Fluency adjustment zone is displayed. You can drag the slider to adjust window fluency.  You can only adjust fluency of network signal.

Step 3 Click **Save**.

4.5.5.4 Output Name

You can configure output name and control ID of each channel on the board card. Control ID can correspond to the binding source (such as keyboard), so the binding source can be displayed on the video wall.

- Output name is only used to distinguish channels.
- Select output screens through control ID, and you can configure video wall display of keyboard or other devices.

Step 1 Select **Setup > Display Management > Output Name**.

The **Output Name** interface is displayed.

Figure 4-100 Output name (1)

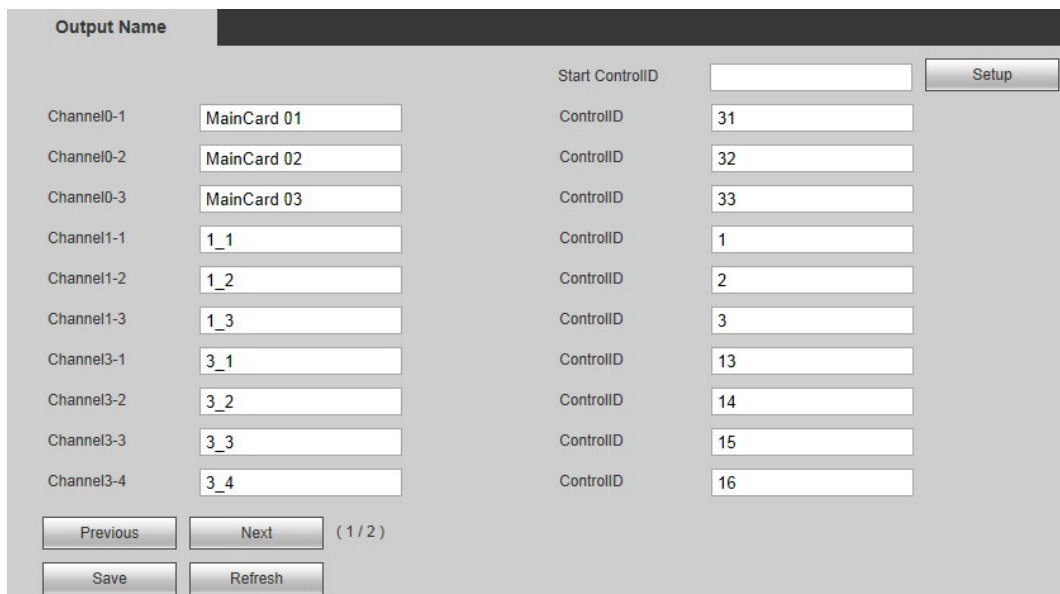

Channel	Output Name	ControlID
Channel0-1	MainCard 01	31
Channel0-2	MainCard 02	32
Channel0-3	MainCard 03	33
Channel1-1	1_1	1
Channel1-2	1_2	2
Channel1-3	1_3	3
Channel3-1	3_1	13
Channel3-2	3_2	14
Channel3-3	3_3	15
Channel3-4	3_4	16

Start ControlID:

Navigation: (1 / 2)

Actions:

Figure 4-101 Output name (2)

Output Name		Start ControlID	<input type="button" value="Setup"/>
Channel1	<input type="text" value="screen 01"/>	ControlID <input type="text" value="1"/>	
Channel2	<input type="text" value="screen 02"/>	ControlID <input type="text" value="2"/>	
Channel3	<input type="text" value="screen 03"/>	ControlID <input type="text" value="3"/>	
Channel4	<input type="text" value="screen 04"/>	ControlID <input type="text" value="7"/>	
Channel5	<input type="text" value="screen 05"/>	ControlID <input type="text" value="8"/>	
Channel6	<input type="text" value="screen 06"/>	ControlID <input type="text" value="9"/>	
Channel7	<input type="text" value="screen 07"/>	ControlID <input type="text" value="10"/>	
Channel8	<input type="text" value="screen 08"/>	ControlID <input type="text" value="11"/>	
Channel9	<input type="text" value="screen 09"/>	ControlID <input type="text" value="12"/>	

(1 / 1)



1-channel 4K high definition (H.265) series, 4-channel 8K high definition (H.265) series, 6-channel 4K high definition (h.265, with 4 input ports) series and 9-channel 4K high definition (h.265, with 4 input ports) series are displayed in Figure 4-101. For other models, refer to Figure 4-100.

Step 2 Configure output name and control ID for each channel.



Enter **Start Control ID** and click **Setup**, so control ID of channels will start from the **Start Control ID**.

Step 3 Click **Save**.

4.5.5.5 Structured Info

Receive structured data info about face, motor vehicle, non-motor vehicle and crowd density, and then display the data on the video wall.

- Face structure: After camera enables face recognition function and video matrix platform enables face structure function, the camera collects video stream and detects face info in the stream. The face info can be displayed on the screen through video matrix platform.
- Human, motor vehicle and non-motor vehicle structure: After camera enables human, motor vehicle and non-motor vehicle recognition function and video matrix platform enables human, motor vehicle and non-motor vehicle structure function, the camera collects video stream and detects human, motor vehicle and non-motor vehicle info in the stream. The human, motor vehicle and non-motor vehicle info can be displayed on the screen through video matrix platform.
- Crowd density: After camera enables crowd density recognition function and video matrix platform enables crowd density structure function, the camera collects video stream and detects crowd density info in the stream. The video stream can be displayed on the screen through video matrix platform. Crowd density is indicated with blue spots. The denser blue spots become, the higher crowd density will be.

Step 1 Select **Setup > Display Management > Structured Info**.

The **Structured Info** interface is displayed.

Figure 4-102 Structured info

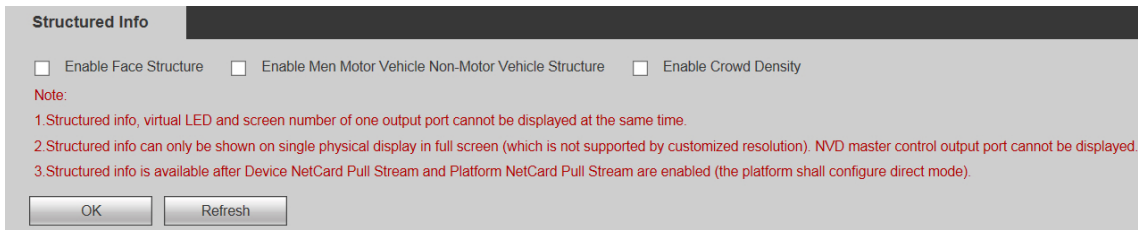

Step 2 Select the structure info you want.

Step 3 Click **OK**.

4.6 Info

You can view device info, including card info, decode info, device info, system status, system log and online user.

4.6.1 Card Info

You can view card status, type, port type and temperature status of the network video decoder.

Select **Info > Device Info > Card Info**. The **Card Info** interface is displayed.



-  : This slot has a card.
-  : This slot does not have a card.

Figure 4-103 Card info

Card Info

Board Quantity(3/5)

Status	Slot	Type	Port Type	Status	Temperature Status	Bios Version
	Main Card	Main Card	HDMI	Normal	56°C	02.00
	Slot1	Enhanced Decoding Board	HDMI	Normal	52°C	02.00
	Slot2					
	Slot3	Enhanced Decoding Board	HDMI	Normal	58°C	02.00,02.00
	Slot4					
	Slot5	Enhanced Decoding Board	HDMI	Normal	50°C	01.06,01.06

Refresh

4.6.2 Decode Info

You can view decoding status, resolution, FPS, data flow and decode flow of the decoding channel.

Select **Info > Device Info > Decode Info**. The **Decode Info** interface is displayed.

Figure 4-104 Decode info

Decode Info

Record Time Interval: 20 (20~120)S

Channel	Status	Resolution	FPS	Data Flow(kb/s)	Decode Flow(kb/s)	Record
405-144_1_1	Monitor	3840 * 2160	25	7623	8277	

You can configure **Record Time Interval** at the top right corner of the interface, and then click . The system records this channel according to the time interval.

4.6.3 Device Info

4.6.3.1 Device Info

You can view device info and card log of network video decoder.

Step 1 Select **Info > Device Info > Device Info**.

The **Device Info** interface is displayed.

Figure 4-105 Device info

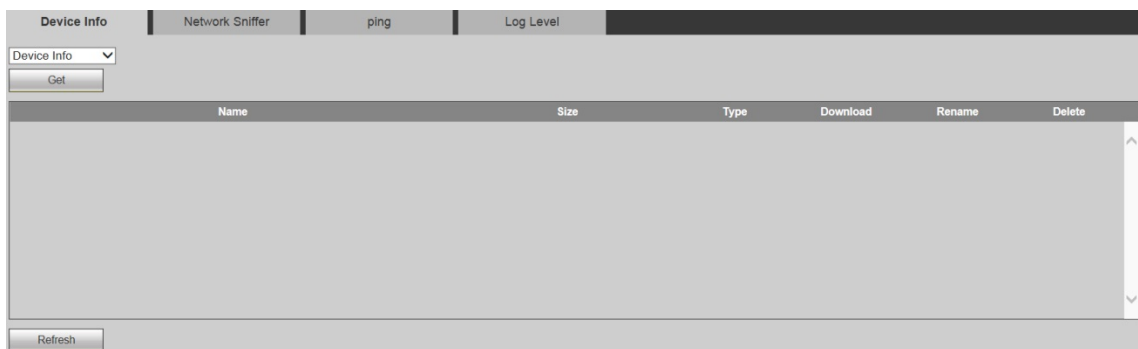



Step 2 Select **Device Info** or **Card Log**, and click **Get**.

The device info or card log is displayed.

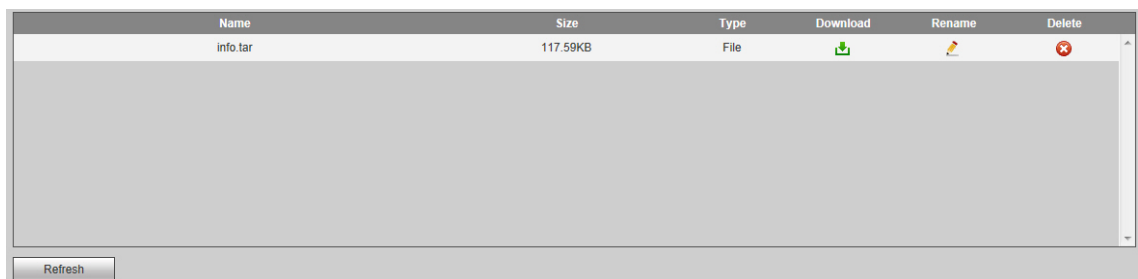
Figure 4-106 Get device info or card log



- Click  to download information file or card log of the device.
- Click  to rename the information file or card log of the device.
- Click  to delete records on the information file or card log interface. If you delete it by mistake, you can get it again.

4.6.3.2 Network Sniffer

Network sniffer is to intercept, resend, edit and transfer the data received and sent through network, so as to inspect network security.

In case of network error, you can carry out sniffer operation on this interface, download the sniffer file to local device, and provide it to technicians to analyze network status.

Step 1 Select **Info > Device Info > Device Info > Network Sniffer**.

The **Network Sniffer** interface is displayed.

Figure 4-107 Network sniffer

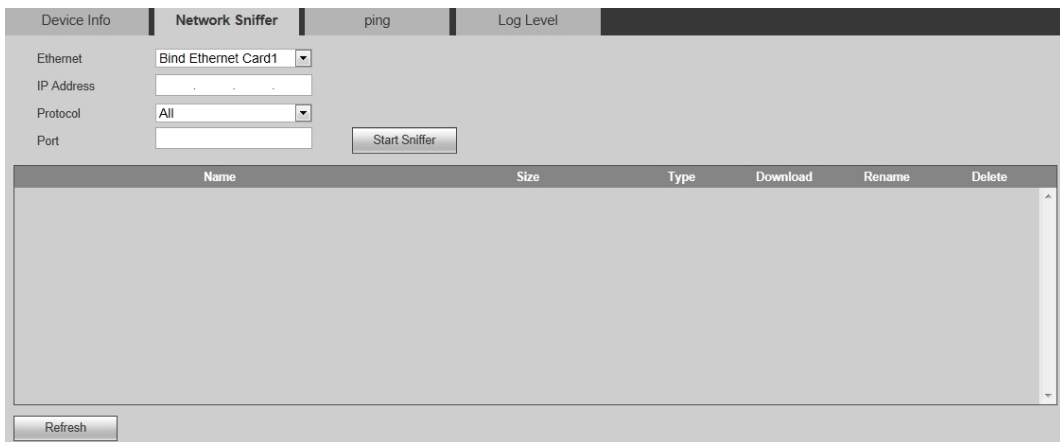

Step 2 Set parameters.

Table 4-23 Network sniffer parameter description

Parameter	Description
Ethernet	Select the net card that has been bound.
IP Address	Set network IP address.
Protocol	Select network protocol, including All, TCP and UDP.
Port	Set network port.



Step 3 Click **Start Sniffer**.

Step 4 After a while, click **Stop Sniffer**.

The obtained data packet is displayed.

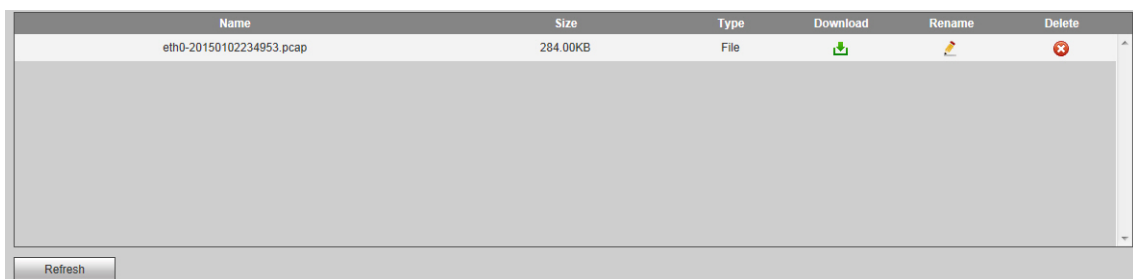
Figure 4-108 Data packet



- Click  to download this sniffer file.
- Click  to rename this sniffer file.
- Click  to delete this sniffer file.

4.6.3.3 Ping

With ping command, check whether camera or network video decoder is connected normally.

Step 1 Select **Info > Device Info > Device Info > Ping**.

The **Ping** interface is displayed.

Figure 4-109 Ping

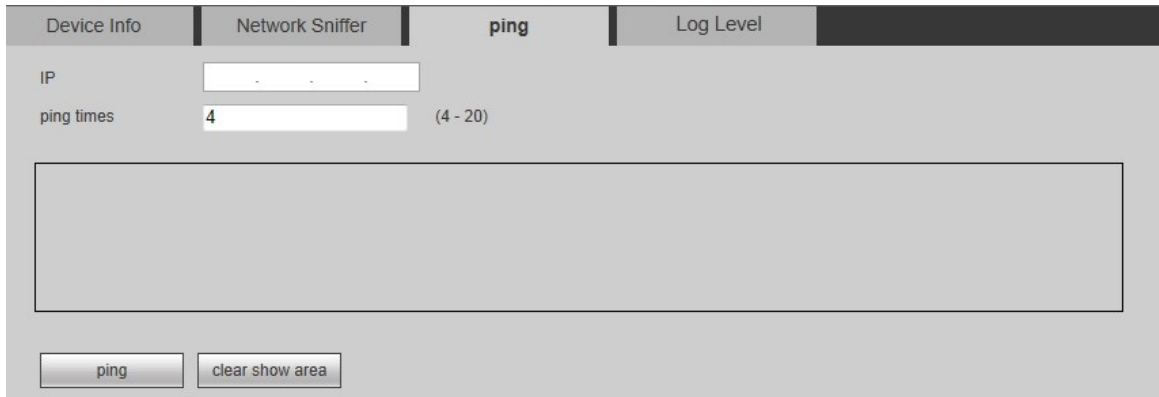

Step 2 Enter the IP address and ping times, and click **Ping**.

After several seconds, ping info is displayed. The network is connected if returned TTL value is less than or equal to 64.

Figure 4-110 Information display

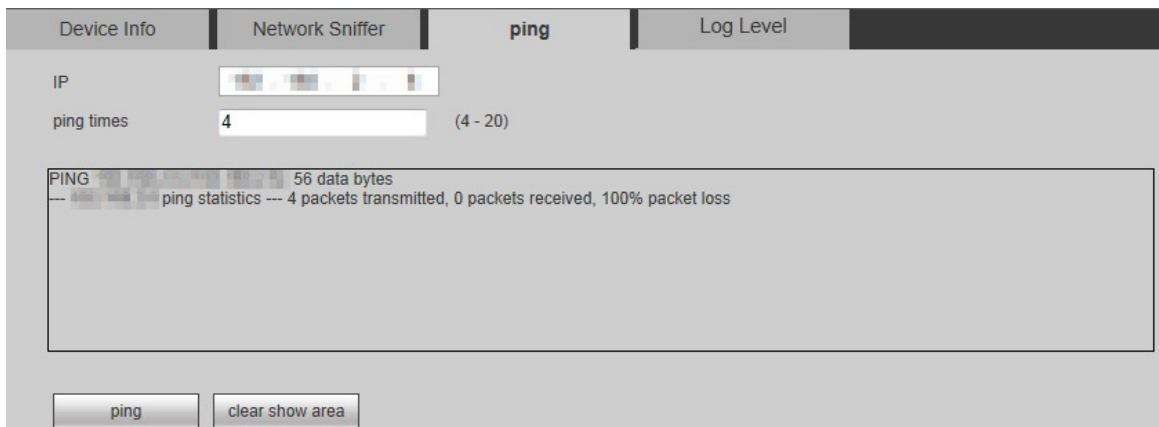

When ping function is enabled, you can open only one web client. Otherwise, ping information might not be displayed completely.

4.6.3.4 Log Level

Configure background printing debugging log level.

Step 1 Select **Info > Device Info > Device Info > Log Level**.

The **Log Level** interface is displayed.

Figure 4-111 Log level

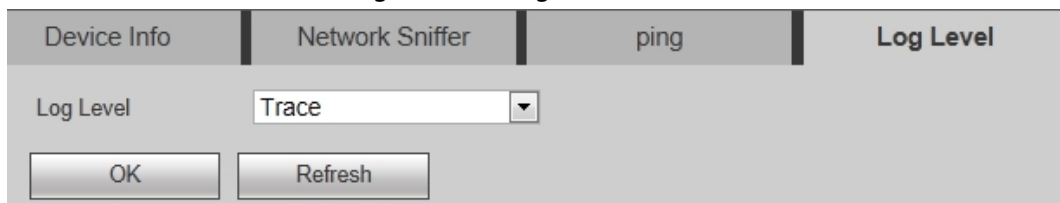

Step 2 Configure log level.

Step 3 Click **OK**.

4.6.4 System Status

You can view network status, fan status, power status, CPU status and memory status of the network video decoder.

Select **Info > Device Info > System Status**. The **System Status** interface is displayed.

Figure 4-112 System status (1)

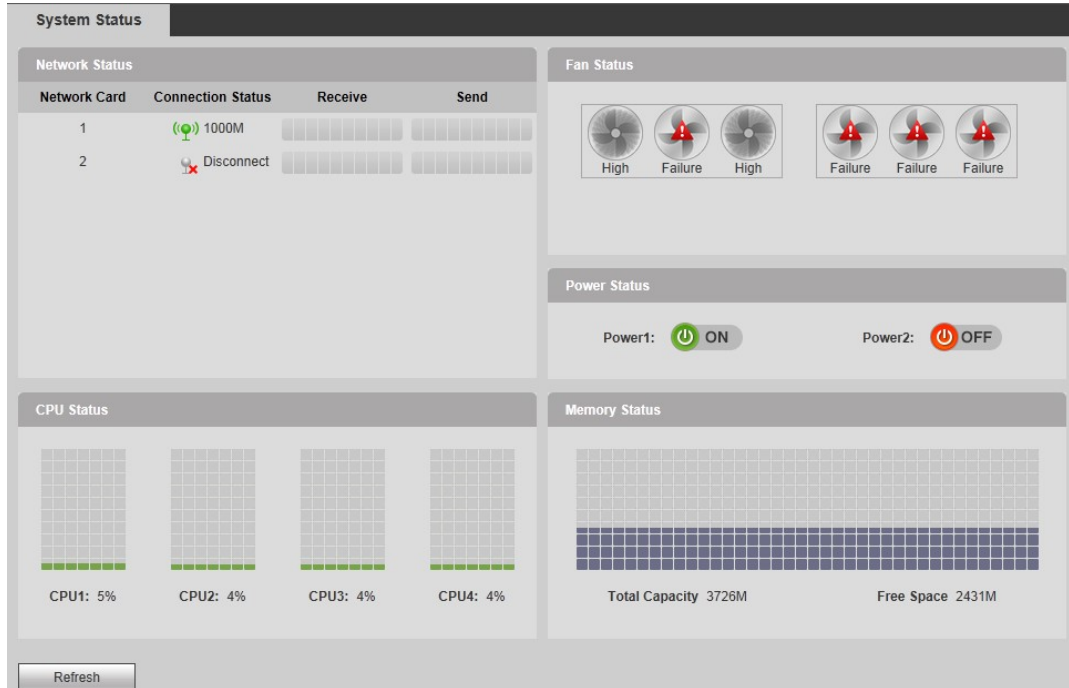
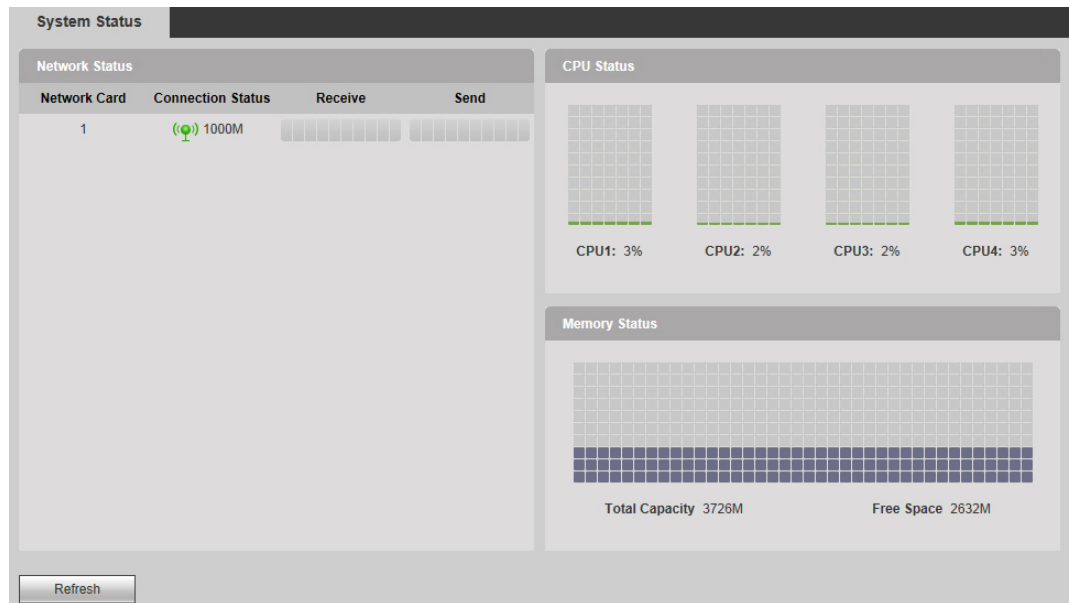

Figure 4-113 System status (2)



The interface of 1-channel 4K high definition (H.265) series, 6-channel 4K high definition (H.265, with 4 input ports) series and 9-channel 4K high definition (H.265, with 4 input ports) series is displayed in Figure 4-113. For other models, see Figure 4-112.

- Network status: Display connection status, data receiving and sending of network card.
- CPU status: Display CPU status of all inserted board cards.
- Fan status: Display fan status.

- Power status: Display status of two power supplies.
- Memory status: Display memory status.

4.6.5 System Log

You can search and view system log information about network video decoder according to time and log type, and backup the log to local PC.

Step 1 Select **Info > Device Info > System Log**.

The **System Log** interface is displayed.

Figure 4-114 System log

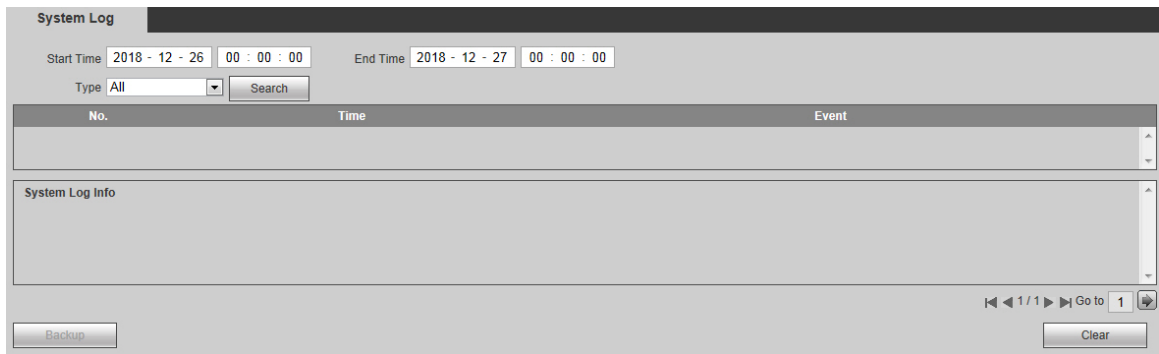

Step 2 Configure **Start Time**, **End Time** and **Type**, and then click **Search**.

The searched logs are displayed.



- Click the log to show details.
- Click **Clear** to clear all log information of the device. Log information cannot be cleared according to types.
- Click **Backup** to back up the searched system log information to the PC under use.

4.6.6 Online User

You can view online users' usernames, groups, IP addresses and other basic information.

Select **Info > Device Info > Online User**. The **Online User** interface is displayed.

Figure 4-115 Online user

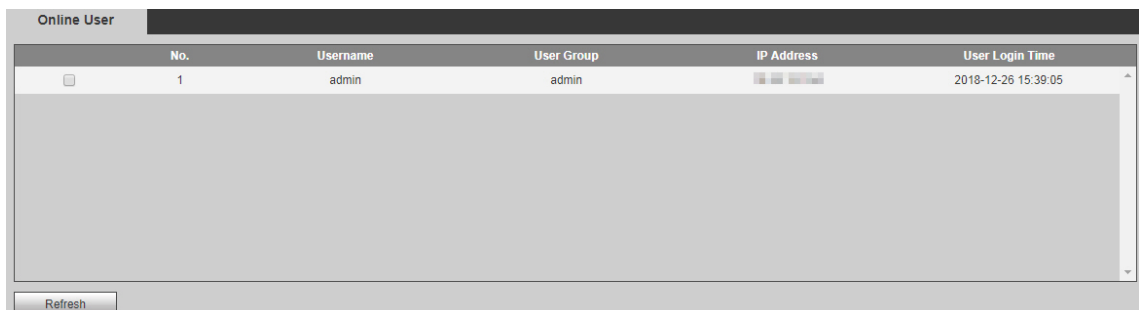

4.6.7 About

Select **Info > Device Info > About**, and you can view version information about this device.

5 Alarm Input /Output Device

Before device connection, pay attention to the following points:

- Alarm Input
Confirm alarm type of alarm input device, and then match alarm type at network end of decoder (for example, in case of grounding alarm, the decoder shall be normally open; otherwise, it shall be normally closed).



Alarm input is effective in case of low electrical level, so the device can be grounded.

If the alarm device is connected to 2 decoders, or one decoder and other devices, use a relay for isolation.

- Alarm Output
The alarm output port of decoder cannot be connected to high-power load (less than 1A). When constructing the output circuit, the excessive current should be prevented from causing damage to the relay. Use a circuit breaker for isolation when applying high-power loads.
- Pay attention to grounding of camera, since poor grounding might lead to chip damage.
Alarm input type can be NO (normal open) or NC (normal close).

5.1 Alarm Port

Figure 5-1 Diagram of alarm port

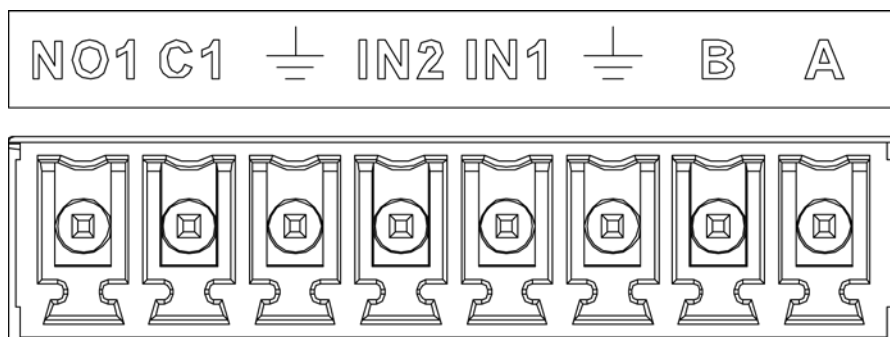

Table 5-1 Alarm port introduction

Parameter	Description
A, B	Control A and B cables of RS-485 device.
⊥	Ground line port
IN1, IN2	Alarm input port
NO1; C1	Alarm output port (NO type)

5.2 Alarm Input Port

- 16-channal alarm input, which can be NO or NC.
- Connect the NC port of alarm detector to alarm input port (ALARM) of decoder.

- When supplying power from external power source to the alarm device, the alarm device should be common-grounded with decoder.

Figure 5-2 Diagram of alarm input

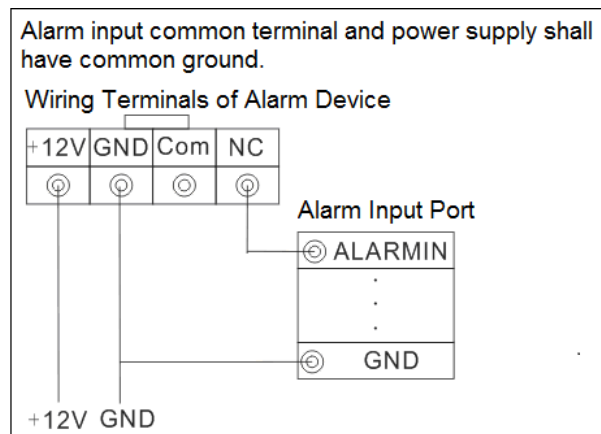

5.3 Alarm Output Port

- It is 8-channel switching volume alarm output (normally open contact), and there should be additional power supply to external alarm device.
- To avoid overload to damage the Device, please refer to relay parameters. See "5.4 Relay Parameters of Alarm Output Port."
- RS-485 A line and B line are used for connecting the line A and line B on the PTZ decoder.

Figure 5-3 Diagram of alarm input port module

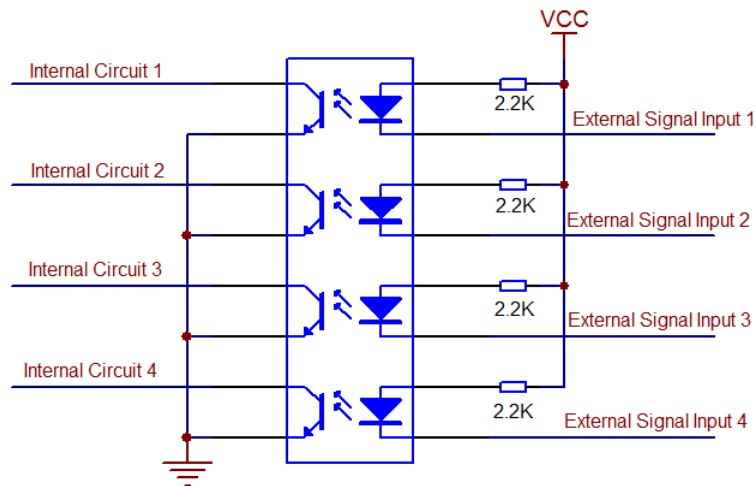
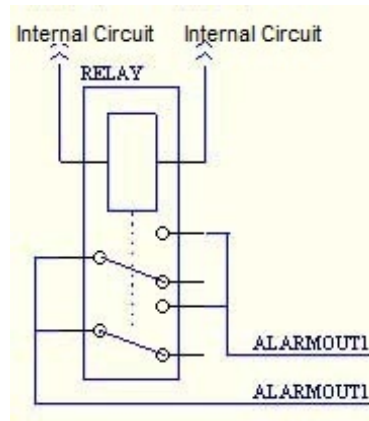

Figure 5-4 Diagram of alarm output port module



5.4 Relay Parameters of Alarm Output Port

Table 5-2 Contact parameter

Parameter	Value
Contact type	1Z
Contact resistance	100 mΩ (DC6V 0.1A)
Contact material	AgNi + Gold plated
Contact load (resistive)	AC125V 0.5A/DC 30V 1A
Maximum switching voltage	AC 125V/DC 60V
Maximum switching current	2A
Maximum switching power	62.5 VA/30 W
Minimum allowable load	1 mA 5V
Mechanical durability	1X10 ⁷ times (300 times/min)
Electrical durability	1X10 ⁵ times (30 times/min)

Appendix 1 Cybersecurity Recommendations

Mandatory actions to be taken for basic device network security:

1. Use Strong Passwords

Please refer to the following suggestions to set passwords:

- The length should not be less than 8 characters.
- Include at least two types of characters; character types include upper and lower case letters, numbers and symbols.
- Do not contain the account name or the account name in reverse order.
- Do not use continuous characters, such as 123, abc, etc.
- Do not use overlapped characters, such as 111, aaa, etc.

2. Update Firmware and Client Software in Time

- According to the standard procedure in Tech-industry, we recommend to keep your device (such as NVR, DVR, IP camera, etc.) firmware up-to-date to ensure the system is equipped with the latest security patches and fixes. When the device is connected to the public network, it is recommended to enable the "auto-check for updates" function to obtain timely information of firmware updates released by the manufacturer.
- We suggest that you download and use the latest version of client software.

"Nice to have" recommendations to improve your device network security:

1. Physical Protection

We suggest that you perform physical protection to device, especially storage devices. For example, place the device in a special computer room and cabinet, and implement well-done access control permission and key management to prevent unauthorized personnel from carrying out physical contacts such as damaging hardware, unauthorized connection of removable device (such as USB flash disk, serial port), etc.

2. Change Passwords Regularly

We suggest that you change passwords regularly to reduce the risk of being guessed or cracked.

3. Set and Update Passwords Reset Information Timely

The device supports password reset function. Please set up related information for password reset in time, including the end user's mailbox and password protection questions. If the information changes, please modify it in time. When setting password protection questions, it is suggested not to use those that can be easily guessed.

4. Enable Account Lock

The account lock feature is enabled by default, and we recommend you to keep it on to guarantee the account security. If an attacker attempts to log in with the wrong password several times, the corresponding account and the source IP address will be locked.

5. Change Default HTTP and Other Service Ports

We suggest you to change default HTTP and other service ports into any set of numbers between 1024–65535, reducing the risk of outsiders being able to guess which ports you are using.

6. Enable HTTPS

We suggest you to enable HTTPS, so that you visit Web service through a secure communication channel.

7. MAC Address Binding

We recommend you to bind the IP and MAC address of the gateway to the device, thus reducing the risk of ARP spoofing.

8. Assign Accounts and Privileges Reasonably

According to business and management requirements, reasonably add users and assign a minimum set of permissions to them.

9. Disable Unnecessary Services and Choose Secure Modes

If not needed, it is recommended to turn off some services such as SNMP, SMTP, UPnP, etc., to reduce risks.

If necessary, it is highly recommended that you use safe modes, including but not limited to the following services:

- SNMP: Choose SNMP v3, and set up strong encryption passwords and authentication passwords.
- SMTP: Choose TLS to access mailbox server.
- FTP: Choose SFTP, and set up strong passwords.
- AP hotspot: Choose WPA2-PSK encryption mode, and set up strong passwords.

10. Audio and Video Encrypted Transmission

If your audio and video data contents are very important or sensitive, we recommend that you use encrypted transmission function, to reduce the risk of audio and video data being stolen during transmission.

Reminder: encrypted transmission will cause some loss in transmission efficiency.

11. Secure Auditing

- Check online users: we suggest that you check online users regularly to see if the device is logged in without authorization.
- Check device log: By viewing the logs, you can know the IP addresses that were used to log in to your devices and their key operations.

12. Network Log

Due to the limited storage capacity of the device, the stored log is limited. If you need to save the log for a long time, it is recommended that you enable the network log function to ensure that the critical logs are synchronized to the network log server for tracing.

13. Construct a Safe Network Environment

In order to better ensure the safety of device and reduce potential cyber risks, we recommend:

- Disable the port mapping function of the router to avoid direct access to the intranet devices from external network.
- The network should be partitioned and isolated according to the actual network needs. If there are no communication requirements between two sub networks, it is suggested to use VLAN, network GAP and other technologies to partition the network, so as to achieve the network isolation effect.
- Establish the 802.1x access authentication system to reduce the risk of unauthorized access to private networks.
- Enable IP/MAC address filtering function to limit the range of hosts allowed to access the device.