



RADIION PIR C RFPR-C12/RFPR-C12-A



en Installation Manual

Bosch Security Systems, Inc.
130 Perinton Parkway
Fairport, NY 14450
USA
www.boschsecurity.com

Bosch Sicherheitssysteme GmbH
Robert-Bosch-Ring 5
85630 Grasbrunn
Germany

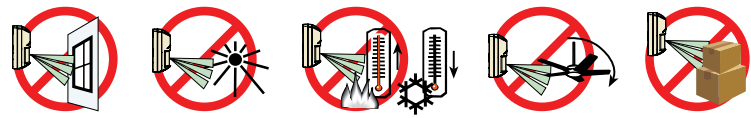

2,1 m - 2,6 m
(7 ft - 8.5 ft)
Recommended:
2,2 m (7.2 ft)

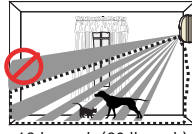
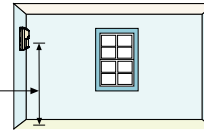

Pet Friendly 2 dogs ≤ 13 kg each (30 lb each) or up to two cats

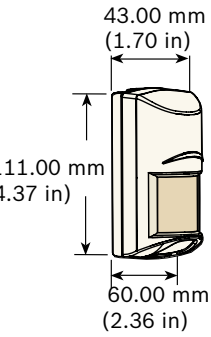

UL - only models RFPR-12-A are evaluated by UL
UL639: Standard for Intrusion-Detection Units (Pet Friendly Immunity is not a feature of UL639)

FCC, Part 15 INCERT B-509-0070
RFPR-C12 only



AFNOR - only
RFPR-C12 is certified



AFNOR: www.marque-nf.com
CNPP: www.cnpp.com
NF324-H58
Certificate number 2620200019
RTC 50131-2-2

Autosurveillance à l'ouverture immunité champ magnétique. Test sans champ de vision verticale et sans immunité aux animaux. Only the mounting without swivel-bracket is compliant with standard.



EN 50131-2-2
EN 50131-5-3
Grade 2
Environment Class II

Bosch YouTube Channel:



ANATEL

Brazil	ANATEL	Este equipamento opera em caráter secundário, isto é, não tem direito a proteção contra interferência prejudicial, mesmo de estações do mesmo tipo, e não pode causar interferência a sistemas operando em caráter primário
--------	--------	---



P/N: F.01U.261.834 - B810
P/N: F.01U.261.835 - RFRC-OPT
P/N: F.01U.304.662 - Transmitter

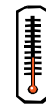
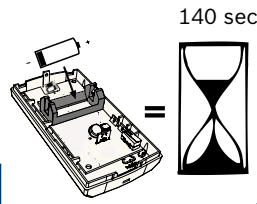

Functional range: -10°C to +55°C (+14°F to +131°F)
UL only: 0°C to +49°C (+32°F to +120°F)
EN 50130-5 Class II: -10°C to +55°C (+14°F to +131°F)
IP30/IK04



0 - 93% Non-condensing humidity

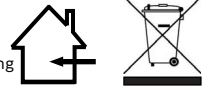

Duracell DL123A, 3 VDC
Panasonic CR123A, 3 VDC
Sanyo CR123A, 3 VDC

1 |

2 |

3 |

4 |

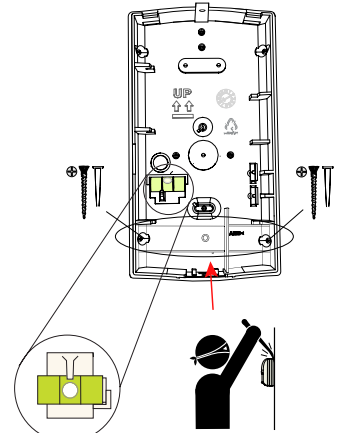
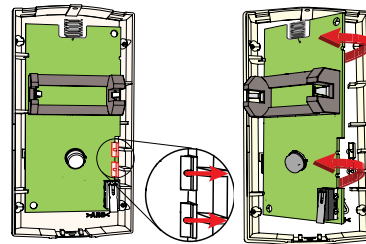
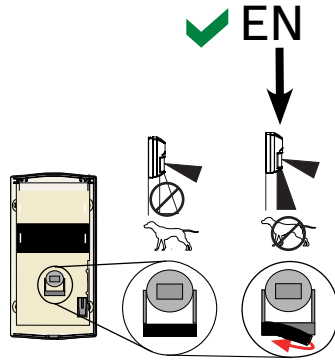
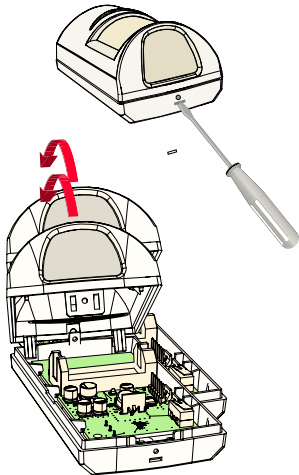

5 |

6 |

7 |

8 |

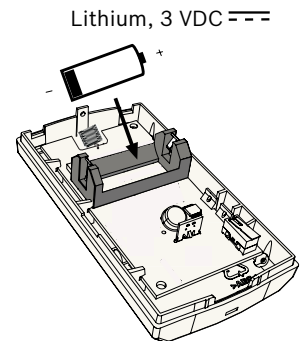
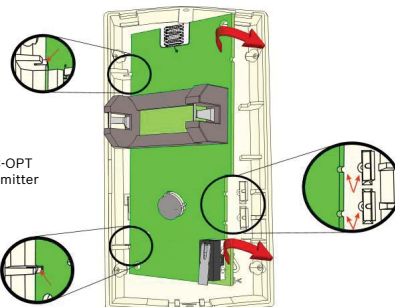
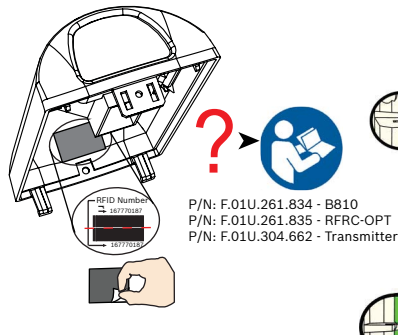
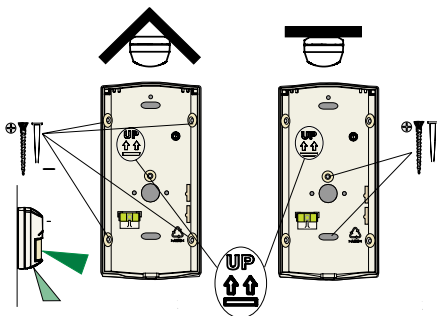

Lithium, 3 VDC



P/N: F.01U.261.834 - B810
P/N: F.01U.261.835 - RFRC-OPT
P/N: F.01U.304.662 - Transmitter

9 |

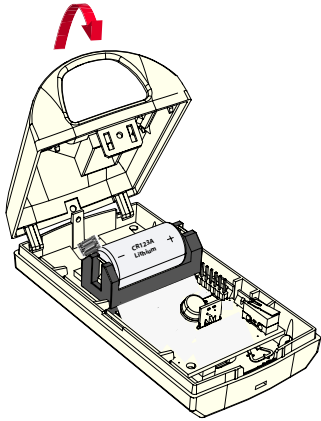

10 |

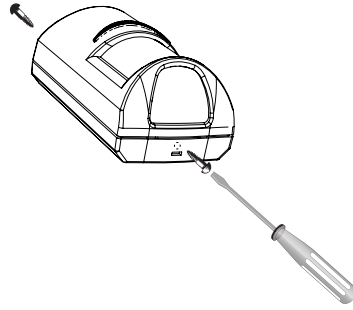

11 |

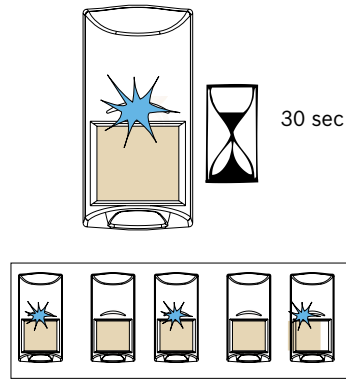

12 |

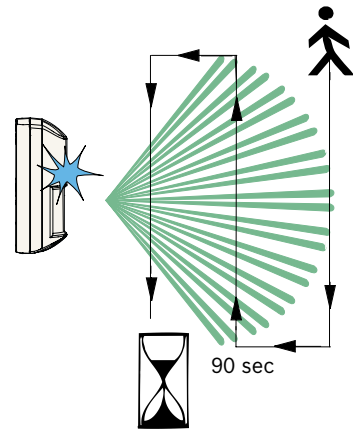

13 |

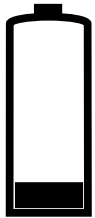

P/N: F.01U.261.834 - B810
 P/N: F.01U.261.835 - RFRC-OPT
 P/N: F.01U.304.662 - Transmitter

Top View

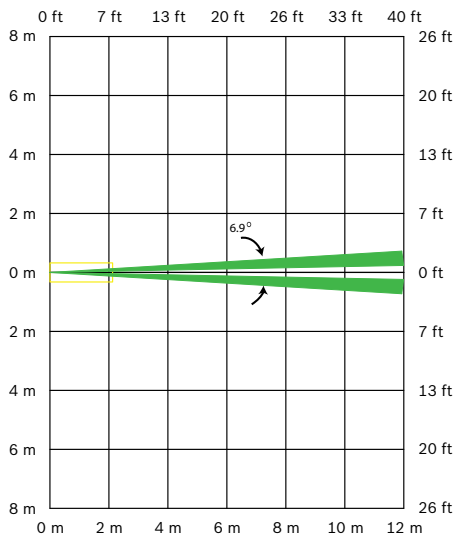

Side View

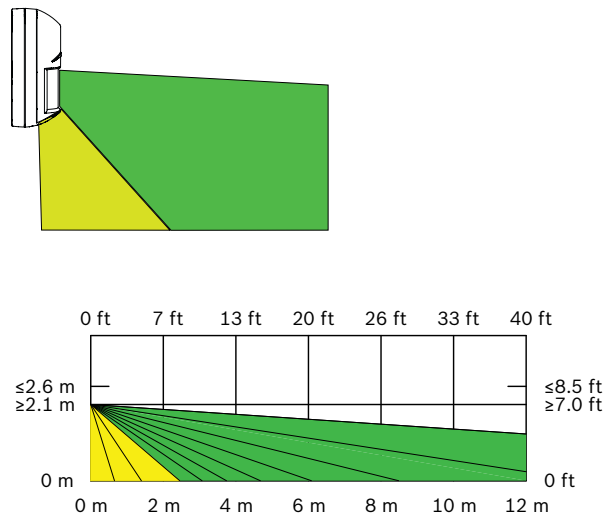

Copyright

This document is the intellectual property of Bosch Security Systems, Inc. and is protected by copyright. All rights reserved.

Trademarks

All hardware and software product names used in this document are likely to be registered trademarks and must be treated accordingly.

Bosch Security Systems, Inc. product manufacturing dates

Use the serial number located on the product label and refer to the Bosch Security Systems, Inc. website at <http://www.boschsecurity.com/datecodes/>

