

User Manual

InBio160/260/460 Pro Access Control Panel

Date: November 2020

Doc Version: 1.0

English

Thank you for choosing our product. Please read the instructions carefully before operation. Follow these instructions to ensure that the product is functioning properly. The images shown in this manual are for illustrative purposes only.



For further details, please visit our Company's website
www.zkteco.com.

Copyright © 2020 ZKTECO CO., LTD. All rights reserved.

Without the prior written consent of ZKTeco, no portion of this manual can be copied or forwarded in any way or form. All parts of this manual belong to ZKTeco and its subsidiaries (hereinafter the "Company" or "ZKTeco").

Trademark

ZKTeco is a registered trademark of ZKTeco. Other trademarks involved in this manual are owned by their respective owners.

Disclaimer

This manual contains information on the operation and maintenance of the ZKTeco equipment. The copyright in all the documents, drawings, etc. in relation to the ZKTeco supplied equipment vests in and is the property of ZKTeco. The contents hereof should not be used or shared by the receiver with any third party without express written permission of ZKTeco.

The contents of this manual must be read as a whole before starting the operation and maintenance of the supplied equipment. If any of the content(s) of the manual seems unclear or incomplete, please contact ZKTeco before starting the operation and maintenance of the said equipment.

It is an essential pre-requisite for the satisfactory operation and maintenance that the operating and maintenance personnel are fully familiar with the design and that the said personnel have received thorough training in operating and maintaining the machine/unit/equipment. It is further essential for the safe operation of the machine/unit/equipment that personnel has read, understood and followed the safety instructions contained in the manual.

In case of any conflict between terms and conditions of this manual and the contract specifications, drawings, instruction sheets or any other contract-related documents, the contract conditions/documents shall prevail. The contract specific conditions/documents shall apply in priority.

ZKTeco offers no warranty, guarantee or representation regarding the completeness of any information contained in this manual or any of the amendments made thereto. ZKTeco does not extend the warranty of any kind, including, without limitation, any warranty of design, merchantability or fitness for a particular purpose.

ZKTeco does not assume responsibility for any errors or omissions in the information or documents which are referenced by or linked to this manual. The entire risk as to the results and performance obtained from using the information is assumed by the user.

ZKTeco in no event shall be liable to the user or any third party for any incidental, consequential, indirect, special, or exemplary damages, including, without limitation, loss of business, loss of profits, business interruption, loss of business information or any pecuniary loss, arising out of, in connection with, or

relating to the use of the information contained in or referenced by this manual, even if ZKTeco has been advised of the possibility of such damages.

This manual and the information contained therein may include technical, other inaccuracies or typographical errors. ZKTeco periodically changes the information herein which will be incorporated into new additions/amendments to the manual. ZKTeco reserves the right to add, delete, amend or modify the information contained in the manual from time to time in the form of circulars, letters, notes, etc. for better operation and safety of the machine/unit/equipment. The said additions or amendments are meant for improvement /better operations of the machine/unit/equipment and such amendments shall not give any right to claim any compensation or damages under any circumstances.

ZKTeco shall in no way be responsible (i) in case the machine/unit/equipment malfunctions due to any non-compliance of the instructions contained in this manual (ii) in case of operation of the machine/unit/equipment beyond the rate limits (iii) in case of operation of the machine and equipment in conditions different from the prescribed conditions of the manual.

The product will be updated from time to time without prior notice. The latest operation procedures and relevant documents are available on <http://www.zkteco.com>

If there is any issue related to the product, please contact us.

ZKTeco Headquarters

Address ZKTeco Industrial Park, No. 26, 188 Industrial Road,
Tangxia Town, Dongguan, China.

Phone +86 769 - 82109991

Fax +86 755 - 89602394

For business-related queries, please write to us at sales@zkteco.com.

To know more about our global branches, visit www.zkteco.com.

About the Company

ZKTeco is one of the world's largest manufacturer of RFID and Biometric (Fingerprint, Facial, Finger-vein) readers. Product offerings include Access Control readers and panels, Near & Far-range Facial Recognition Cameras, Elevator/floor access controllers, Turnstiles, License Plate Recognition (LPR) gate controllers and Consumer products including battery-operated fingerprint and face-reader Door Locks. Our security solutions are multi-lingual and localized in over 18 different languages. At the ZKTeco state-of-the-art 700,000 square foot ISO9001-certified manufacturing facility, we control manufacturing, product design, component assembly, and logistics/shipping, all under one roof.

The founders of ZKTeco have been determined for independent research and development of biometric verification procedures and the productization of biometric verification SDK, which was initially widely applied in PC security and identity authentication fields. With the continuous enhancement of the development and plenty of market applications, the team has gradually constructed an identity authentication ecosystem and smart security ecosystem, which are based on biometric verification techniques. With years of experience in the industrialization of biometric verifications, ZKTeco was officially established in 2007 and now has been one of the globally leading enterprises in the biometric verification industry owning various patents and being selected as the National High-tech Enterprise for 6 consecutive years. Its products are protected by intellectual property rights.

About the Manual

This manual introduces the operations of the InBio160/260/460 Pro Access Control Panel.

All figures displayed are for illustration purposes only. Figures in this manual may not be exactly consistent with the actual products.

Document Conventions

Conventions used in this manual are listed below:

GUI Conventions

For Software	
Convention	Description
Bold font	Used to identify software interface names e.g. OK, Confirm, Cancel
>	Multi-level menus are separated by these brackets. For example, File > Create > Folder.
For Device	
Convention	Description
< >	Button or key names for devices. For example, press <OK>
[]	Window names, menu items, data table, and field names are inside square brackets. For example, pop up the [New User] window
/	Multi-level menus are separated by forwarding slashes. For example, [File/Create/Folder].

Symbols





Convention	Description
	This implies about the notice or pays attention to, in the manual
	The general information which helps in performing the operations faster
	The information which is significant
	Care taken to avoid danger or mistakes
	The statement or event that warns of something or that serves as a cautionary example.

Table of Contents

- 1 SAFETY INSTRUCTIONS.....6**
- 1.1 IMPORTANT SECURITY INSTRUCTIONS..... 6
- 1.2 INSTALLATION INSTRUCTIONS..... 7
- 2 SYSTEM INTRODUCTION.....9**
- 2.1 SYSTEM FUNCTIONAL PARAMETERS..... 9
- 2.2 PRODUCT TECHNICAL PARAMETERS 9
- 2.3 CONTROL PANEL INDICATORS..... 10
- 3 INSTALLATION AND CONNECTION 11**
- 3.1 INSTALLATION PROCEDURE 11
- 3.2 INSTALLATION OF ACCESS CONTROL PANEL WIRES..... 12
- 3.3 CONTROL PANEL SYSTEM INSTALLATION..... 13
- 3.4 CONTROL PANEL CONNECTION TERMINALS 14
- 3.5 CONNECTION WITH DOOR SENSORS, EXIT SWITCHES, AUXILIARY INPUT DEVICES, AND RS485 EXTENSION
COMMUNICATION..... 17
- 3.6 CONNECTION WITH READERS 19
- 3.7 RELAY OUTPUT CONNECTION..... 21
- 3.8 ACCESS CONTROL OPERATOR PANEL SYSTEM POWER SUPPLY STRUCTURE 23
- 4 EQUIPMENT COMMUNICATION 25**
- 4.1 ACCESS CONTROL NETWORKING WIRES AND WIRING 25
- 4.2 TCP/IP COMMUNICATION..... 26
- 4.3 RS485 COMMUNICATION 26
- 4.4 DIP SWITCH SETTINGS..... 27
- 4.5 ZKPANELWEB 30
- 5 STATEMENT ON THE RIGHT TO PRIVACY 37**
- 6 ECO-FRIENDLY OPERATION..... 38**

1 Safety Instructions

1.1 Important Security Instructions

1. Read and follow the instructions carefully before operation. Please keep the instructions for future reference.
2. Accessories: Please use the accessories recommended by the manufacturer or delivered with the product. Other accessories are not recommended, including major alarming systems and monitoring systems. The primary alarming and monitoring system should comply with the local applicable fire-prevention and security standards.
3. Installation cautions: Do not place this equipment on an unstable table, tripod mount, support, or base, lest the equipment falls and get damaged or any other undesirable outcome resulting in severe personal injuries. Therefore, it is essential to install the equipment as instructed by the manufacturer.
4. All peripheral devices must be grounded.
5. No external connection wires can be exposed. All the connections and idle wire ends must be wrapped with insulating tapes to prevent any damage to the equipment by accidental contact of the exposed wires.
6. Repair: Do not attempt to have an unauthorized repair of the equipment. Disassembly or detachment is risky and likely to cause shock. All repairs should be done by a qualified technician.
7. If any of the following cases arise, disconnect the power supply from the equipment first and intimate the technician immediately.
 - ✧ *The power cord or connector is damaged.*
 - ✧ *Any liquid or material spilled into the equipment.*
 - ✧ *The equipment is wet or exposed to bad weather (rain, snow, etc.).*
 - ✧ *If the equipment cannot work properly, even if it is operated as instructed, please be sure to adjust only the control components specified in the operating instructions. Incorrect adjustments on other control components may cause damage to the equipment; even the equipment may fail to operate permanently.*
 - ✧ *The equipment falls, or its performance changes dramatically.*
8. Replacing components: If it is necessary to replace a component, only the authorized technician can replace the accessories specified by the manufacturer.
9. Security inspection: After the equipment is repaired, the technician must conduct security inspection to ensure proper working of the equipment.

10. Power supply: Operate the equipment with only the type of power supply indicated on the label. Contact the technician for any uncertainty about the type of power supply.



Violation of any of the following cautions is likely to result in personal injury or equipment failure. We will not be responsible for the damages or injuries caused thereby.

- Before installation, switch off the external circuit (that supplies power to the system), including locks.
- Before connecting the equipment to the power supply, ensure the output voltage is within the specified range.
- Never connect the power before completion of installation.

1.2 Installation Instructions

1. The conduits of wires under relay must match with the metal conduits; other wires can use PVC conduits, to prevent failure caused by rodent damage. The Control panel is designed with proper antistatic, lightning-proof, and leakage-proof functions, ensure its chassis and the AC ground wire are correctly connected and the AC ground wire is grounded physically.
2. It is recommended not to plug/unplug connection terminals frequently when the system is powered on. Be sure to unplug the connection terminals before starting any relevant welding job.
3. Do not detach or replace any control panel chip without permission, and an unpermitted operation may cause damage to the control panel.
4. It is recommended not to connect any other auxiliary devices without permission. All non-routine operations must be communicated to our engineers in advance.
5. A control panel should not share the same power socket with any other large-current device.
6. It is preferable to install card readers and buttons at the height of **1.4 to 1.5m** above the ground or subject to customers' usual practice for proper adjustment.
7. It is advised to install control panels at places where maintenance is easy, like **a weak electric well**.
8. It is strongly recommended that the exposed part of any connection terminal should **not be longer than 4mm**, and specialized clamping tools may be used to avoid short-circuit or communication failure resulting from accidental contact with excessively exposed wires.
9. To save access control event records, export the data periodically from control panels.
10. Prepare countermeasures according to application scenarios for unexpected power failure, like **selecting power supply with UPS**.
11. To protect the access control system against the self-induced electromotive force generated by an electronic lock at the instant of switching off/on, it is necessary to **connect a diode in parallel**

(please use the FR107 delivered with the system) with the electronic lock to release the self-induced electromotive force during onsite connection for application of the access control system.

12. It is recommended that an electronic lock and a control panel should use separate power supplies.
13. It is recommended to use the power supply delivered with the system as the control panel power supply.
14. In a place with substantial magnetic interference, galvanized steel pipes or shielded cables are recommended, and proper grounding is required.



2 System Introduction

The Access Control management system is a new modernized security management system, which is an effective measure of security and protection management. It is mainly used to manage the entrances and exits of highly secured places, such as banks, hotels, equipment rooms, offices, smart communities, and factories.

2.1 System Functional Parameters

- High-speed 32-bit 1.2GHz CPU, 128M RAM, and 256M Flash.
- Embedded LINUX operating system.
- One-door/two-door two-way access or four-door one-way access.
- Fingerprint capacity: 20,000.
- A maximum of 60,000 cardholders and 100,000 offline event records.
- Support of multiple Wiegand card formats and a password keypad, compatible with various types of cards.
- Use Ethernet and RS485 industrial bus dual communication technology, for reliable communications.
- Control Panel with a watchdog (hardware) built in to prevent a crash.
- Over-current, over-voltage, and inverse-voltage protection for the input of the power supply to the control panel.
- Over-current protection for the power supply to card readers.
- Instant over-voltage protection for all input/output ports.
- Instant over-voltage protection for communication ports.

2.2 Product Technical Parameters

- Working Power supply: Rated voltage 12V ($\pm 20\%$) DC, rated current is 2A.
- Working environment: Temperature 0°C to 45°C; Humidity 20% to 80%.
- Electronic lock relay output: The maximum switching voltage is 12V(DC); The maximum switching current is 2A.
- Auxiliary relay output: The maximum switching voltage is 12V(DC); The maximum switching current is 1.25A.
- The detachable connection terminals are made of alloy-steel non-magnetic flange materials.
- Outline dimensions of the control PCB: 181mm(length) \times 106mm (width) for InBio160/260 Pro; 226mm (length) \times 106mm (width) for InBio460 Pro.
- External box dimensions: 350(L)mm \times 300(W)mm \times 90(H)mm.

Valve regulated lead-acid battery:

- Constant voltage charge voltage regulation

- Cycle use : 14.5V~14.9V(25)
- Initial current: less than 2.88A1
- Standby use: 13.6V~13.8V(25)
- Capacity: 12V, 7.2Ah/20hr
- Battery Type: LC-RA127R2T1

Battery Caution:

- Do not charge in a gas tight container.
- Do not short the battery terminals.
- Do not incinerate.
- Flush with water at once if contact is made with electrolyte (Acid).
- Do not attempt to disassemble the battery.

2.3 Control Panel Indicators

When the InBio160/260/460 Pro is powered on, normally the POWER indicator (red) is lit constantly, the RUN indicator (green) shall flash slowly (indicating the system is normal), and other indicators are all off.

- **LINK indicator (green):** indicates proper TCP/IP connection if it is lit constantly;
- **ACT indicator (yellow):** indicates transmission of TCP/IP data if it flashes;
- **EXT RS485 (TX) indicator (yellow):** indicates sending of 485 data if it flashes;
- **EXT RS485 (RX) indicator (green):** indicates receiving of 485 data if it flashes;
- **CARD indicator (yellow):** indicates input of Wiegand signal if it is lit.

Indicator Diagram:

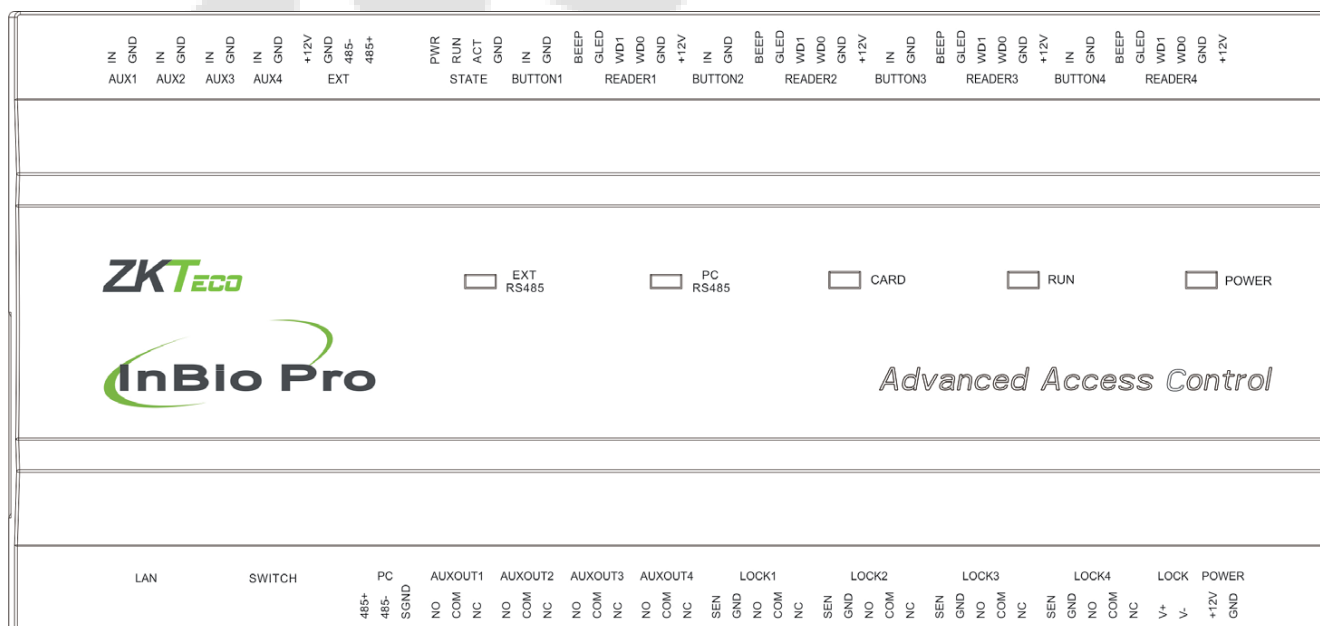
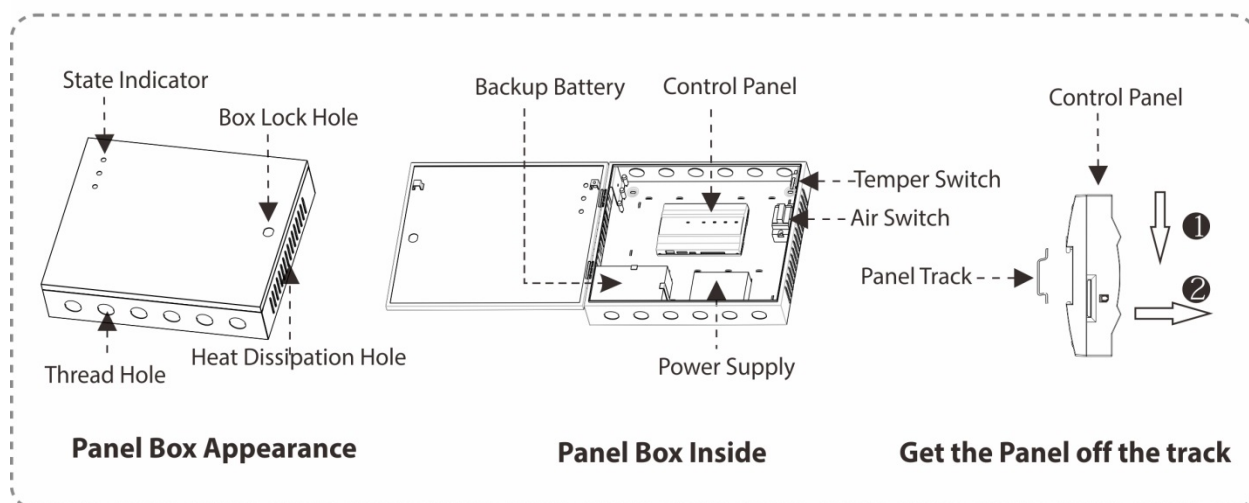

Figure 2-1 Indicators in the InBio460 Pro

3 Installation and Connection

3.1 Installation Procedure

- **Appearance and Internal of the panel box:**



- **Installation steps for the control panel:**

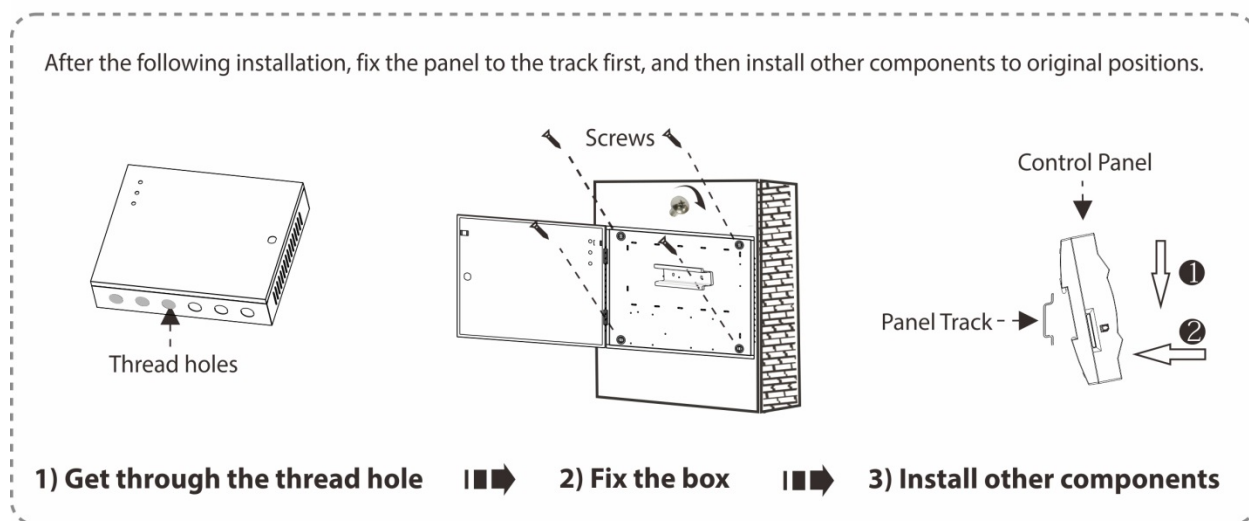

3.2 Installation of Access Control Panel Wires

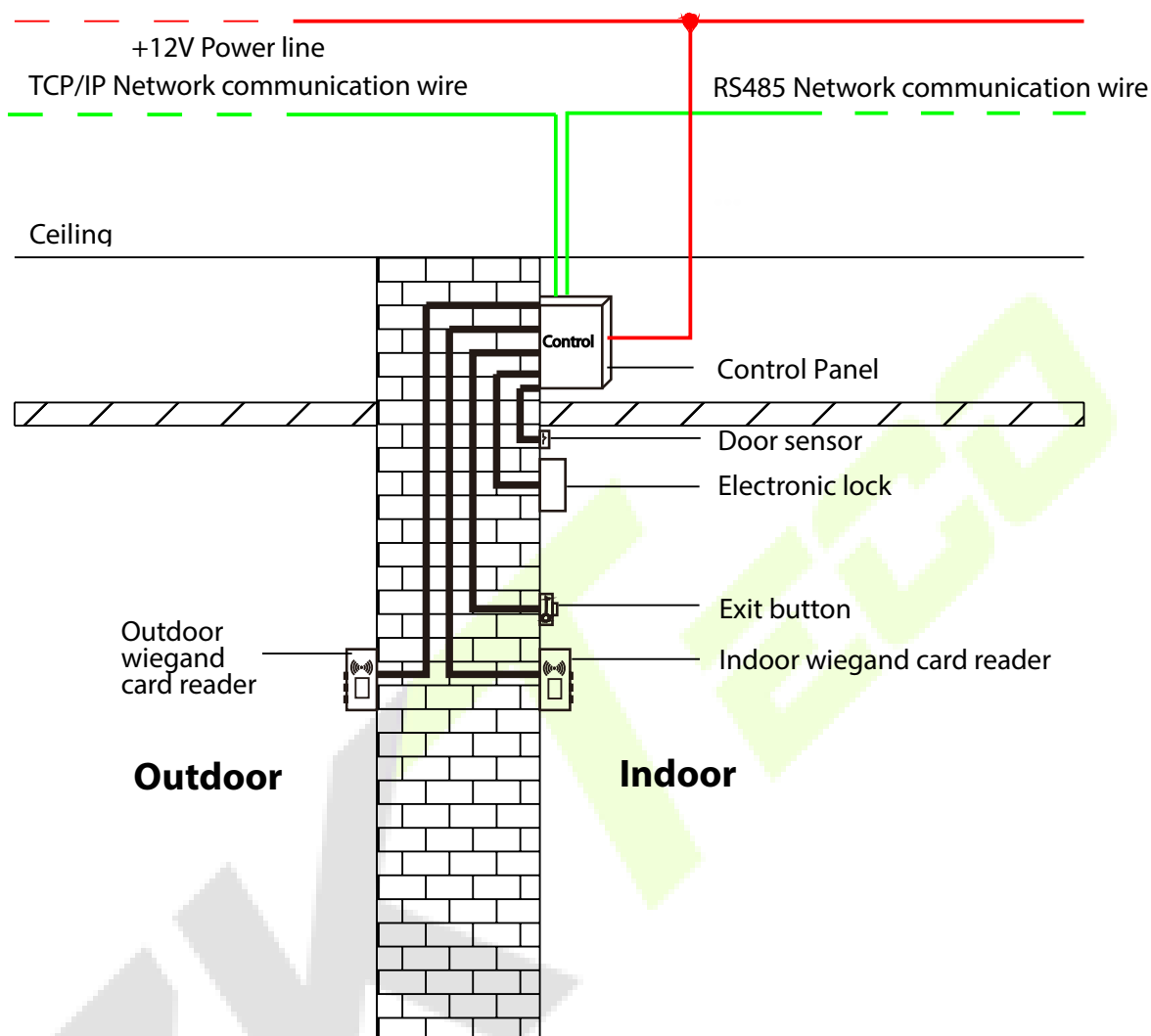

Figure 3-1 Access Control Panel Wire Installation Diagram

Remarks:

- Ensure the power supply is disconnected before connecting the wires; otherwise, it may cause severe damage to the equipment.
- The access control wires must be separated according to heavy and light current; the control panel wires, electronic lock wires, and exit button wires must run through their casing pipes, respectively.

3.3 Control Panel System Installation

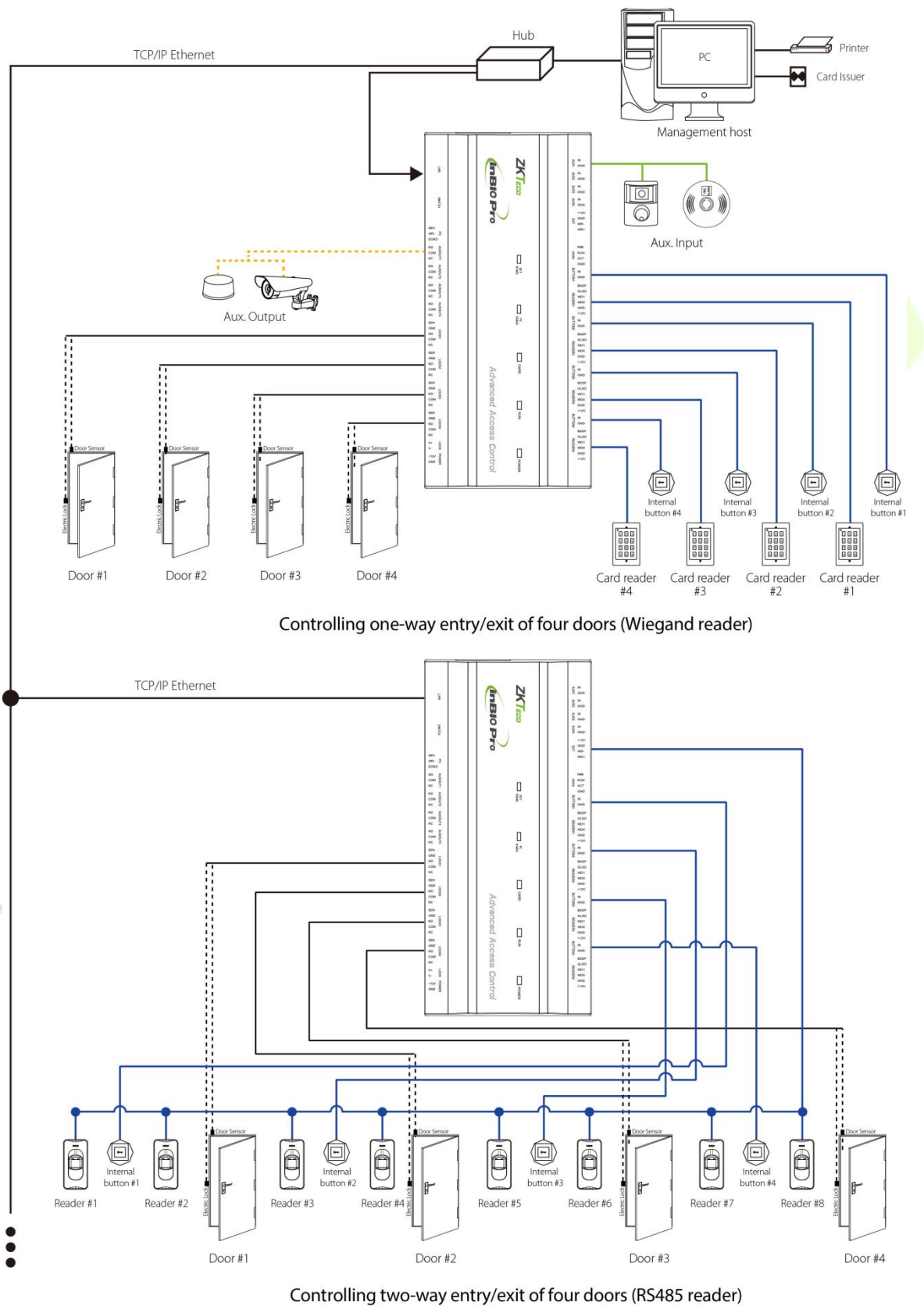

Figure 3-2 Schematic Diagram of System Installation

Note: The diagram above takes the InBio460 Pro for example. By contrast, only one-door two-way access is applicable to the InBio160 Pro system; only two-door one-way or two-door two-way access is applicable to the InBio460 Pro system.

The access control management system consists of two parts: Management Workstation (PC) and Control panel. The management workstation and control panel communicate through TCP/IP and RS485 network. On a 485 bus, each management workstation can be connected with up to 63 InBio Pro control operator panels (preferably fewer than 32). The communication wires should be kept away from high-voltage wires as far as possible and should be neither routed in parallel with nor bundled with power wires.

A management workstation is a PC connected with the network. By running the access control management software installed in the PC, access control management personnel can remotely perform various management functions, like adding/deleting a user, viewing event records, opening/closing doors, and monitoring the status of each door in real-time.

3.4 Control Panel Connection Terminals

InBio160 Pro Terminal connection diagram

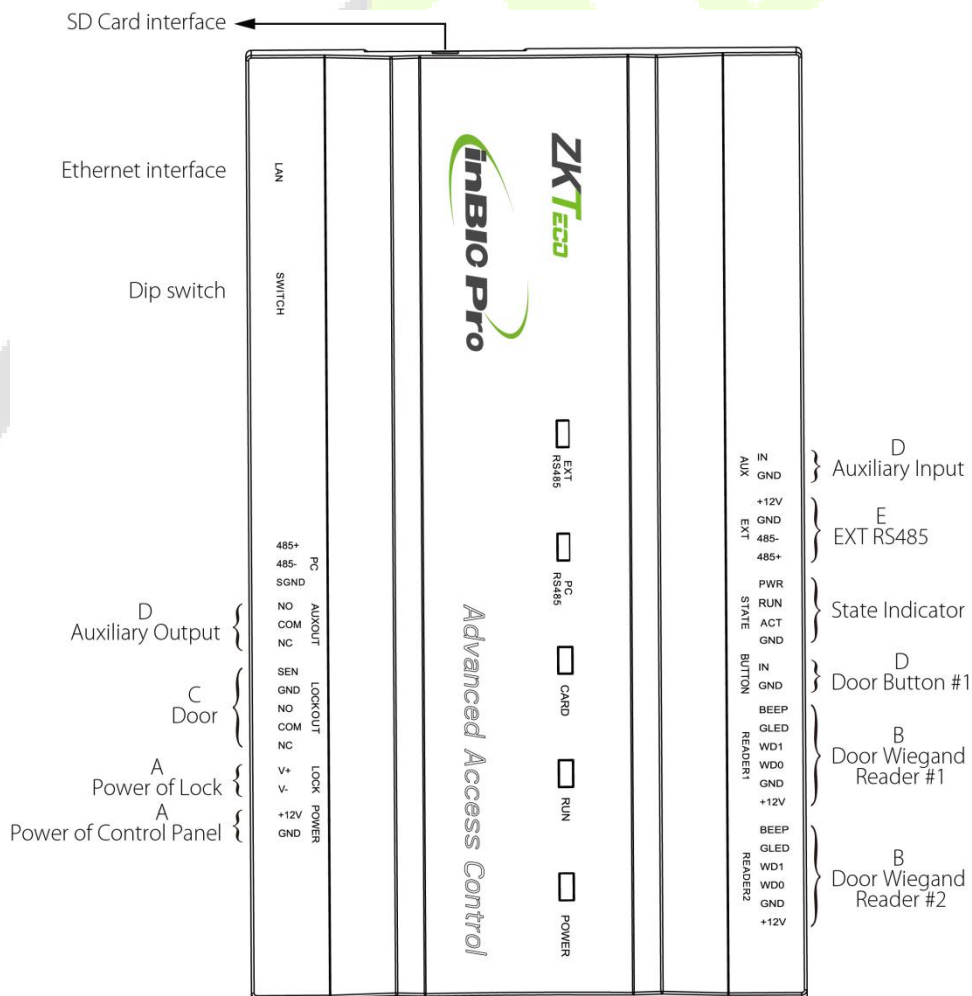

InBio260 Pro Terminal connection diagram

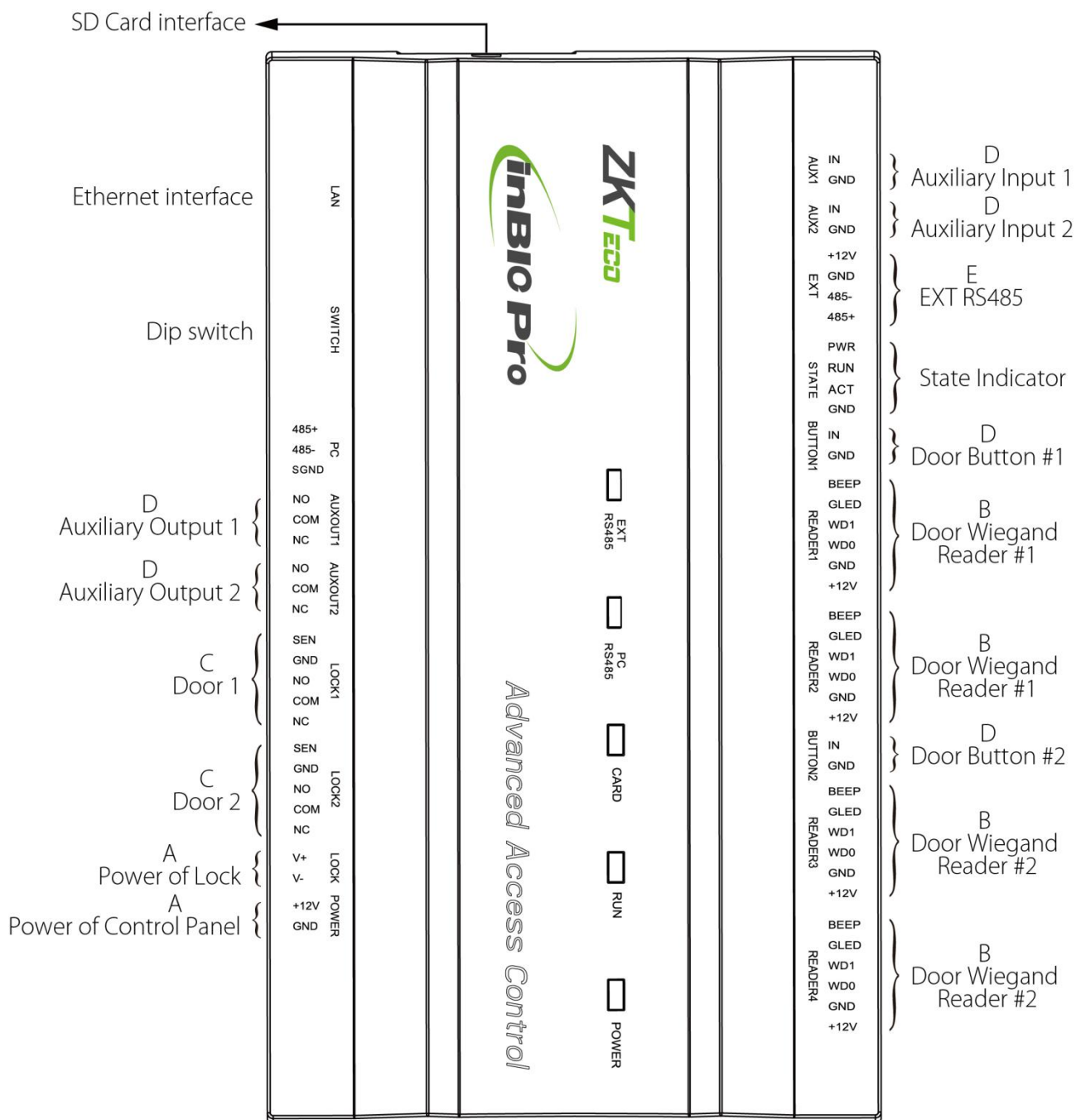

InBio460 Pro Terminal connection diagram

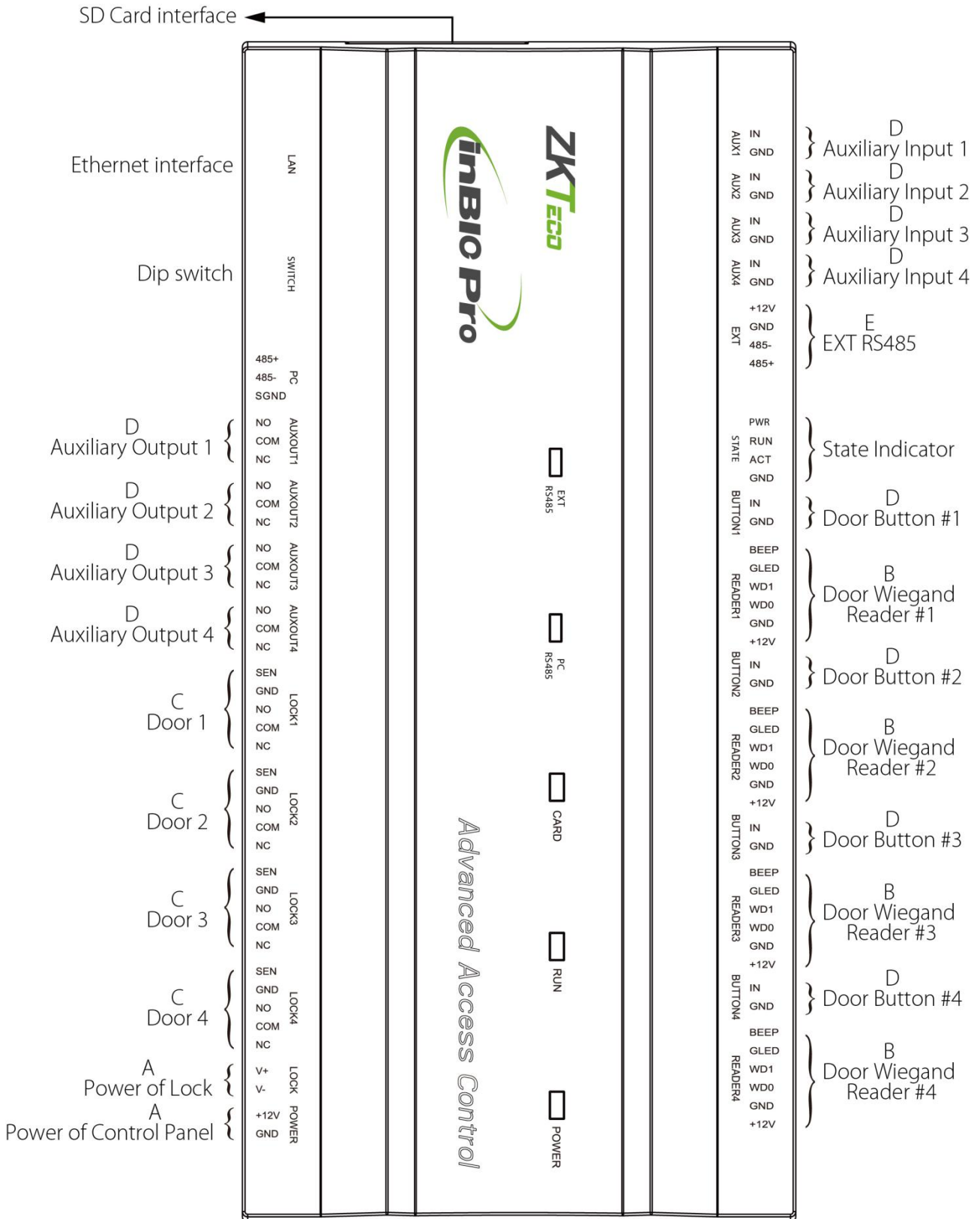

- **Description of the terminals:**

1. The auxiliary input may connect to infrared body detectors, fire alarms, or smoke detectors.
2. The auxiliary output may connect to alarms, cameras or doorbells, etc.
3. The RS485 Reader port can be connected externally to RS485 reader.
4. The terminals above are set through the relevant access control software. Please see the respective software manual for further details.

- **SD card function:**

1. Backup event records of access control for client.

- **Ports of InBio160/260/460 Pro Control Panel:**

No.	Functional Port	InBio160 Pro (One-Door Two-Way)	InBio260 Pro (Two-Door Two-Way)	InBio460 Pro (Four-Door One-Way/ Two-Door Two Way)
1	Wiegand card reader interface	2	4	4
2	Exit button	1	2	4
3	Control lock relay	1	2	4
4	Door sensor	1	2	4
5	Extension input	1	2	4
6	Extension output	1	2	4
7	RS485 & PC communication	×	×	×
8	RS485 extension communication	✓	✓	✓
9	TCP/IP	✓	✓	✓

3.5 Connection with Door Sensors, Exit Switches, Auxiliary Input Devices, and RS485 Extension Communication

1. Door sensor

A Door Sensor is used to sense the open/close status of a door. With a door sensor switch, an access control panel can detect the unauthorized opening of a door and will trigger the output of alarm.

Moreover, if a door is not closed within a specified period after it is opened, the door control panel will also raise the alarm. It is recommended to select two-core wires with a gauge over 0.22 mm². A door sensor can be omitted if it is unnecessary to monitor the open/closed status of a door, raise the alarm when the door is not closed for a long time, monitor if there is unauthorized access, and use the interlock function.

2. Exit switch

An exit switch is a switch installed indoor to open a door. When it is switched on, the door will be opened. An exit button is fixed at the height of about 1.4m above the ground. Ensure it is located in the right position without slant, and its connection is correct and secure. (Cut off the exposed end of any unused wire and wrap it with insulating tape.) Make sure to avoid electromagnetic interference (such as light switches and computers). It is recommended to use two-core wires with a gauge over 0.3mm² as the connection wire between an exit switch and the Control panel.

3. Auxiliary input

The InBio160 Pro provides one auxiliary input interface; the InBio260 Pro provides two and the InBio460 Pro provides four, which may connect to infrared body detectors, smoke detectors, gas detectors, window magnetic alarms, wireless exit switches, etc. Auxiliary inputs are set through the relevant access control software. Please see the **ZKAccess 4.0 user manual** for further details.

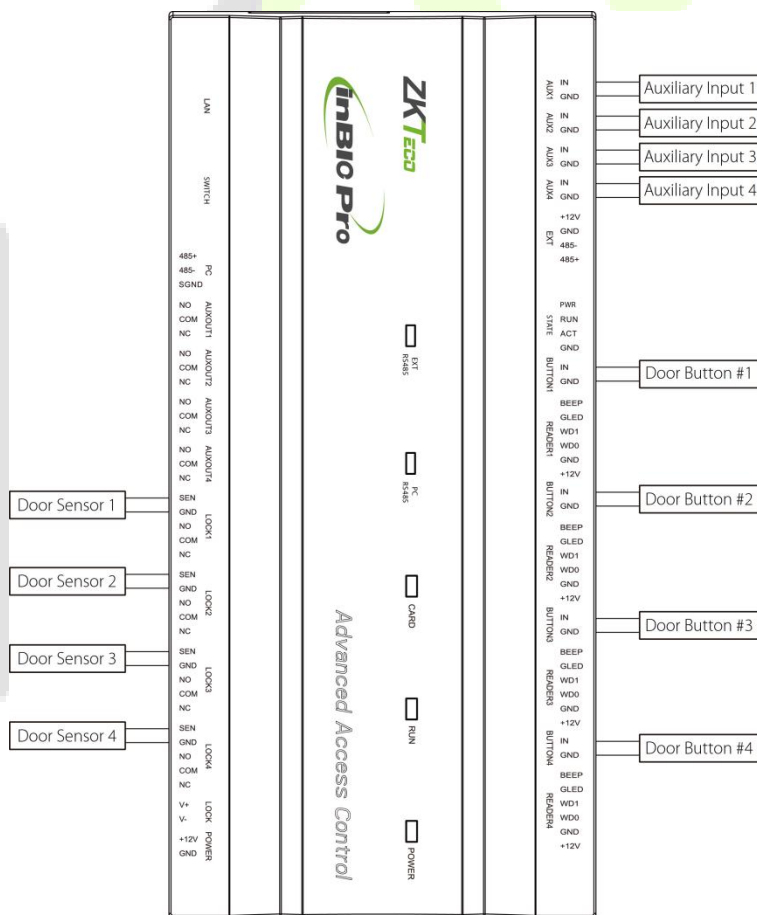

Figure 3-3 Connections between InBio460 Pro and Door Sensors, Exit Switches, and Auxiliary Input Devices

3.6 Connection with Readers

The Control panel supports RS485 reader and Wiegand reader.

- **Connection with RS485 readers**

The InBio160 Pro can connect two RS485 readers in the one-door two-way mode. The InBio260 Pro provides four readers, which can be connected in the two-door two-way mode. The InBio460 Pro provides four readers, which can be connected in the two-door two-way or four-door two-way mode.

RS485 reader connection: Set the RS485 address (device number) of the reader by DIP switch or other ways.

Control Panel \ RS485 address	1	2	3	4	5	6	7	8
InBio160 Pro	#1Door IN	#1Door OUT						
InBio260 Pro	#1Door IN	#1Door OUT	#2Door IN	#2Door OUT				
InBio460 Pro	#1Door IN	#1Door OUT	#2Door IN	#2Door OUT	#3Door IN	#3Door OUT	#4Door IN	#5Door OUT

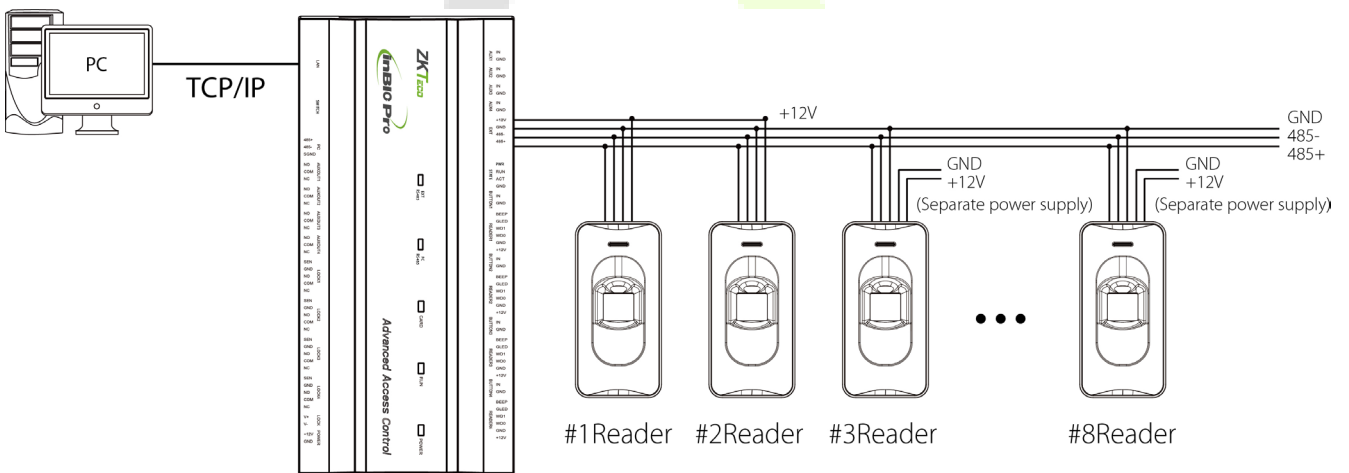

Figure 3-4 Connection between inBio460 Pro and RS485 Readers

A single EXT RS485 interface can supply for maximum 750 mA (12V) current. So the entire current consumption should be less than this max value when the readers share power with the panel. For calculation, please use max current of the reader, and starting current is usually more than twice of the normal work current, please consider this situation.

Using the KR502M-RS card reader as an example, the standby current is less than 80mA, the max current is less than 90mA. When starting the device, Instantaneous current can reach for 180 mA. For RS485 reader,

considered that the starting current is bigger, there are only four readers can connect for power supply through the EXT RS485 interface. So the power of control panel can only connect up to 4 readers.

If RS485 reader is connected externally and shares the power supply with the device, it is recommended that the connection between the EXT RS485 port and the reader be no longer than 100m. Otherwise, it is recommended that using a separate power supply for the reader.

For some of the devices with much greater consumption, we suggest to use the separately power supplies, to make sure the steady operation.

● **Connection with Wiegand Readers**

The InBio160 Pro can connect two Wiegand readers in the one-door two-way mode. The InBio260 Pro provides four readers, which can be connected in the two-door two-way mode. The InBio460 Pro provides four readers, which can be connected in the two-door two-way or four-door one-way mode.

The Wiegand interfaces provided by the InBio160/260/460 Pro series can be connected to different types of readers. If your card reader does not use the voltage of DC 12V, an external power supply is needed. A reader should be installed at a height of about 1.4m above the ground and at a distance of 30-50mm away from a door frame.

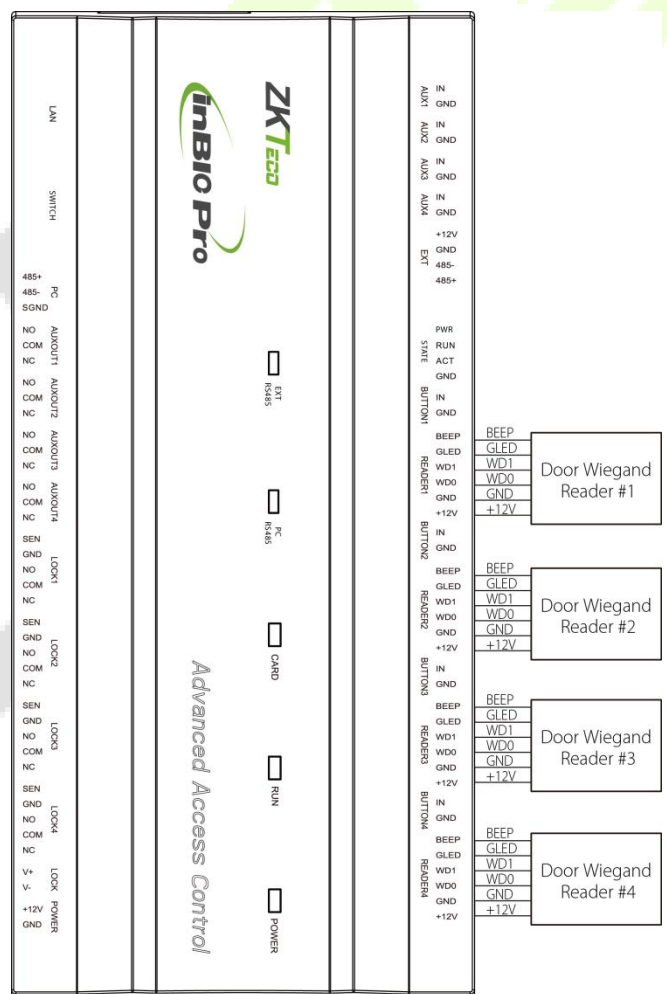



Figure 3-5 The connection between the Control Panel and Wiegand Readers

3.7 Relay Output Connection

InBio160 Pro has two relays (one used as control lock by default, and the other one used as auxiliary output); InBio260 Pro has four relays (two used as control locks by default, and the other two used as auxiliary outputs); InBio460 Pro has eight relays (four used as control locks by default, and the other four used as auxiliary outputs).

The relays for auxiliary outputs may connect to monitors, alarms, doorbells, etc. Auxiliary outputs are set through the relevant access control software. Please refer to the respective software manual for details.

1. The default connection mode of the door lock is "dry mode." In general, the electronic lock uses an external power supply separately. The wiring mode of the door lock relay cannot be changed, except that the auxiliary output relay. The diagram below uses the example of a door lock connection to demonstrate the output relay connection.
2. An access control panel provides multiple electronic lock outputs. The COM and NO terminals apply to the locks that are unlocked when power is connected and locked when power is disconnected. The COM and NC terminals use the locks that are locked when power is connected and unlocked when power is disconnected.
3. To protect the access control system against the self-induced electromotive force generated by an electronic lock at the instant of switching off/on, it is necessary to connect a diode in parallel (please use FR107 delivered with the system) with the electronic lock to release the self-induced electromotive force during the onsite connection for application of the access control system.
4. By setting the jumper terminal beside the lock relay, you can select the device power supply or lock power supply for the lock (that is, the wet mode or dry mode).

- **Dry mode jumper setting:** short 1-2 and 3-4 , and the device power supply will be used for the relay output.

- **Wet mode jumper setting:** short 2-3 and 4-5 , and the lock power supply will be used for the relay output.

Note: The default connection mode of the door lock is "Dry mode".

Take the InBio160 Pro as an example here, as shown in the following figure.

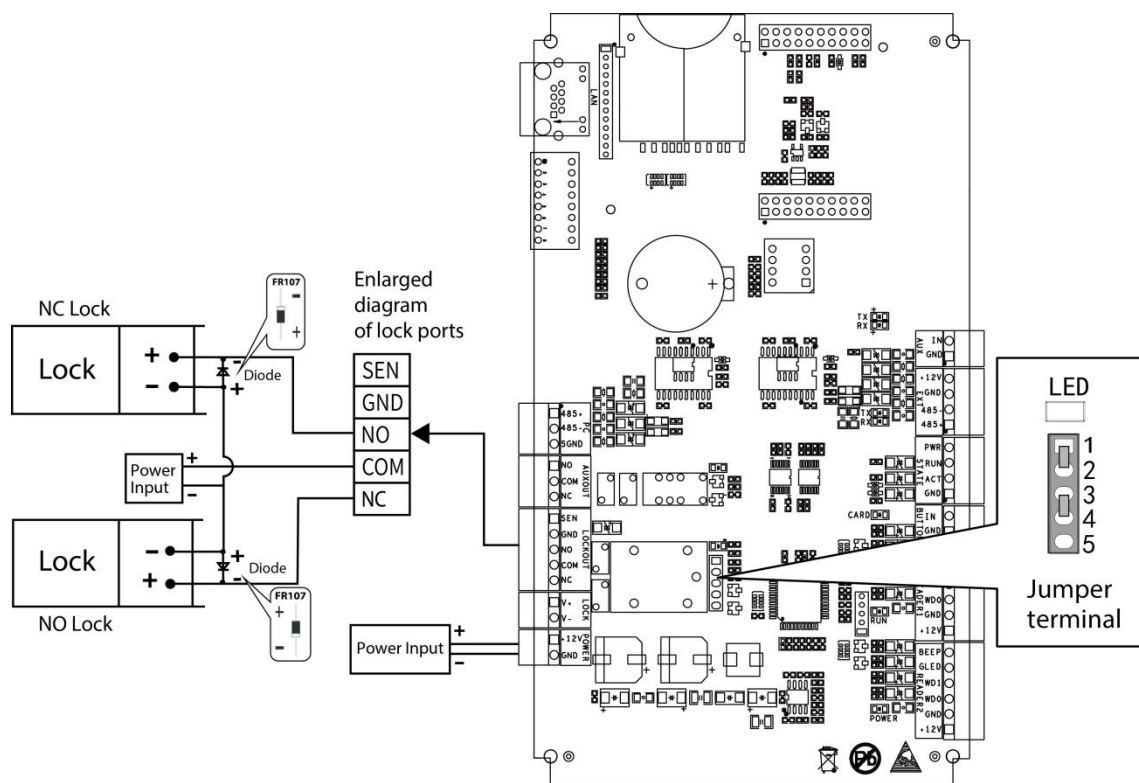

Figure 3-6 "Dry mode" wiring diagram of lock connecting with external power supply(recommend)

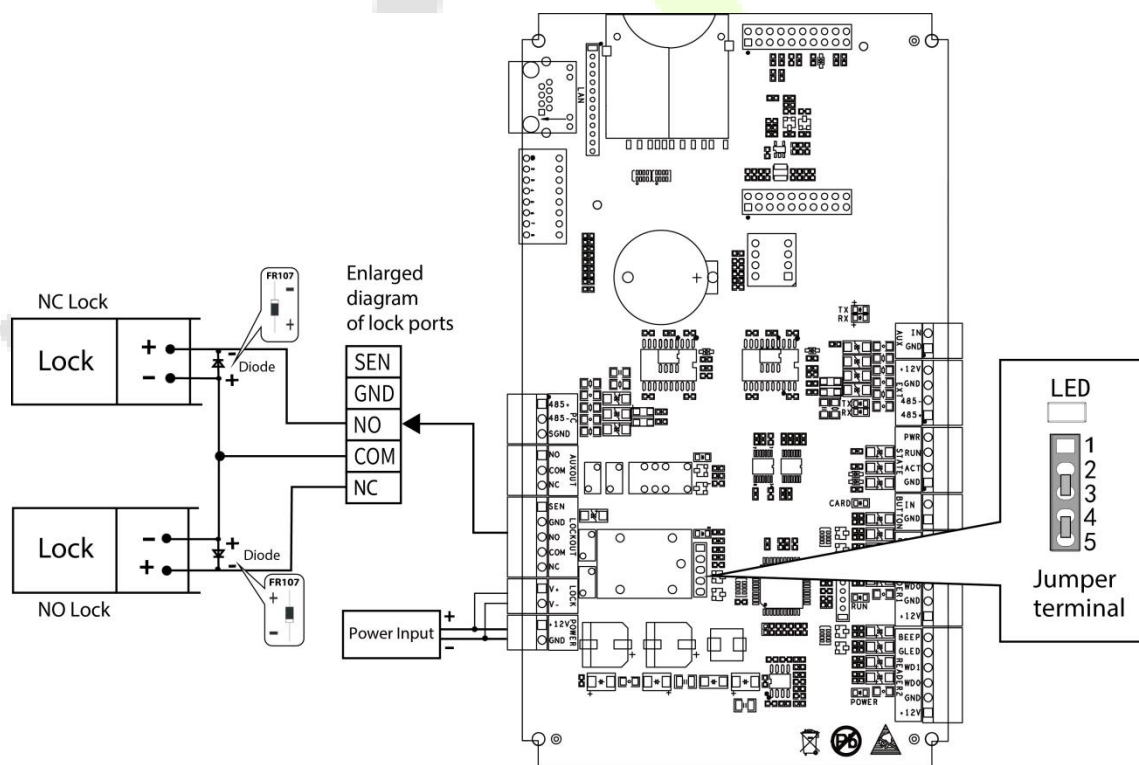
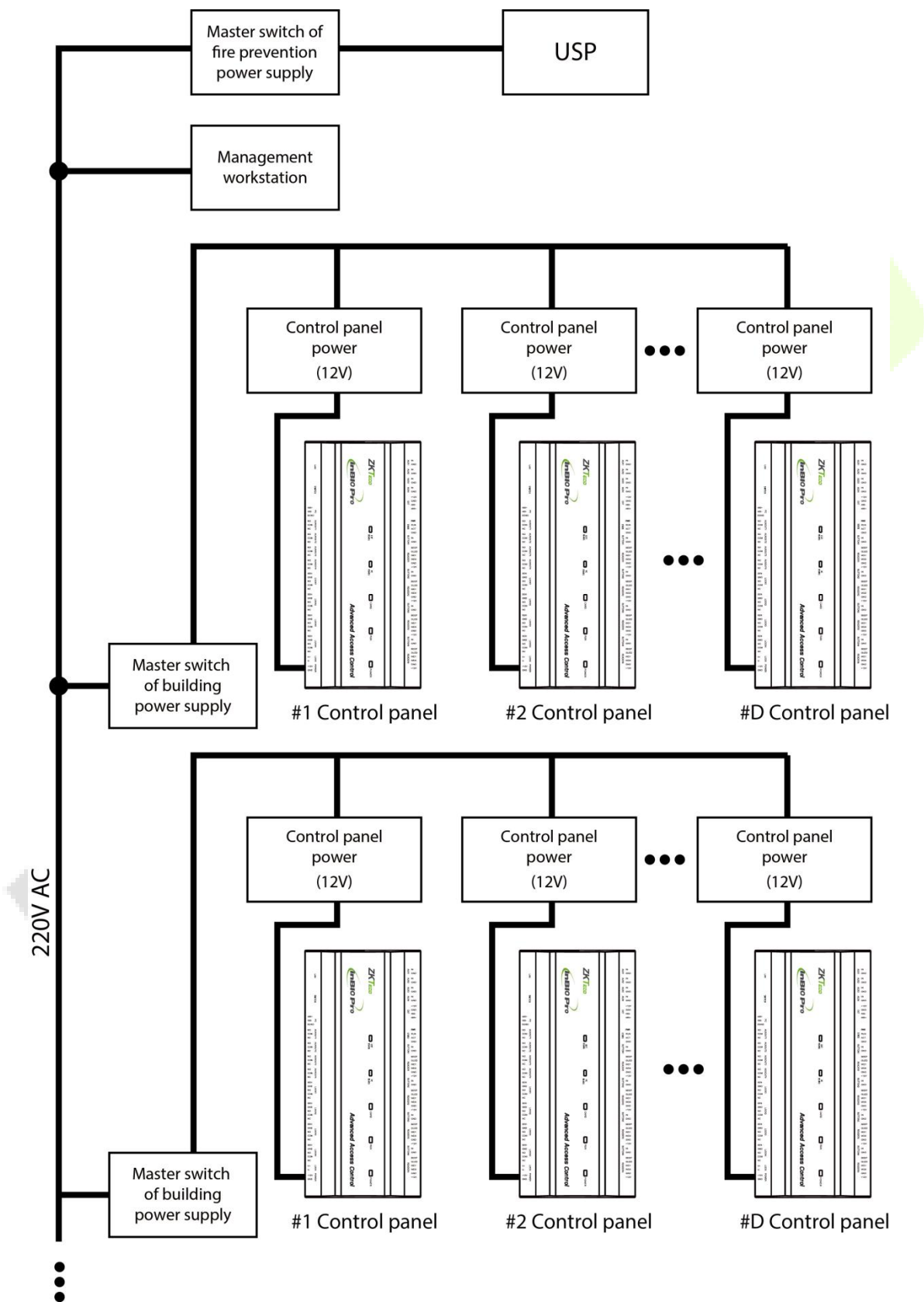

Figure 3-7 "Wet mode" wiring ports diagram of lock and controller common power supply

3.8 Access Control Operator Panel System Power Supply Structure



An access control operator panel is powered by +12V DC. Generally, to reduce power interference between control panels, each control operator panel should be powered separately. When high reliability is required, control panels and electronic locks should be powered respectively.

To prevent power failure of a control operator panel from making the whole system unable to work normally, the access control management system is usually required to have one UPS at least, and access control locks are powered externally to guarantee the access control management system can still work normally during power failure.



4 Equipment Communication

The background PC software can communicate with the system according to two protocols (TCP/IP and RS485) for data exchange and remote management.

4.1 Access Control Networking Wires and Wiring

1. The power supply is 12V DC converted from 220V.
2. As an electronic lock has a large current, it generates a strong interference signal while functioning. To reduce such an effect, 4-core wires (RVVP $4 \times 0.75\text{mm}^2$, two for a power supply, and two for a door sensor) are recommended.
3. RS485 communication wires are made of internationally accepted shielded twisted pairs, which prove effective to prevent and shield interference.
4. The Wiegand readers use 6-core communication shielded wires (RVVP $6 \times 0.5\text{mm}$) (usually there are 6-core, 8-core, and 10-core types available for users to select according to the ports) to reduce interference during transmission.
5. Other control cables (like exit switches) are all made of 2-core wires (RVVSP $2 \times 0.5\text{mm}^2$).
6. Notes for wiring:
 - Signal wires (like network cables) can neither run in parallel with nor share one casing pipe with large-power electric wires (like electronic lock wires and power cables). If parallel wiring is unavoidable for environmental reasons, the distance must be above 50cm.
 - Try to avoid using any conductor with a connector during distribution. When a connector is indispensable, it must be crimped or welded. No mechanical force can be applied to the joint or branch of conductors.
 - In a building, the distribution lines must be installed horizontally or vertically. They should be protected in casing pipes (like plastic or iron water pipes, to be selected according to the technical requirements of the indoor distribution). Metal hoses are applicable to ceiling wiring, but they must be secure and good-looking.
 - Shielding measures and shielding connection: If the electromagnetic interference in the wiring environment is found substantial in the survey before construction, it is necessary to consider the shielding protection of data cables when designing a construction scheme. Overall, shielding protection is required if there is a large radioactive interference source or wiring has to be parallel with a large-current power supply on the construction site. Generally, shielding measures includes keeping a maximum distance from any interference source, and using metal wiring troughs or galvanized metal water pipes to ensure reliable grounding of the connection between the shielding layers of data cables and the metal troughs or pipes. Noted that a shielding enclosure can have a shielding effect only when it is grounded reliably.

- Ground wire connection method: Reliable large-diameter ground wires in compliance with applicable national standards are needed on the wiring site and should be connected in a tree form to avoid DC loop. These ground wires must be kept far away from lightning fields. No lightning conductor can serve as a ground wire and ensure there is no lightning current through any ground wire when there is lightning. Metal wiring troughs and pipes must be connected continuously and reliably and linked to ground wires through large-diameter cables. The impedance of this section of wire cannot exceed 2 ohms. Also, the shielding layer must be connected reliably and grounded at one end to guarantee a uniform current direction. The ground wire of the shielding layer must be connected through a large-diameter wire (not less than 2.5mm²).

4.2 TCP/IP Communication

The Ethernet 10/100Base-T Crossover Cable, a type of crossover network cable, is mainly used for cascading hubs and switches or used to connect two Ethernet endpoints directly (without a hub). Both 10Base-T and 100Base-T are supported.

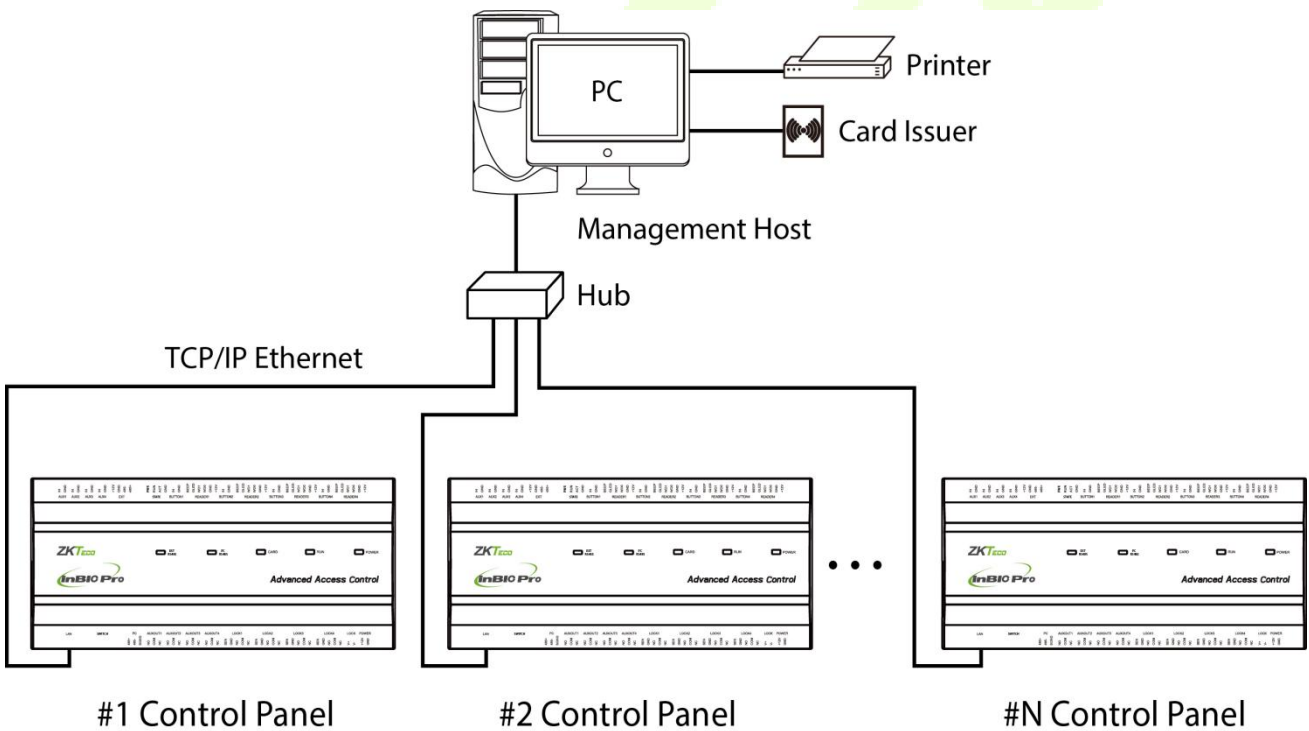

Figure 4-1 TCP/IP Communication System Networking

In Access software: Click **Device > Search Device** to search for access controllers in the network, and directly add from the search result.

4.3 RS485 Communication

1. RS485 communication wires are made of internationally accepted RVSP wires (shielded twisted pairs), which prove effective to prevent and shield interference. RS485 communication wires should be

connected by means of bus cascade instead of in a star form, to achieve a better shielding effect by reducing signal reflection during communications.

2. A single 485 bus can be connected with 63 access control operator panels at most, but preferably should be connected with less than 32.
3. To eliminate signal attenuation in communication cables and suppress interference, if the bus is longer than 300 meters, one 120ohm resistance is usually inserted between the first and last access control operator panels on the RS485 bus.
4. For this access control operator panel, putting place 8 of the DIP switch to the ON position is equivalent to parallel connection of one 120ohm resistance between the 485+ and 485- lines. As shown in the figure below, put place 8 of the DIP switches of the first and last control operator panels

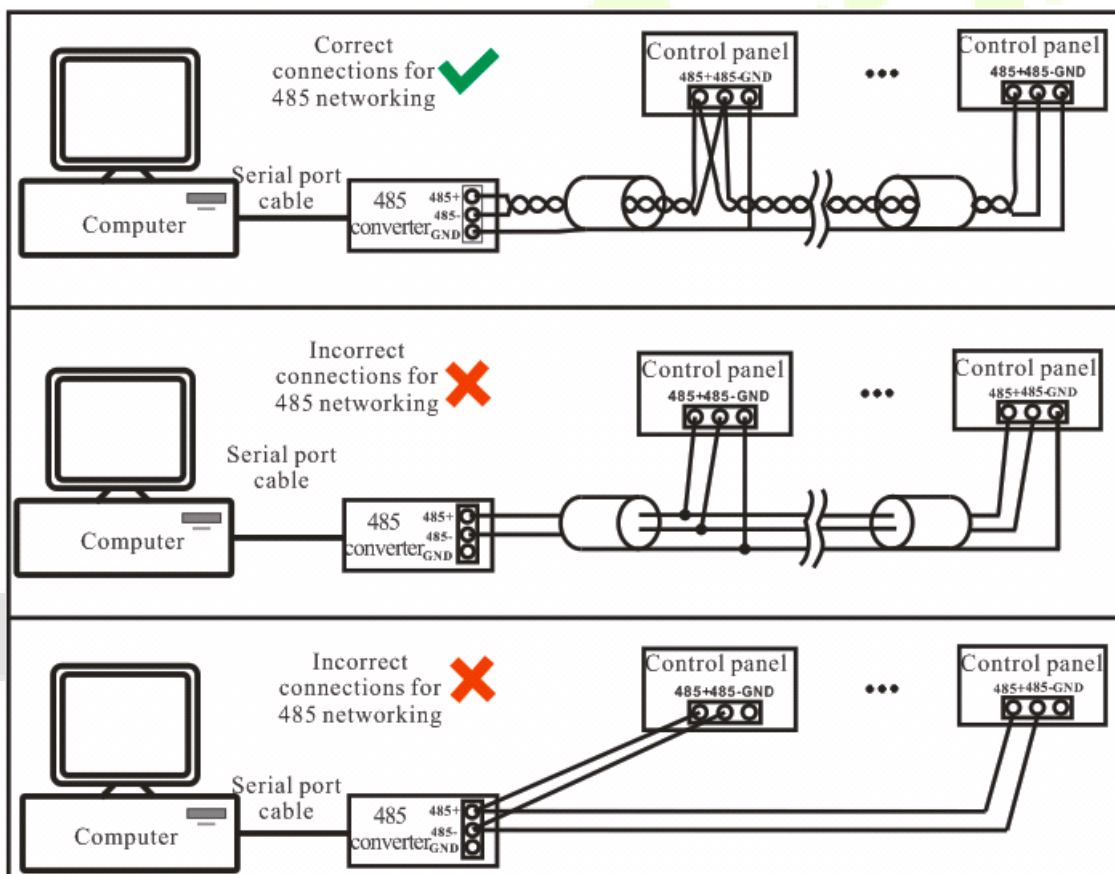

Figure 4-2 RS485 Communication System Networking

4.4 DIP Switch Settings

This part introduces how to set the RS485 address setting, factory setting and terminal resistance setting of the control panel through the DIP switch.

● **485 address setting**

Places 1-6 of the DIP switch are reserved to set device number for RS485 communication. The code is binary, and the lower places are in the front. When the switch is set to the **ON** position, it indicates 1 (on); when the switch is set downwards, it indicates 0 (off).

For example, to set a device number 39=1+2+4+32, which corresponds to the binary code 111001, put places 1, 2, 3, and 6 to the **ON** position, as illustrated below.



485 address setting table:

Place Address	Switch Setting					
	1	2	3	4	5	6
Address No.	1	2	4	8	16	32
01	ON	OFF	OFF	OFF	OFF	OFF
02	OFF	ON	OFF	OFF	OFF	OFF
03	ON	ON	OFF	OFF	OFF	OFF
04	OFF	OFF	ON	OFF	OFF	OFF
05	ON	OFF	ON	OFF	OFF	OFF
06	OFF	ON	ON	OFF	OFF	OFF
07	ON	ON	ON	OFF	OFF	OFF
08	OFF	OFF	OFF	ON	OFF	OFF
09	ON	OFF	OFF	ON	OFF	OFF
10	OFF	ON	OFF	ON	OFF	OFF
11	ON	ON	OFF	ON	OFF	OFF
12	OFF	OFF	ON	ON	OFF	OFF
13	ON	OFF	ON	ON	OFF	OFF
14	OFF	ON	ON	ON	OFF	OFF
15	ON	ON	ON	ON	OFF	OFF
16	OFF	OFF	OFF	OFF	ON	OFF
17	ON	OFF	OFF	OFF	ON	OFF
18	OFF	ON	OFF	OFF	ON	OFF
19	ON	ON	OFF	OFF	ON	OFF
20	OFF	OFF	ON	OFF	ON	OFF
21	ON	OFF	ON	OFF	ON	OFF
22	OFF	ON	ON	OFF	ON	OFF
23	ON	ON	ON	OFF	ON	OFF
24	OFF	OFF	OFF	ON	ON	OFF
25	ON	OFF	OFF	ON	ON	OFF
26	OFF	ON	OFF	ON	ON	OFF
27	ON	ON	OFF	ON	ON	OFF

Place Address	Switch Setting					
	1	2	3	4	5	6
28	OFF	OFF	ON	ON	ON	OFF
29	ON	OFF	ON	ON	ON	OFF
30	OFF	ON	ON	ON	ON	OFF
31	ON	ON	ON	ON	ON	OFF
32	OFF	OFF	OFF	OFF	OFF	ON
33	ON	OFF	OFF	OFF	OFF	ON
34	OFF	ON	OFF	OFF	OFF	ON
35	ON	ON	OFF	OFF	OFF	ON
36	OFF	OFF	ON	OFF	OFF	ON
37	ON	OFF	ON	OFF	OFF	ON
38	OFF	ON	ON	OFF	OFF	ON
39	ON	ON	ON	OFF	OFF	ON
40	OFF	OFF	OFF	ON	OFF	ON
41	ON	OFF	OFF	ON	OFF	ON
42	OFF	ON	OFF	ON	OFF	ON
43	ON	ON	OFF	ON	OFF	ON
44	OFF	OFF	ON	ON	OFF	ON
45	ON	OFF	ON	ON	OFF	ON
46	OFF	ON	ON	ON	OFF	ON
47	ON	ON	ON	ON	OFF	ON
48	OFF	OFF	OFF	OFF	ON	ON
49	ON	OFF	OFF	OFF	ON	ON
50	OFF	ON	OFF	OFF	ON	ON
51	ON	ON	OFF	OFF	ON	ON
52	OFF	OFF	ON	OFF	ON	ON
53	ON	OFF	ON	OFF	ON	ON
54	OFF	ON	ON	OFF	ON	ON
55	ON	ON	ON	OFF	ON	ON
56	OFF	OFF	OFF	ON	ON	ON
57	ON	OFF	OFF	ON	ON	ON
58	OFF	ON	OFF	ON	ON	ON
59	ON	ON	OFF	ON	ON	ON
60	OFF	OFF	ON	ON	ON	ON
61	ON	OFF	ON	ON	ON	ON
62	OFF	ON	ON	ON	ON	ON
63	ON	ON	ON	ON	ON	ON

● **Restoring factory setting**

The silk-screened **7** (place 7) of the DIP switch is the switch for restoration of system settings. The place is set to **OFF** by default. When place 7 is moved upwards and downwards for three times within 10 seconds

and finally returned to the **OFF** position, the factory settings will be restored after the access control operator panel is restarted.

- **Terminal resistance setting**

Place 8 is for setting the RS485 termination resistance. Putting the switch to the **ON** position is equivalent to parallel connection of a 120ohm termination resistance between 485+ and 485-.

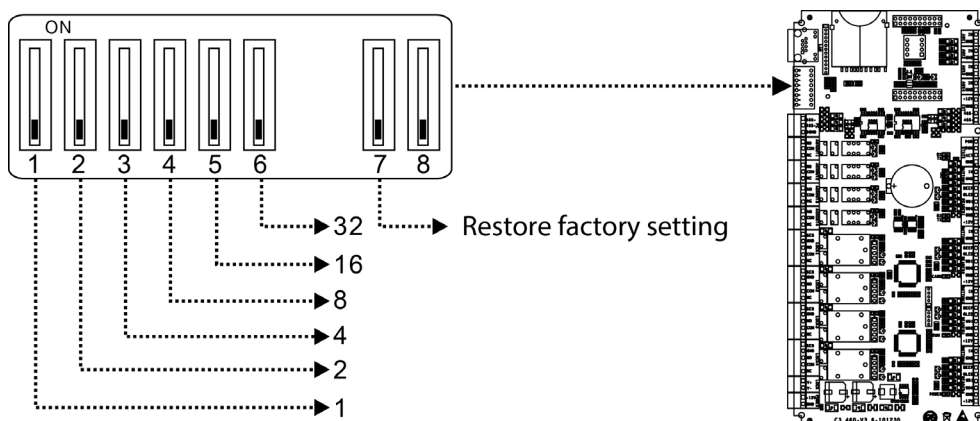

4.5 ZKPanelWeb

To help users conveniently manage controllers, the built-in Web Server function is added to some models. With this function, a user can connect to the controller through a PC, and enter the IP address of the controller to access the web. Users can also use the Web Server function to perform other operations, such as network configuration, Push communication configuration, time synchronization, and user account management.

- **Log on to the Web Server**

- Connect the controller to the network or PC, start the browser, enter the IP address of the controller, which is 192.168.1.201 by default. Then you can visit the Web Server.

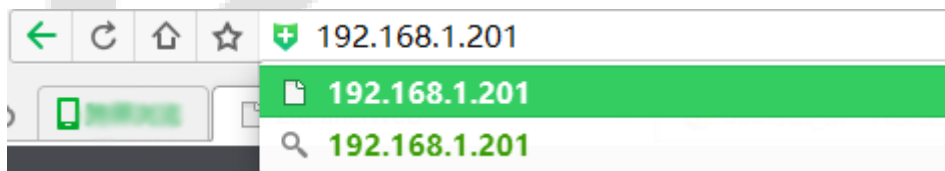

- When Web Server is used, "User Name" and "Password" should be set firstly. The default "user name" and "password" are **admin**.

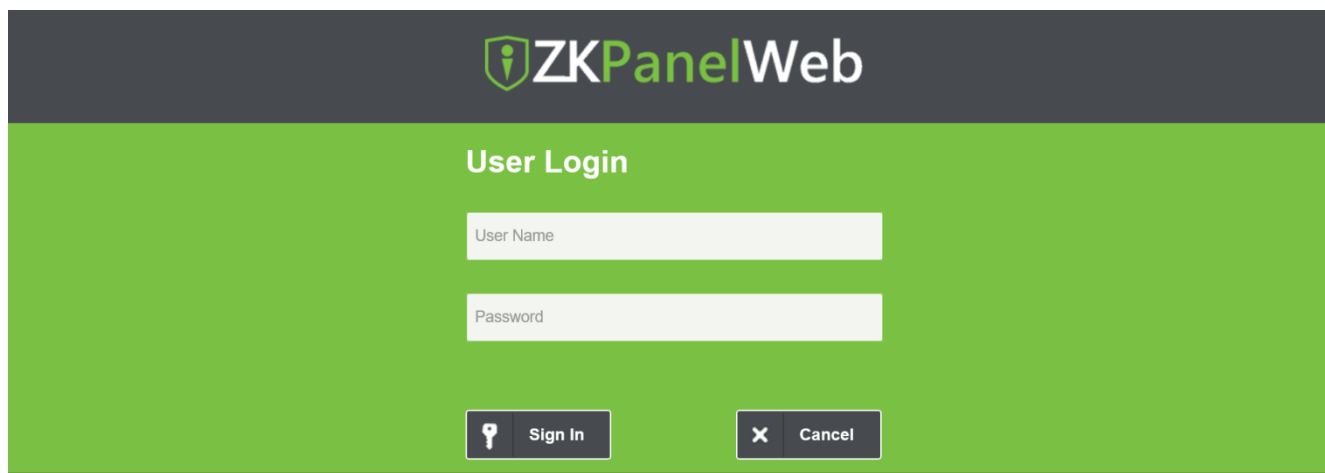

c. Click **Sign In** to access the ZKPanelWeb.

Note:

- 1) IP addresses of both the server (PC) and the controller must be in the same network segment.
- 2) IP address of the controller could be found by searching devices with the BioSecurity software ([**Access - Access Device - Device - Search Device**]).

- **Basic Operation Bar of the Web Server**



1. **Change of the Administrator's Password**

a. Click . The following page is displayed:

Modify Password		Close
User Name:	<input type="text" value="admin"/>	
Old Password:	<input type="password"/>	* Enter a string of 4-30 characters!
New Password:	<input type="password"/>	* Enter a string of 4-30 characters!
Confirm New Password:	<input type="password"/>	* Enter a string of 4-30 characters!
<input type="button" value="Confirm"/> <input type="button" value="Cancel"/>		

b. Enter the old and new passwords, and click Confirm to change the administrator's login password.

2. **Language Settings**

Click , change the language in which the server interface is displayed, and click **Confirm**.

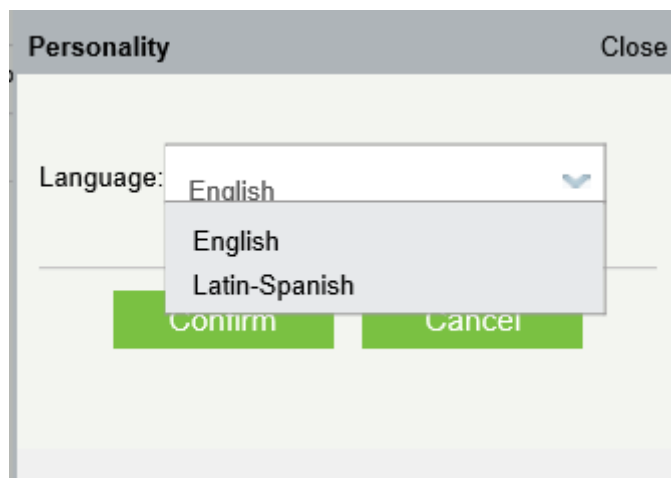

3. Use Conditions of the Server

Click , and you can view the version of the current server, as well as the browser and resolution recommended for the server.

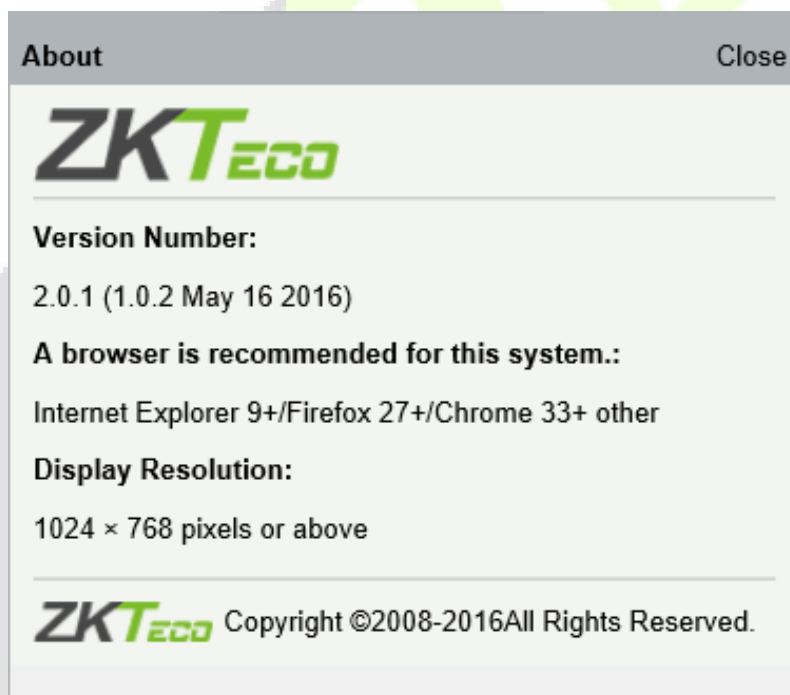

4. Online Help of the Server

If you met some problems when using the server, click  to view or download the user help document.

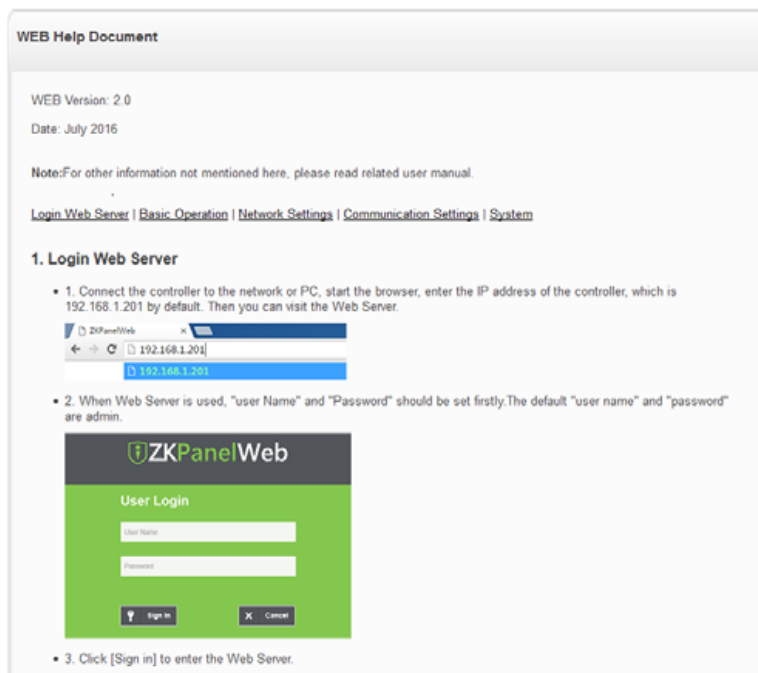

5. **Exit**

Click , and then click **Confirm** to return to the server login page.

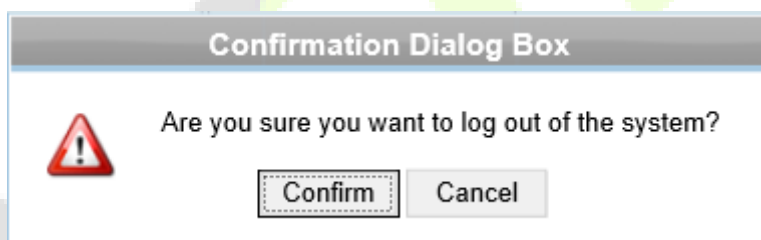

● **Network Settings**

1. **TCP/IP Settings**

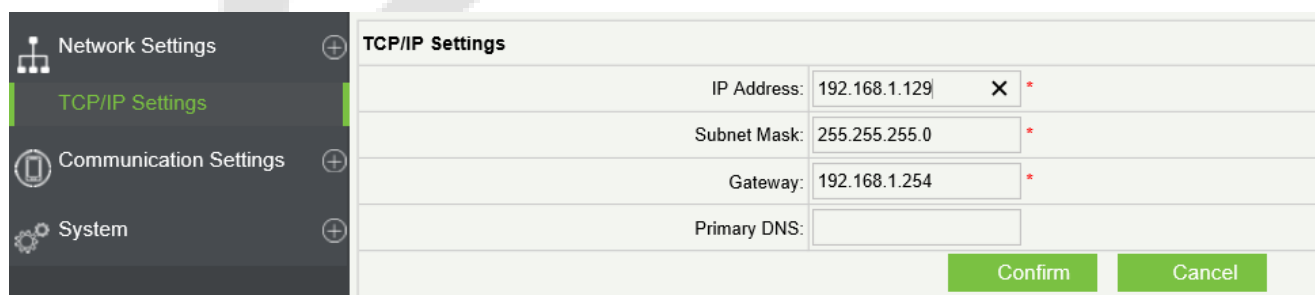

Function introduction:

Set the TCP/IP communication parameters, which are used in the communications between device and PC.

Operating steps:

- a. Click **Network Setting > TCP/IP Settings**.
- b. Input the device’s IP address, Subnet Mask, Default Gateway.
 - **IP address:** the default IP is **192.168.1.201**, and you can modify according to the actual.
 - **Subnet Mask:** the default subnet mask is 255.255.255.0, and you can modify according to the actual.
 - **Default Gateway:** the default gateway is 0.0.0.0, and you can modify it according to the actual.
 - **Primary DNS:** the default value is null, and you can set its value.
- c. Click **Confirm** to write parameters into the device. please restart the device by manual.

- **Communication Settings**

1. PUSH Server Settings

- **PUSH Server:** Indicates that the controller proactively pushes information to the server.
- **IP Mode:** the default server IP is 0.0.0.0, and you can modify it according to the actual.
- **Port:** the default Port is **80**, and you can modify it according to the actual.

- **Domain Mode:** the default value is null, and you can set its value.

2. Port Settings

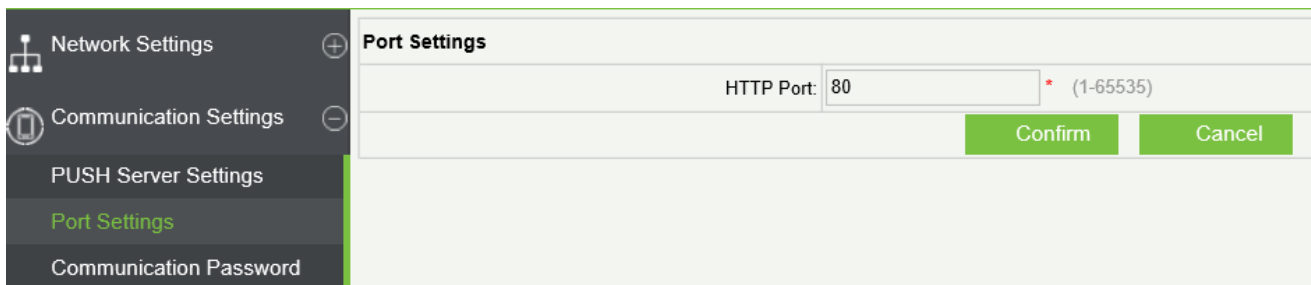

- **Http Port:** Indicates that the client initiates an HTTP request to a specified port on the server. the default HTTP Port is 80, and you can modify it according to the actual.

3. Communication Password

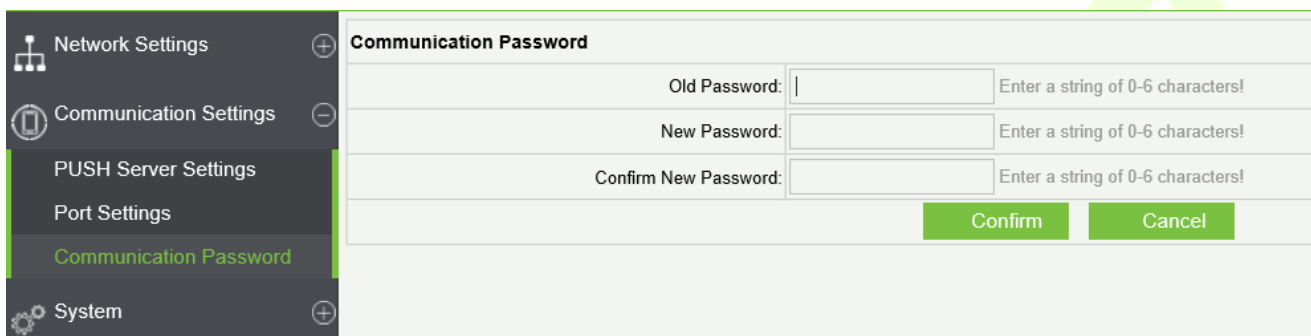

Communication Password: Indicates that network communication is encrypted. The default value is null, and you can set its value.

If you configure the communication password here, the same communication password must be configured on the server before the connection can be set up.

- **System**

1. User Settings

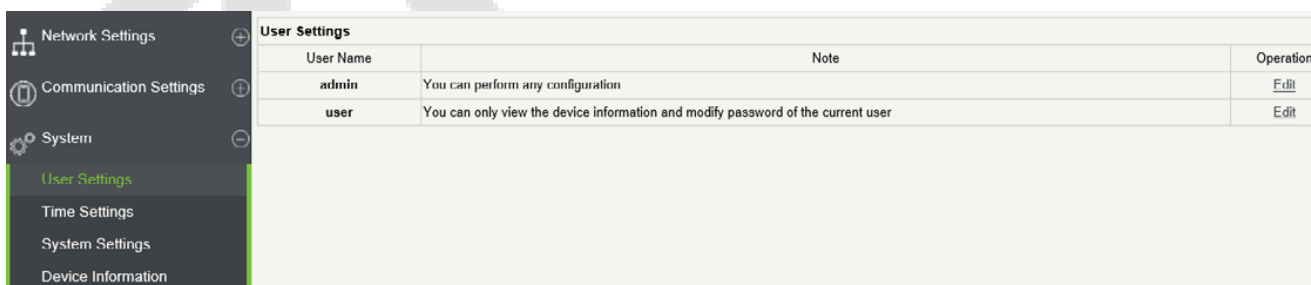

Click **Edit** to change the login password of an administrator or a user.

2. Time Settings

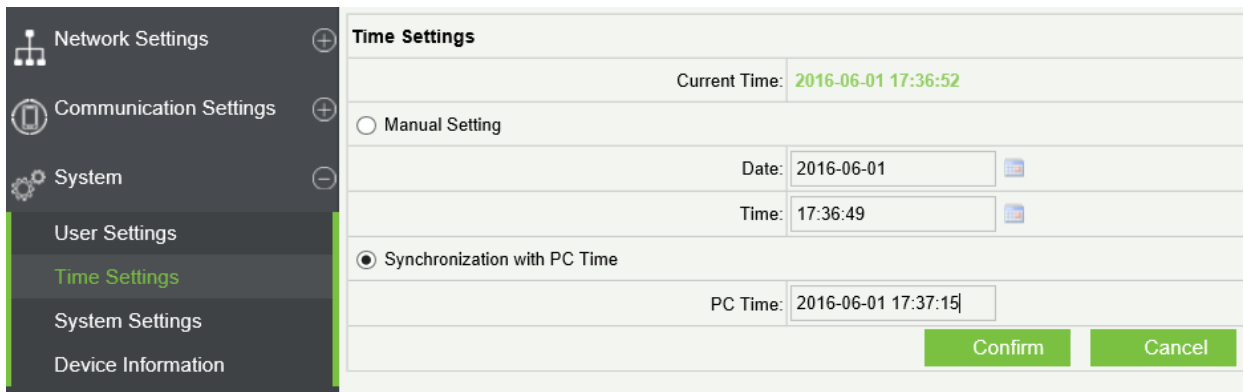

You can manually configure the controller time or synchronize the controller time with the PC time, and click Confirm to complete the setting.

3. System Settings

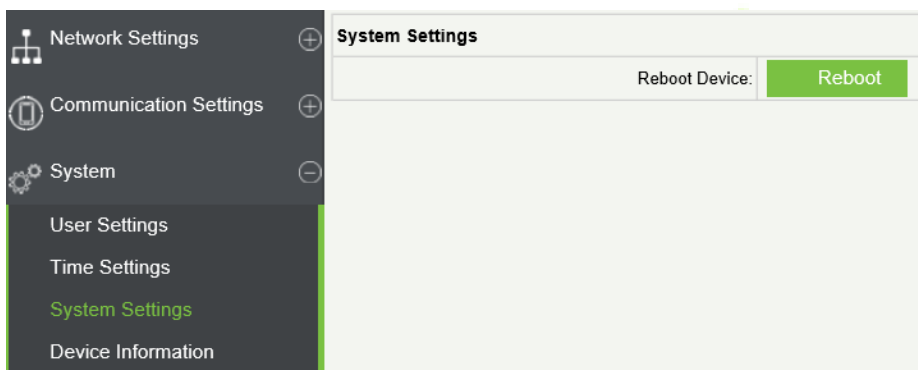

Click **Reboot**. The device will be restarted.

4. Device Information

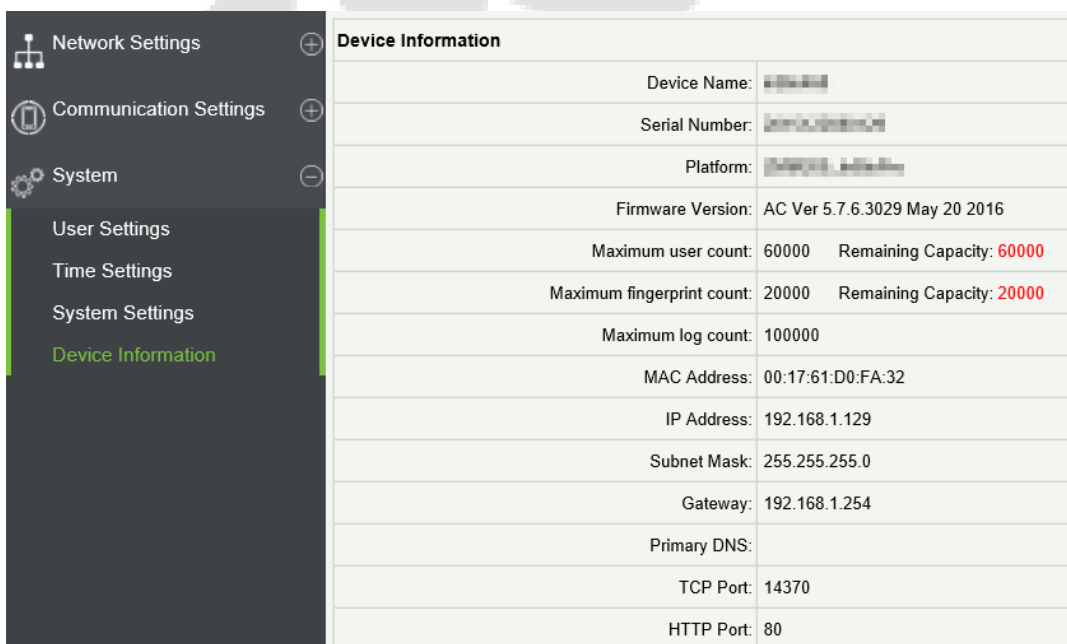

5 Statement on the Right to Privacy

Dear Customers,

Thank you for choosing this hybrid biometric recognition product, which was designed and manufactured by ZKTeco. As a world-renowned provider of core biometric recognition technologies, we are constantly developing and researching new products, and strive to follow the privacy laws of each country in which our products are sold.

We Declare That

1. All our civilian fingerprint recognition devices capture only characteristics, not fingerprint images, and do not involve privacy protection.
2. None of the fingerprint characteristics that we capture can be used to reconstruct an image of the original fingerprint and do not involve privacy protection.
3. As the provider of this device, we will assume no direct or indirect responsibility for any consequences that may result from your use of this device.
4. If you would like to dispute human rights or privacy issues concerning your use of our product, please directly contact your dealer.

Our other law-enforcement fingerprint devices or development tools can capture the original images of citizen's fingerprints. As to whether or not this constitutes an infringement of your rights, please contact your Government or the final supplier of the device. As the manufacturer of the device, we will assume no legal liability.

Note:

The Chinese law includes the following provisions on the personal freedom of its citizens:

1. There shall be no illegal arrest, detention, search, or infringement of persons.
2. Personal dignity is related to personal freedom and shall not be infringed upon.
3. A citizen's house may not be infringed upon.
4. A citizen's right to communication and the confidentiality of that communication is protected by the law.

As a final point, we would like to further emphasize that biometric recognition is an advanced technology that will be certainly used in E-commerce, banking, insurance, judicial, and other sectors in the future. Every year the world is subjected to major losses due to the insecure nature of passwords. The Biometric products serve to protect your identity in high-security environments.

6 Eco-friendly Operation



The product's "eco-friendly operational period" refers to the time period during which this product will not discharge any toxic or hazardous substances when used in accordance with the prerequisites in this manual.

The eco-friendly operational period specified for this product does not include batteries or other components that are easily worn down, and must be periodically replaced. The battery's eco-friendly operational period is 5 years.

Hazardous or Toxic substances and their quantities

Component Name	Hazardous/Toxic Substance/Element					
	Lead (Pb)	Mercury (Hg)	Cadmium (Cd)	Hexavalent chromium (Cr6+)	Polybrominated Biphenyls (PBB)	Polybrominated Diphenyl Ethers (PBDE)
Chip Resistor	×	○	○	○	○	○
Chip Capacitor	×	○	○	○	○	○
Chip Inductor	×	○	○	○	○	○
Diode	×	○	○	○	○	○
ESD component	×	○	○	○	○	○
Buzzer	×	○	○	○	○	○
Adapter	×	○	○	○	○	○
Screws	○	○	○	×	○	○

○ indicates that the total amount of toxic content in all the homogeneous materials is below the limit as specified in SJ/T 11363—2006.

×

× indicates that the total amount of toxic content in all the homogeneous materials exceeds the limit as specified in SJ/T 11363—2006.

Note: 80% of this product's components are manufactured using non-toxic and eco-friendly materials. The components which contain toxins or harmful elements are included due to the current economic or technical limitations which prevent their replacement with non-toxic materials or elements.

ZKTeco Industrial Park, No. 26, 188 Industrial Road,
Tangxia Town, Dongguan, China.
Phone : +86 769 - 82109991
Fax : +86 755 - 89602394
www.zkteco.com

