



Bosch Video Management System



BOSCH

en Configuration Manual

Table of contents

1	Using the Help	16
1.1	Finding information	16
1.2	Printing the Help	16
2	Introduction	18
3	System overview	21
3.1	Hardware requirements	21
3.2	Software requirements	22
3.3	License requirements	22
4	Concepts	23
4.1	Recording settings	23
4.1.1	Basic stream settings (schedule-independent)	23
4.1.2	Stream assignment for Live	23
4.1.3	Scheduled Recording Settings	23
4.2	Config Wizard	26
4.3	Enterprise System	26
4.3.1	Scenarios	27
4.3.2	Permissions	30
4.3.3	Types of user groups	31
4.3.4	Licensing	31
4.4	Unmanaged site	31
4.4.1	Structure of CSV file for importing unmanaged sites	32
4.5	Server Lookup	33
4.5.1	Server List	35
4.6	Remote access	35
4.7	iSCSI storage pool	38
4.8	Automated Network Replenishment (ANR)	39
4.9	Dual / failover recording	40
4.10	VRM recording modes	41
4.11	Playback of VRM recording sources	44
4.12	Alarm handling	51
4.13	DVR devices	53
4.14	Mobile Video Service	54
4.15	Adding Video IP devices from Bosch	54
4.16	Region of Interest (ROI)	55
4.17	Intelligent Tracking	55
4.18	Inactivity logoff	56
4.19	Malfunction relay	56
4.20	Text data	57
4.21	Allegiant CCL commands	58
4.22	Offline Operator Client	58
4.22.1	Working with Offline Mode	58
4.23	Version independent Operator Client	61
4.23.1	Working with Compatibility Mode	61
4.24	ONVIF events	61
4.25	Viewing modes of a panoramic camera	62
4.25.1	360° panoramic camera - floor- or ceiling mounted	63
4.25.2	180° panoramic camera - floor- or ceiling mounted	64
4.25.3	360° panoramic camera - wall mounted	65

4.25.4	180° panoramic camera - wall mounted	66
4.25.5	Cropped view on a panoramic camera	67
4.26	Server-based analytics	68
4.26.1	Installing the analytics viewer application	69
4.27	Verification of authenticity	69
5	Supported hardware	71
5.1	Installing hardware	72
5.2	Installing a KBD Universal XF keyboard	72
5.3	Connecting a Bosch IntuiKey keyboard to Bosch VMS	73
5.3.1	Scenarios for Bosch IntuiKey keyboard connections	73
5.3.2	Connecting a Bosch IntuiKey keyboard to a decoder	74
5.3.3	Updating Bosch IntuiKey keyboard firmware	75
5.4	Connecting Bosch Allegiant Matrix to Bosch Video Management System	76
5.4.1	Bosch Allegiant Connection Overview	76
5.4.2	Configuring the control channel	78
5.4.3	Bosch Allegiant Satellite System Concept	80
5.5	Allegiant CCL commands supported in Bosch VMS	80
6	Getting started	83
6.1	Installing the software modules	83
6.2	Scanning for devices	83
6.3	Using Config Wizard	87
6.4	Accessing the system	97
6.5	Using Server Lookup	98
6.6	Configuring remote access	98
6.6.1	Configuring without Enterprise System	98
6.6.2	Configuring with Enterprise System	98
6.7	Activating the software licenses	99
6.8	Starting Configuration Client	100
6.9	Configuring the language of Configuration Client	100
6.10	Configuring the language of Operator Client	100
6.11	Adding a new license	100
6.12	Maintaining Bosch VMS	101
6.13	Replacing a device	102
6.13.1	Replacing a MS / EMS	102
6.13.2	Replacing a VRM	103
6.13.3	Replacing an encoder or decoder	104
6.13.4	Replacing an Operator Client	107
6.13.5	Final tests	107
6.13.6	Recovering Divar IP 3000/7000	107
6.14	Configuring time synchronization	107
6.15	Configuring the storage media of an encoder	107
6.16	Creating an Enterprise System	108
6.16.1	Configuring the Server List for Enterprise System	109
6.16.2	Creating an Enterprise User Group	110
6.16.3	Creating an Enterprise Account	111
6.17	Configuring the mounting position of a panoramic camera	112
7	Creating an Enterprise System	114
7.1	Configuring the Server List for Enterprise System	114
7.2	Creating an Enterprise User Group	116

7.3	Creating an Enterprise Account	116
8	Configuring the Server List for Enterprise System	119
9	Configuring Server Lookup	121
9.1	Exporting the Server List	122
9.2	Importing a Server List	122
10	Adding an unmanaged site	123
10.1	Importing unmanaged sites	123
10.2	Configuring the time zone	124
11	Managing VRM storage	125
11.1	Synchronizing Bosch VMS configuration	125
11.2	Scanning for VRM devices	125
11.3	Adding a Primary VRM manually	126
11.4	Adding a Secondary VRM manually	126
11.5	Adding a Mirrored VRM manually	127
11.6	Adding a Failover VRM manually	127
11.7	Adding a VRM pool	128
11.8	Adding an iSCSI device	128
11.9	Configuring automatic recording mode on a pool	128
11.10	Adding a DSA E-Series iSCSI device	129
11.11	Configuring an iSCSI device	130
11.12	Moving an iSCSI system to another pool	131
11.13	Adding a LUN	132
11.14	Formatting a LUN	133
11.15	Changing the password of a VRM device	133
11.16	Configuring dual recording in the Device Tree	133
12	Managing encoders / decoders	135
12.1	Adding an encoder to a VRM pool	135
12.2	Moving an encoder to another pool	136
12.3	Adding a live only encoder	136
12.4	Adding a local storage encoder	137
12.5	Configuring an encoder / decoder	138
12.6	Updating the device capabilities	138
12.7	Configuring failover recording mode on an encoder	139
12.8	Configuring multiple encoders / decoders	140
12.9	Changing the password of an encoder / decoder	140
12.10	Providing the destination password for a decoder	141
12.11	Configuring the storage media of an encoder	142
12.12	Adding and removing an ONVIF profile	142
12.13	Configuring ONVIF events	143
12.14	Importing an ONVIF Mapping Table file	144
12.15	Exporting an ONVIF Mapping Table file	145
12.16	Encrypting live video	145
12.17	Managing the verification of authenticity	146
12.17.1	Configuring the authentication	146
12.17.2	Downloading a certificate	146
12.17.3	Installing a certificate on a workstation	147
13	Managing Video Streaming Gateway	148
13.1	Adding a Video Streaming Gateway device	148
13.2	Moving a VSG to another pool	149

13.3	Adding a camera to a VSG	149
13.4	Configuring multicast	150
13.5	Configuring logging	150
13.6	Adding and removing an ONVIF profile	151
13.7	Assigning an ONVIF profile	151
13.8	Configuring ONVIF events	152
13.9	Importing an ONVIF Mapping Table file	153
13.10	Exporting an ONVIF Mapping Table file	153
14	Managing various devices	155
14.1	Adding a device manually	155
14.2	Adding a VIDOS NVR	159
14.3	Configuring a decoder for use with a Bosch IntuiKey keyboard	160
14.4	Configuring the integration of a DiBos system	160
14.5	Configuring the integration of a DVR	161
14.6	Configuring a Bosch Allegiant device	162
14.7	Configuring a startup Command Script	162
14.8	Changing the network address of a workstation	162
14.9	Enabling Forensic Search on a workstation	163
14.10	Assigning an analog monitor group to a workstation	163
14.11	Configuring an analog monitor group	163
14.12	Adding a monitor wall	164
14.13	Configuring a communication device	164
14.14	Configuring a peripheral device	164
14.15	Configuring an SNMP trap receiver	165
14.16	Configuring a Bosch IntuiKey keyboard (workstation)	165
14.17	Configuring a Bosch IntuiKey keyboard (decoder)	165
14.18	Configuring an I/O module	166
14.19	Configuring an Allegiant CCL emulation	166
14.20	Adding a Mobile Video Service	167
14.21	Adding a video analytics device	167
15	Configuring video-based fire alarm detection	168
15.1	Configuring a fire detection camera	168
15.2	Adding an encoder to a VRM pool	169
15.3	Adding a live only encoder	169
15.4	Adding a local storage encoder	170
15.5	Configuring a fire event	171
15.6	Configuring a fire alarm	171
16	Configuring MIC IP 7000 connected to a VIDEOJET 7000 connect	172
17	Configuring server-based video analytics	173
17.1	Installing the analytics viewer application	173
17.2	Adding a video analytics device	174
18	Configuring maps and structure	175
18.1	Configuring the Logical Tree	175
18.2	Adding a device to the Logical Tree	175
18.3	Removing a tree item	175
18.4	Managing resource files	176
18.5	Adding a Command Script	177
18.6	Managing pre-configured camera sequences	177
18.7	Adding a camera sequence	179

18.8	Adding a folder	179
18.9	Adding a map	179
18.10	Adding a link to another map	180
18.11	Assigning a map to a folder	180
18.12	Managing devices on a map	181
18.13	Adding a document	181
18.14	Adding a malfunction relay	182
19	Configuring schedules	183
19.1	Configuring a Recording Schedule	183
19.2	Adding a Task Schedule	184
19.3	Configuring a standard Task Schedule	184
19.4	Configuring a recurring Task Schedule	184
19.5	Removing a Task Schedule	185
19.6	Adding holidays and exception days	185
19.7	Removing holidays and exception days	186
19.8	Renaming a schedule	186
20	Configuring cameras and recording settings	188
20.1	Copying and pasting in tables	188
20.2	Exporting the Camera Table	189
20.3	Configuring stream quality settings	189
20.4	Configuring camera properties	190
20.5	Configuring recording settings (only VRM and Local Storage)	190
20.6	Configuring recording settings (NVR only)	191
20.7	Configuring PTZ port settings	192
20.8	Configuring PTZ camera settings	193
20.9	Configuring the ROI function	193
20.10	Configuring predefined positions for the ROI function	194
20.11	Configuring the ANR function	194
20.12	Configuring dual recording in the Camera Table	194
21	Configuring events and alarms	196
21.1	Copying and pasting in tables	197
21.2	Removing a table row	197
21.3	Managing resource files	197
21.4	Configuring an event	197
21.5	Duplicating an event	198
21.6	Logging user events	198
21.7	Configuring user event buttons	199
21.8	Creating a Compound Event	199
21.9	Editing a Compound Event	200
21.10	Configuring an alarm	201
21.11	Configuring settings for all alarms	201
21.12	Configuring the pre- and post-alarm duration for an alarm	202
21.13	Triggering alarm recording with text data	202
21.14	Adding text data to continuous recording	203
21.15	Protecting alarm recording	203
21.16	Configuring blinking hot spots	204
22	Configuring Command Scripts	205
22.1	Managing Command Scripts	205
22.2	Configuring a Command Script to be started automatically	206

22.3	Importing a Command Script	206
22.4	Exporting a Command Script	206
22.5	Configuring a startup Command Script	207
23	Configuring users, permissions and Enterprise Access	208
23.1	Creating a user	208
23.2	Creating a group or account	209
23.3	Creating a dual authorization group	210
23.4	Configuring LDAP settings	210
23.5	Associating an LDAP group	211
23.6	Scheduling user logon permission	211
23.7	Configuring operating permissions	212
23.8	Configuring user interface settings	212
23.9	Configuring permissions for Logical Tree	213
23.10	Configuring permissions for events and alarms	213
23.11	Configuring camera permissions	214
23.12	Configuring decoder permissions	214
23.13	Configuring various priorities	214
23.14	Copying user group permissions	215
24	Managing configuration data	216
24.1	Activating the working configuration	216
24.2	Activating a configuration	217
24.3	Exporting configuration data	217
24.4	Importing configuration data	218
24.5	Exporting configuration data to OPC	218
24.6	Checking the status of your encoders/decoders	219
24.7	Configuring SNMP monitoring	219
24.8	Creating a report	219
25	Configuration examples	220
25.1	Adding a Bosch ATM/POS bridge	220
25.2	Adding a Bosch Allegiant input alarm	221
25.3	Adding and configuring 2 Dinion IP cameras with VRM recording	221
26	Global Configuration Client windows	223
26.1	Configuration window	223
26.2	Menu commands	224
26.3	Activation Manager dialog box	225
26.4	Activate Configuration dialog box	226
26.5	Protect Devices with Global Default Password dialog box	227
26.6	License Manager dialog box	227
26.7	License Activation dialog box	228
26.8	Reports dialog boxes	228
26.8.1	Recording Schedules dialog box	228
26.8.2	Task Schedules dialog box	228
26.8.3	Cameras and Recording Parameters dialog box	228
26.8.4	Stream Quality Settings dialog box	228
26.8.5	Event Settings dialog box	229
26.8.6	Compound Event Settings dialog box	229
26.8.7	Alarm Settings dialog box	229
26.8.8	Configured Users dialog box	229
26.8.9	User Groups and Accounts dialog box	229

26.8.10	Device Permissions dialog box	229
26.8.11	Operating Permissions dialog box	229
26.9	Alarm Settings dialog box	229
26.10	Options dialog box	229
26.11	Remote Access Settings dialog box	230
26.11.1	Port Mapping Table dialog box	231
26.12	Device Monitor dialog box	231
26.13	SNMP Settings dialog box	232
26.14	License Investigator dialog box	233
27	Devices page	234
27.1	Server List / Address Book page	234
27.1.1	Add Server dialog box	235
27.2	Initial Device Scan dialog box	236
27.3	NVR & Decoder Scan dialog box	236
27.4	IP Device Configuration dialog box	236
27.5	Set IP Addresses dialog box	237
27.6	Set Display Names dialog box	238
27.7	NVRs / Failover NVRs / Redundant NVRs page	238
27.8	Vidos NVRs page	238
27.9	DiBos page	238
27.9.1	Add DiBos System dialog box	239
27.9.2	Settings page	239
27.9.3	Cameras page	239
27.9.4	Inputs page	239
27.9.5	Relays page	240
27.10	DVR (Digital Video Recorder) page	240
27.10.1	Add DVR dialog box	240
27.10.2	Settings tab	240
27.10.3	Cameras tab	241
27.10.4	Inputs tab	241
27.10.5	Relays tab	241
27.11	Matrix Switches page	241
27.11.1	Connection page	241
27.11.2	Cameras page	242
27.11.3	Outputs page	242
27.11.4	Inputs page	243
27.12	Workstation page	243
27.12.1	Settings page	243
27.12.2	Assigned Analog Monitor Groups page	245
27.13	Decoders page	245
27.13.1	Add Encoder / Add Decoder dialog box	246
27.13.2	Edit Encoder / Edit Decoder dialog box	247
27.13.3	Enter password dialog box	249
27.14	Analog Monitor Groups page	250
27.14.1	Settings page	250
27.14.2	Advanced Configuration page	251
27.15	Monitor Wall page	252
27.15.1	Add Monitor Wall dialog box	253
27.16	Communication Devices page	253

27.16.1	E-mail/SMTP Server dialog box	254
27.16.2	Add SMS Device dialog box	254
27.16.3	SMTP Server page	254
27.16.4	Send Test E-mail dialog box	255
27.16.5	GSM Settings / SMSC Settings page	256
27.17	ATM/POS page	256
27.17.1	Add Bosch ATM/POS-Bridge dialog box	257
27.17.2	Bosch ATM/POS-Bridge page	257
27.17.3	Inputs page	258
27.17.4	DTP Settings page	258
27.17.5	ATM Settings page	258
27.18	Foyer Card Readers	259
27.18.1	Add Foyer Card Reader dialog box	259
27.18.2	Settings for Foyer Card Reader page	259
27.19	Virtual Inputs page	260
27.19.1	Add Virtual Inputs dialog box	260
27.20	SNMP page	261
27.20.1	Add SNMP dialog box	261
27.20.2	SNMP Trap Receiver page	261
27.20.3	SNMP Trap Logger dialog box	262
27.21	Assign Keyboard page	262
27.22	I/O Modules page	263
27.22.1	ADAM page	263
27.22.2	Inputs page	264
27.22.3	Relays page	264
27.23	Allegiant CCL Emulation page	264
27.24	Mobile Video Service page	265
27.24.1	Add Mobile Video Service dialog box	265
27.25	Intrusion panels page	265
27.25.1	Add Intrusion Panel dialog box	266
27.25.2	Settings page	266
27.26	Video Analytics Settings page	266
27.26.1	Add Video Analytics Device dialog box	267
27.27	Bosch VMS Scan Wizard	267
27.28	VRM Devices page	269
27.28.1	Add VRM dialog box	270
27.28.2	Add Failover VRM dialog box	271
27.29	VRM Settings page	271
27.29.1	SNMP page	271
27.29.2	Accounts page	271
27.29.3	Advanced page	272
27.30	Pool page	272
27.30.1	Add Encoder / Add Decoder dialog box	273
27.30.2	Edit Encoder / Edit Decoder dialog box	274
27.30.3	Change Pool for dialog box	276
27.30.4	Add Video Streaming Gateway dialog box	277
27.31	iSCSI device page	277
27.31.1	Add iSCSI Device dialog box	278
27.31.2	Add DSA E-Series Device dialog box	278

27.31.3	Load Balancing dialog box	279
27.31.4	Basic Configuration page	279
27.31.5	iqn-Mapper dialog box	280
27.31.6	LUNs page	281
27.31.7	Add LUN dialog box	281
27.32	Video Streaming Gateway device page	282
27.32.1	Multicast tab (Video Streaming Gateway)	282
27.32.2	Advanced tab (Video Streaming Gateway)	282
27.32.3	Add Bosch Encoder dialog box	283
27.32.4	Add ONVIF Encoder dialog box	284
27.32.5	Add JPEG Camera dialog box	285
27.32.6	Add RTSP Encoder dialog box	286
27.33	Live Only page	286
27.34	Local Storage page	287
27.35	Unmanaged Sites page	287
27.35.1	Add Unmanaged Site dialog box	287
27.35.2	Unmanaged Site page	287
27.35.3	Add Unmanaged Network Device dialog box	288
27.35.4	Unmanaged Network Device page	288
28	Bosch Encoder / Decoder page	290
28.1	Enter password dialog box	290
28.2	Unit Access page	291
28.2.1	Identification / Camera identification	291
28.2.2	Camera name	292
28.2.3	Version information	292
28.3	Date/Time page	292
28.4	Installer / Initialization menu	293
28.4.1	Application variant	293
28.4.2	Base frame rate	293
28.4.3	Camera LED	293
28.4.4	Mirror image	293
28.4.5	Flip image	293
28.4.6	Menu button	293
28.4.7	Heater	293
28.4.8	Reboot device	293
28.4.9	Factory defaults	293
28.4.10	Lens Wizard	293
28.5	Privacy Masks page	293
28.6	Recording Management page	294
28.7	Recording preferences page	294
28.8	Video Input page	295
28.9	Picture settings - Scene mode	296
28.9.1	Current mode	296
28.9.2	Mode ID	296
28.9.3	Copy mode to	296
28.9.4	Restore Mode Defaults	296
28.9.5	Scene mode factory defaults	297
28.9.6	Scene mode factory defaults	297
28.9.7	Scene mode factory defaults	297

28.10	Picture settings - Color	298
28.10.1	White balance	298
28.10.2	White balance	299
28.10.3	White balance	299
28.10.4	White balance	300
28.11	Picture settings - ALC	301
28.11.1	ALC mode	301
28.11.2	ALC level	301
28.11.3	Saturation (av-pk)	301
28.11.4	Exposure/frame rate	301
28.11.5	Day/night	301
28.12	Encoder Regions page	302
28.13	Camera page	302
28.13.1	ALC	304
28.13.2	Scene mode	305
28.13.3	Scene Mode Scheduler	305
28.13.4	WDR	306
28.13.5	Sharpness level	306
28.13.6	Backlight Compensation	306
28.13.7	Contrast enhancement	306
28.13.8	Intelligent DNR	307
28.13.9	Intelligent defog	307
28.14	Lens page	307
28.14.1	Focus	307
28.14.2	Iris	307
28.14.3	Zoom	308
28.15	PTZ page	308
28.16	Prepositions and Tours page	308
28.17	Sectors page	309
28.18	Misc page	309
28.19	Logs page	309
28.20	Audio page	309
28.21	Relay page	310
28.22	Periphery page	311
28.22.1	COM1	311
28.23	VCA page	311
28.23.1	Motion detector (MOTION+ only)	312
28.23.2	Select Area dialog box	313
28.23.3	Tamper detection	314
28.24	Network Access page	315
28.24.1	JPEG posting	317
28.24.2	FTP server	317
28.25	DynDNS	317
28.25.1	Enable DynDNS	317
28.25.2	Provider	318
28.25.3	Host name	318
28.25.4	User name	318
28.25.5	Password	318
28.25.6	Force registration now	318

28.25.7	Status	318
28.26	Network Management	318
28.26.1	SNMP	318
28.26.2	UPnP	318
28.26.3	Quality of Service	319
28.27	Advanced page	319
28.27.1	SNMP	319
28.27.2	802.1x	319
28.27.3	RTSP	319
28.27.4	UPnP	319
28.27.5	TCP metadata input	320
28.28	Multicast page	320
28.29	Accounts	321
28.30	IP v4 Filter	321
28.31	Licenses page	321
28.32	Certificates page	321
28.33	Maintenance page	322
28.34	Decoder page	322
28.34.1	Decoder profile	322
28.34.2	Monitor display	323
29	ONVIF page	324
29.1	ONVIF Encoder page	324
29.2	ONVIF Encoder Events page	325
29.2.1	Add / Rename ONVIF Mapping Table dialog box	326
29.2.2	Import Mapping Table dialog box	327
29.3	ONVIF Configuration page	327
29.3.1	Unit Access	328
29.3.2	Date / Time	328
29.3.3	User Management	329
29.3.4	Video Encoder Profile page	330
29.3.5	Audio Encoder Profile	332
29.3.6	Imaging General	333
29.3.7	Backlight Compensation	333
29.3.8	Exposure	334
29.3.9	Focus	335
29.3.10	Wide Dynamic Range	336
29.3.11	White balance	336
29.3.12	Network Access	337
29.3.13	Scopes	339
29.3.14	Relays	340
29.4	ONVIF Event Source page	340
30	Maps and Structure page	342
30.1	Resource Manager dialog box	343
30.2	Select Resource dialog box	343
30.3	Sequence Builder dialog box	344
30.4	Add Sequence dialog box	345
30.5	Add Sequence Step dialog box	345
30.6	Add URL dialog box	345
30.7	Select Map for Link dialog box	346

30.8	Malfunction Relay dialog box	346
30.9	Link to External Application dialog box	346
31	Schedules page	348
31.1	Recording Schedules page	348
31.2	Task Schedules page	349
32	Cameras and Recording page	350
32.1	Cameras page	350
32.2	Scheduled Recording Settings dialog box (only VRM and Local Storage)	353
32.3	Recording settings pages (NVR only)	355
32.4	Stream Quality Settings dialog box	356
32.5	PTZ/ROI Settings dialog box	357
33	Events page	359
33.1	Debounce Settings tab	360
33.2	Settings tab for advanced map display	360
33.3	Settings tab for event configuration	361
33.4	Command Script Editor dialog box	361
33.5	Create Compound Event / Edit Compound Event dialog box	362
33.6	Select Script Language dialog box	362
33.7	Edit Priorities of Event Type dialog box	363
33.8	Select Devices dialog box	363
33.9	Text Data Recording dialog box	363
34	Alarms page	364
34.1	Alarm Settings dialog box	365
34.2	Select Image Pane Content dialog box	365
34.3	Select Resource dialog box	366
34.4	Alarm Options dialog box	366
35	User Groups page	370
35.1	New User Group/Enterprise Account dialog box	371
35.2	User Group Properties page	372
35.3	User Properties page	373
35.4	Add New Dual Authorization Group dialog box	374
35.5	Logon Pair Properties page	374
35.6	Select User Groups dialog box	375
35.7	Camera Permissions page	375
35.8	Control Priorities	376
35.9	Copy User Group Permissions dialog box	377
35.10	Decoder Permissions page	377
35.11	Events and Alarms page	378
35.12	LDAP Server Settings dialog box	378
35.13	Credentials page	380
35.14	Logical Tree page	381
35.15	Operator Features page	381
35.16	Priorities page	384
35.17	User Interface page	384
35.18	Server Access page	385
36	Troubleshooting	387
36.1	Configuring the desired language in Windows	389
36.2	Reestablishing the connection to a Bosch IntuiKey keyboard	389
36.3	Reducing the number of Allegiant cameras	389

36.4	Used ports	390
36.5	Enabling logging for ONVIF events	394
	Glossary	396
	Index	407

1 Using the Help

To find out more about how to do something in Bosch VMS, access the online Help using any of the following methods.

To use the Contents, Index, or Search:

- ▶ On the **Help** menu, click **Help**. Use the buttons and links to navigate.

To get help on a window or dialog:

- ▶ On the toolbar, click .

OR

- ▶ Press F1 for help on any program window or dialog.

1.1 Finding information

You can find information in the Help in several ways.

To find information in the Online Help:

1. On the **Help** menu, click **Help**.
2. If the left-hand pane is not visible, click the **Show** button.
3. In the Help window, do the following:

Click:	To:
Contents	Display the table of contents for the Online Help. Click each book to display pages that link to topics, and click each page to display the corresponding topic in the right-hand pane.
Index	Search for specific words or phrases or select from a list of index keywords. Double-click the keyword to display the corresponding topic in the right-hand pane.
Search	Locate words or phrases within the content of your topics. Type the word or phrase in the text field, press ENTER, and select the topic you want from the list of topics.

Texts of the user interface are marked **bold**.

- ▶ The arrow invites you to click on the underlined text or to click an item in the application.

Related Topics

- ▶ Click to display a topic with information on the application window you currently use. This topic provides information on the application window controls.

Concepts, page 23 provides background information on selected issues.

Caution!

Medium risk (without safety alert symbol): Indicates a potentially hazardous situation.

If not avoided, this may result in property damage or risk of damage to the unit.

Cautionary messages should be heeded to help you avoid data loss or damaging the system.



Notice!

This symbol indicates information or a company policy that relates directly or indirectly to the safety of personnel or protection of property.

1.2 Printing the Help

While using the Online Help, you can print topics and information right from the browser window.

To print a Help topic:

1. Right-click in the right pane and select **Print**.
The **Print** dialog box opens.
2. Click **Print**. The topic is printed to the specified printer.







2 Introduction

Click the link to access the Open Source Software licenses used by Bosch VMS and the Mobile App:

<http://www.boschsecurity.com/oss/>



1	Menu bar	Allows you to select a menu command.
2	Toolbar	Displays the available buttons. Point to an icon to display a tooltip.
3	Playback controls	Allows you to control instant playback or a camera sequence or alarm sequence.
4	Performance meter	Displays the CPU usage and the memory usage.
5	Time zone selector	Select an entry for the time zone to be displayed in most time related fields. Only available if at least one Management Server or unmanaged site in the Logical Tree is located in another time zone as your Operator Client.
6	Controls for Image panes	Allows you to select the required number of Image panes and to close all Image panes.

7	Image window	Displays the Image panes. Allows you to arrange the Image panes.
8	Image pane	Displays a camera, a map, an image, a document (HTML file).
9	 Alarm List window	Displays all alarms that the system generates. Allows you to accept or clear an alarm or to start a workflow, for example, by sending an E-mail to a maintenance person. The Alarm List is not being displayed, when the connection to the Management Server is lost.
10	 Monitors window (only available if at least one analog monitor group has been configured)	Displays the configured analog monitor groups. Allows you to switch to the next or previous analog monitor group if available. Note: The Monitors tab is not visible if your Operator Client is connected to more than one Management Server.
	 PTZ Control window	Allows you to control a PTZ camera.
11	 Logical Tree window	Displays the devices your user group has access to. Allows you to select a device for assigning it to an Image pane.
	 Favorites Tree window	Allows you to organize the devices of the Logical Tree as required.
	 Bookmarks window	Allows to manage bookmarks.
	 Map window	Displays a site map. Allows you to drag the map to display a particular section of the map. If activated, a map is displayed automatically for each camera displayed in an Image pane. In this case, the camera must be configured on a map.

This manual guides you through the basic steps of the configuration and operation with Bosch VMS.

For detailed help and step-by-step instructions read the Configuration Manual and the User Manual or use the Online Help.

Bosch VMS integrates digital video, audio and data across any IP network.

The system consists of the following software modules:

- Management Server
- VRM recording (Video Recording Manager)
- Operator Client (VRM recording / DiBos DVRs / iSCSI recording / VIDOS NVRs / local recording)
- Configuration Client

To achieve a running system, you must perform the following tasks:

- Install services (Management Server and VRM)
- Install Operator Client and Configuration Client
- Connect to network
- Connect devices to network
- Basic configuration:
 - Add devices (e.g. by device scan)
 - Build logical structure
 - Configure schedules, cameras, events, and alarms
 - Configure user groups

Bosch VMS Archive Player displays exported recordings.

3 System overview

If you plan to install and configure Bosch VMS, participate in a system training on Bosch VMS. Refer to the Release Notes of the current Bosch VMS version for supported versions of firmware and hardware and other important information.

See data sheets on Bosch workstations and servers for information on computers where Bosch VMS can be installed.

The Bosch VMS software modules can optionally be installed on one PC.

Important components

- Management Server (selectable in Setup): Stream management, alarm management, priority management, Management logbook, user management, device state management. Additional Enterprise System license: Managing Enterprise User Groups and Enterprise Accounts.
- Config Wizard: Easy and fast setup of a recording system.
- Configuration Client (selectable in Setup): System configuration and administration for Operator Client.
- Operator Client (selectable in Setup): Live monitoring, storage retrieval and playback, alarm and accessing multiple Management Server computers simultaneously.
- Video Recording Manager (selectable in Setup): Distributing storage capacities on iSCSI devices to the encoders, while handling load balancing between multiple iSCSI devices. Streaming playback video and audio data from iSCSI to Operator Clients.
- Mobile Video Service (selectable in Setup): Provides a transcoding service that transcodes the live and recorded video stream from a camera configured in Bosch VMS to the available network bandwidth. This service enables video clients like an iPhone or a Web client to receive transcoded streams, for example for unreliable network connections with limited bandwidth.
- Web Client: You can access live and playback videos via Web browser.
- Mobile App: You can use the Mobile App on iPhone or iPad to access live and playback video.
- Bosch Video Streaming Gateway (selectable in Setup): Provides the integration of 3rd party cameras and NVR-like recording, e.g. in low-bandwidth networks.
- Cameo SDK (selectable in Setup): The Cameo SDK is used to embed Bosch VMS live and playback Image panes to your external third-party application. The Image panes follow the Bosch VMS based user permissions.
The Cameo SDK provides a subset of the Bosch VMS Operator Client functionalities that enables you to create applications similar to the Operator Client.
- Client Enterprise SDK: The Client Enterprise SDK is meant to control and monitor the behaviour of Operator Client of an Enterprise System by external applications. The SDK allows to browse devices that are accessible by the running, connected Operator Client and to control some UI functionalities.
- Client SDK / Server SDK: The Server SDK is used to control and monitor the Management Server by scripts and external applications. You can use those interfaces with a valid administrator account.
The Client SDK is used to control and monitor the Operator Client by external applications and scripts (part of the related server configuration).

3.1 Hardware requirements

See the data sheet for Bosch VMS. Data sheets for platform PCs are also available.

3.2 Software requirements

See the data sheet for Bosch VMS.

Bosch VMS must not be installed on a computer where you want to install Bosch VMS Archive Player.

3.3 License requirements

See the data sheet for Bosch VMS for the available licenses.

4 Concepts

This chapter provides background information on selected issues.

4.1 Recording settings

Recording settings in Bosch VMS consist of basic settings (non-scheduled) and scheduled recording settings.

Use the basic settings for the initial configuration of streams.

Use the scheduled recording settings for assigning these streams to different use-cases, such as continuous recording, pre-alarm recording, or alarm recording. The recording settings are arranged in the **Scheduled Recording Settings** dialog box accessible on the **Cameras and Recording** page.

4.1.1 Basic stream settings (schedule-independent)

You can configure different codec profiles in the **Cameras and Recording** page of Configuration Client.

Stream 1		Stream 2		Live Video		Recording					Secondary Recording		
Codec	Quality	Codec	Quality	Stream	ROI	Setting	ANR	Max	Storage	Storage	Setting	Storage	Storage
H.264 MP 1080p25/30 fixed	Bit Rate Optimize	H.264 MP 1080p4/5 fixed	Bit Rate Optimized	Stream 2	<input type="checkbox"/>	Continuous, Alarm Recording	<input type="checkbox"/>		1	30	Continuous, Alarm Recording	1	
H.264 MP HD 2640x2640	Bit Rate Optimize	H.264 MP HD 800x800	Balanced	Stream 2	<input type="checkbox"/>	Continuous, Alarm Recording	<input type="checkbox"/>		1	30	Continuous, Alarm Recording	1	
H.264 MP 1080p25/30 fixed	Bit Rate Optimize	Copy from Stream 1	Quality of Stream 1	Stream 2	<input type="checkbox"/>	Continuous, Alarm Recording	<input type="checkbox"/>		1	30	Continuous, Alarm Recording	1	
H.264 MP 720p50/60 fixed	Bit Rate Optimize	Copy from Stream 1	Quality of Stream 1	Stream 2	<input type="checkbox"/>	Continuous, Alarm Recording	<input type="checkbox"/>		1	30	Continuous, Alarm Recording	1	

Codecs and HD resolution

Codecs are part of the basic stream settings. Bosch VMS gives you default settings for all codecs and qualities. You can change these settings.

It depends on the camera device type which codec you can select.

4.1.2 Stream assignment for Live

You can assign either stream 1 or stream 2 for Live. The quality and codec of the basic stream settings are used.

Stream 1		Stream 2		Live Video		Recording					Secondary Recording		
Codec	Quality	Codec	Quality	Stream	ROI	Setting	ANR	Max	Storage	Storage	Setting	Storage	Storage
H.264 MP 1080p25/30 fixed	Bit Rate Optimize	H.264 MP 1080p4/5 fixed	Bit Rate Optimized	Stream 2	<input type="checkbox"/>	Continuous, Alarm Recording	<input type="checkbox"/>		1	30	Continuous, Alarm Recording	1	
H.264 MP HD 2640x2640	Bit Rate Optimize	H.264 MP HD 800x800	Balanced	Stream 2	<input type="checkbox"/>	Continuous, Alarm Recording	<input type="checkbox"/>		1	30	Continuous, Alarm Recording	1	
H.264 MP 1080p25/30 fixed	Bit Rate Optimize	Copy from Stream 1	Quality of Stream 1	Stream 2	<input type="checkbox"/>	Continuous, Alarm Recording	<input type="checkbox"/>		1	30	Continuous, Alarm Recording	1	
H.264 MP 720p50/60 fixed	Bit Rate Optimize	Copy from Stream 1	Quality of Stream 1	Stream 2	<input type="checkbox"/>	Continuous, Alarm Recording	<input type="checkbox"/>		1	30	Continuous, Alarm Recording	1	

4.1.3 Scheduled Recording Settings

To display the **Scheduled Recording Settings** dialog box, click **Edit scheduled recording settings** in the toolbar of the **Cameras and Recording** page.

Cameras are typically grouped by location and/or schedule (e.g. **Alarm Recording Night and Weekend**), and not by technical differences between camera models.

You can map these groups as templates in the **Scheduled Recording Settings** dialog box. You perform all recording configurations in this dialog box.

Continuous, Alarm Recording is the default setting for a camera that is added to Bosch VMS.

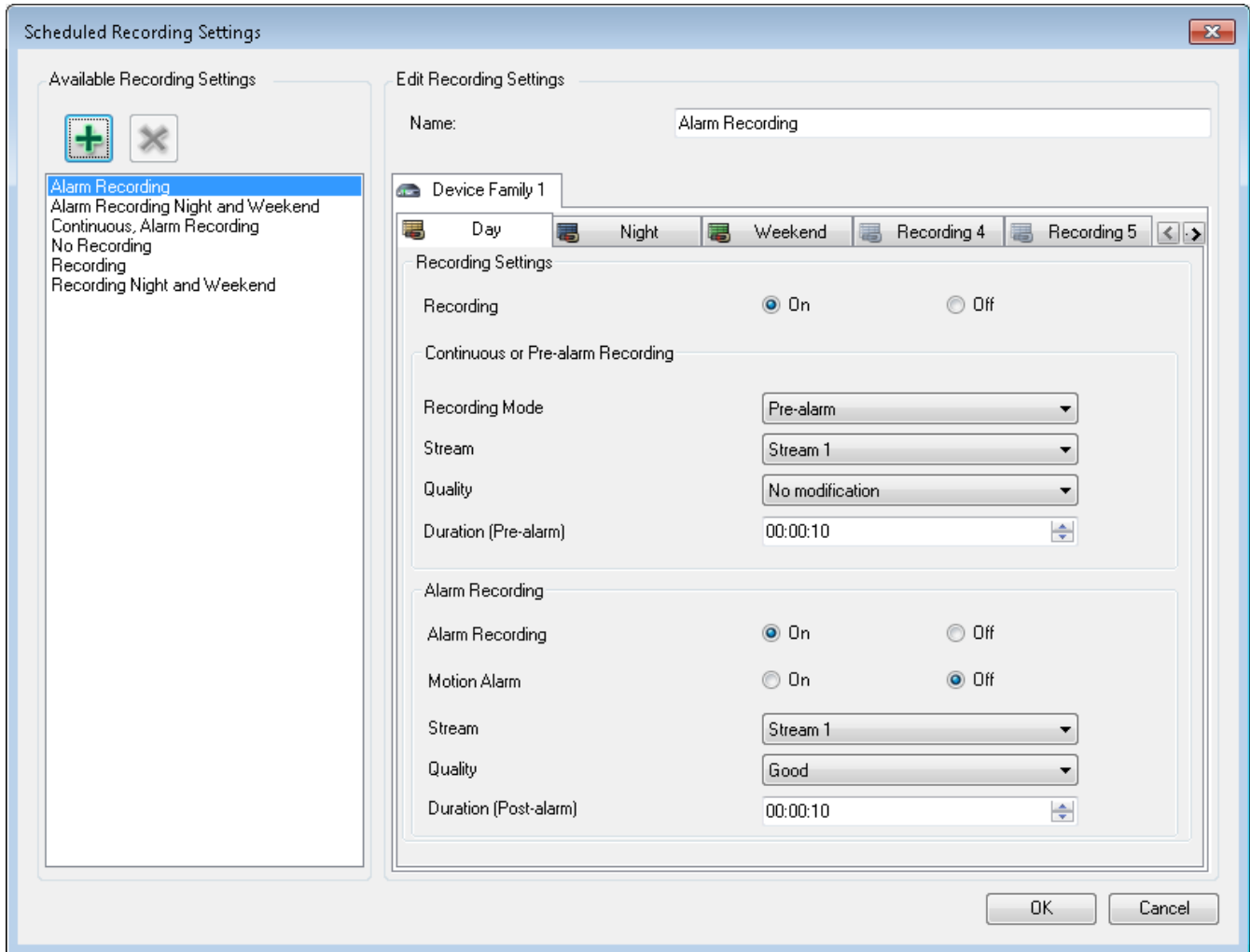

Stream 1		Stream 2		Live Video	Recording	Secondary Recording							
Codec	Quality	Codec	Quality	Strea	ROI	Setting	ANR	Max	Storage	Storage	Setting	Storage	Storage Me
H.264 MP 1080p25/30 fixed	Bit Rate Optimize	H.264 MP 1080p4/5 fixed	Bit Rate Optimized	Stream 2		Continuous, Alarm Recording			1	30	Continuous, Alarm Recording		1
H.264 MP HD 2640x2640	Bit Rate Optimize	H.264 MP HD 800x800	Balanced	Stream 2		Continuous, Alarm Recording			1	30	Continuous, Alarm Recording		1
H.264 MP 1080p25/30 fixed	Bit Rate Optimize	Copy from Stream 1	Quality of Stream 1	Stream 2		Continuous, Alarm Recording			1	30	Continuous, Alarm Recording		1
H.264 MP 720p50/60 fixed	Bit Rate Optimize	Copy from Stream 1	Quality of Stream 1	Stream 2		Continuous, Alarm Recording			1	30	Continuous, Alarm Recording		1

In the dialog you configure for a device family and a schedule which stream for the selected recording mode is to be used. Usually you should not configure the quality for devices of **Device Family 2** or **Device Family 3** in this dialog box. Select the quality for each camera individually in the Recording Table. The quality settings of the dialog are only active for Secondary Recording, when on the stream no Primary Recording is active. For **Device Family 1** we recommend configuring a quality setting in the dialog, not in the Recording Table. In the **Scheduled Recording Settings** dialog box, you configure the recording settings of the devices. Bosch VMS displays pre-defined recording settings (templates). You can modify these templates to your needs or you can add templates. You can configure the recording settings per device family independently per schedule. Possible recording settings are:

	Device Family 1	Device Family 2	Device Family 3
Recording Settings			
Recording	On / Off (setting valid for all device families)		
Continuous or Pre-alarm Recording			

	Device Family 1	Device Family 2	Device Family 3
Recording Mode	Continuous Pre-alarm	Continuous Pre-alarm	Continuous Pre-alarm
Stream	Stream1	Stream1 Stream2	Stream1 Stream2 I-frame only (from Stream1)
Quality	No modification Pre-defined / user-defined qualities (recommended)	No modification (recommended) Pre-defined / user-defined qualities	No modification (recommended) Pre-defined / user-defined qualities
Duration (Pre-alarm)	10s - 3h For pre-alarm recording of less than 10 seconds the RAM of the camera is used.	10s - 3h For pre-alarm recording of less than 10 seconds the RAM of the camera is used.	10s - 3h For pre-alarm recording of less than 10 seconds the RAM of the camera is used.
Alarm Recording			
Alarm Recording	On / Off (setting valid for all device families)	On / Off (setting valid for all device families)	On / Off (setting valid for all device families)
Motion Alarm	On / Off (setting valid for all device families)	On / Off (setting valid for all device families)	On / Off (setting valid for all device families)
Stream	Stream 1	Stream 1 Stream 2	Stream 1 Stream 2 I-frame only (from Stream1)
Quality	Good (recommended) Pre-defined / user-defined qualities	No modification (recommended) Pre-defined / user-defined qualities	No modification (recommended) Pre-defined / user-defined qualities
Duration (Post-alarm)	1s - 3h	1s - 3h	1s - 3h

Enter a descriptive name for your configuration which is then displayed in the **Available Recording Settings** list.

You can select all configured recording settings in the **Recording - Setting** column. Assign one recording setting per camera. You can copy and paste one setting to all cameras for fast configuration.

Changing qualities in schedules

You can configure stream qualities per recording schedule. Depending on the used device family, you can modify the quality properties.

Device Family 1	Device Family 2 or Device Family 3
Streams	Alarm Recording
You can change recording qualities (incl. resolution change) for alarm recording.	You can modify the existing stream with the settings of another stream quality. But only the Image encoding interval value and the Target bit rate [Kbps] value are modified. Other settings like the resolution are not modified.

Device Family 1	Device Family 2 or Device Family 3
Notes	
For the XFM4 platform possible recording gaps can be up to 4 frames, 133/160ms (NTSC/PAL) on alarm recording and schedule change if active recording quality differs.	Possible recording gaps can be up to 12 frames, with 1 IPS up to 12 seconds on schedule change if active recording quality differs from old to new schedule.
Examples	
	Stream 2 is selected for normal recording and configured with Normal quality. For an alarm, the Excellent quality is selected. When an alarm occurs, all settings of the Normal quality are used except the Image encoding interval value and the Target bit rate [Kbps] value which are modified with the values of Excellent .

4.2 Config Wizard

Intended use for Config Wizard is the quick and easy configuration of a smaller system. Config Wizard helps you to achieve a configured system including VRM, iSCSI system, Mobile Video Service, cameras, recording profiles and user groups.

You must add iSCSI systems manually on a standard software installation.

User groups and their permissions are configured automatically. You can add or remove users and set passwords.

Config Wizard can access Management Server only on the local computer.

You can save an activated configuration for backup purposes and import this configuration later. You can change this imported configuration after import.

Config Wizard adds the local VRM automatically both on a standard software installation and on DIVAR IP 3000 and DIVAR IP 7000.

On a DIVAR IP 3000 and on a DIVAR IP 7000 the local iSCSI device is also added automatically if not already available.

On a DIVAR IP 3000 and on a DIVAR IP 7000, a local Mobile Video Service is added automatically if not already available.



Notice!

If you want to use decoders in your system, make sure that all encoders use the same password for the user authorization level.

See also

- *Using Config Wizard, page 87*

4.3 Enterprise System

The target of a Bosch VMS Enterprise System is to enable a user of Operator Client to simultaneously access multiple Management Servers.

See also

- *Creating an Enterprise System, page 108*
- *Configuring the Server List for Enterprise System, page 109*

- *Configuring users, permissions and Enterprise Access, page 208*
- *Accessing the system, page 97*

4.3.1

Scenarios

The following three scenarios are covered.

- **Scenario 1:** A dedicated server plays the role of Enterprise Management Server. This server has the only task to manage the simultaneous access of an Operator Client workstation to multiple Management Servers.

An Operator Client workstation logs on to Enterprise Management Server. After successful logon the user of Operator Client has access to the devices of all configured Management Servers according to the permissions in his Enterprise User Group.

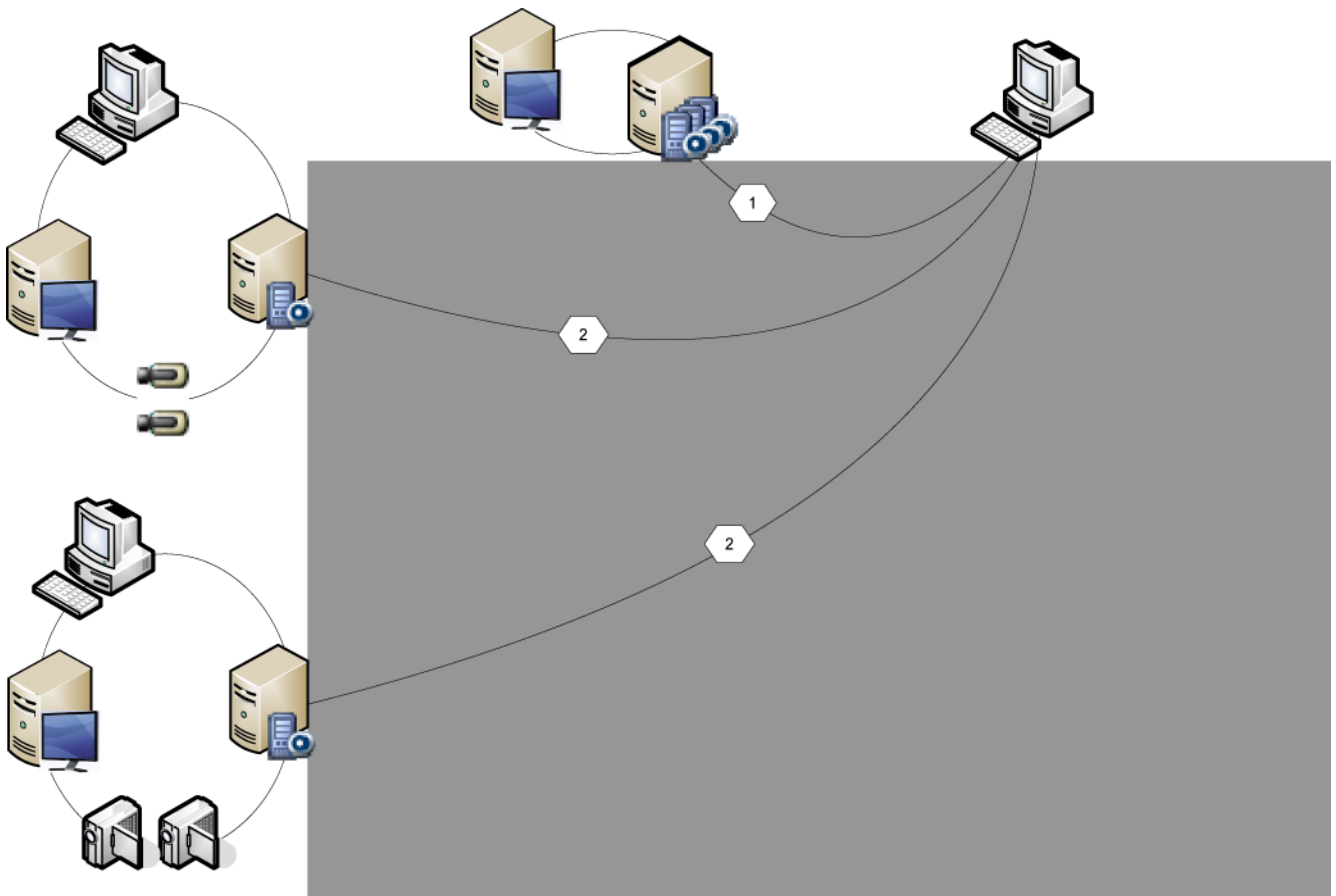







Figure 4.1: Enterprise Scenario 1

	Management Server
	Operator Client

	Configuration Client
	IP camera / encoder
	Enterprise Management Server

- **Scenario 2:** Combination of Enterprise Management Server and Management Server role. In this case the own Management Server must also be part of the Enterprise Management Server configuration.

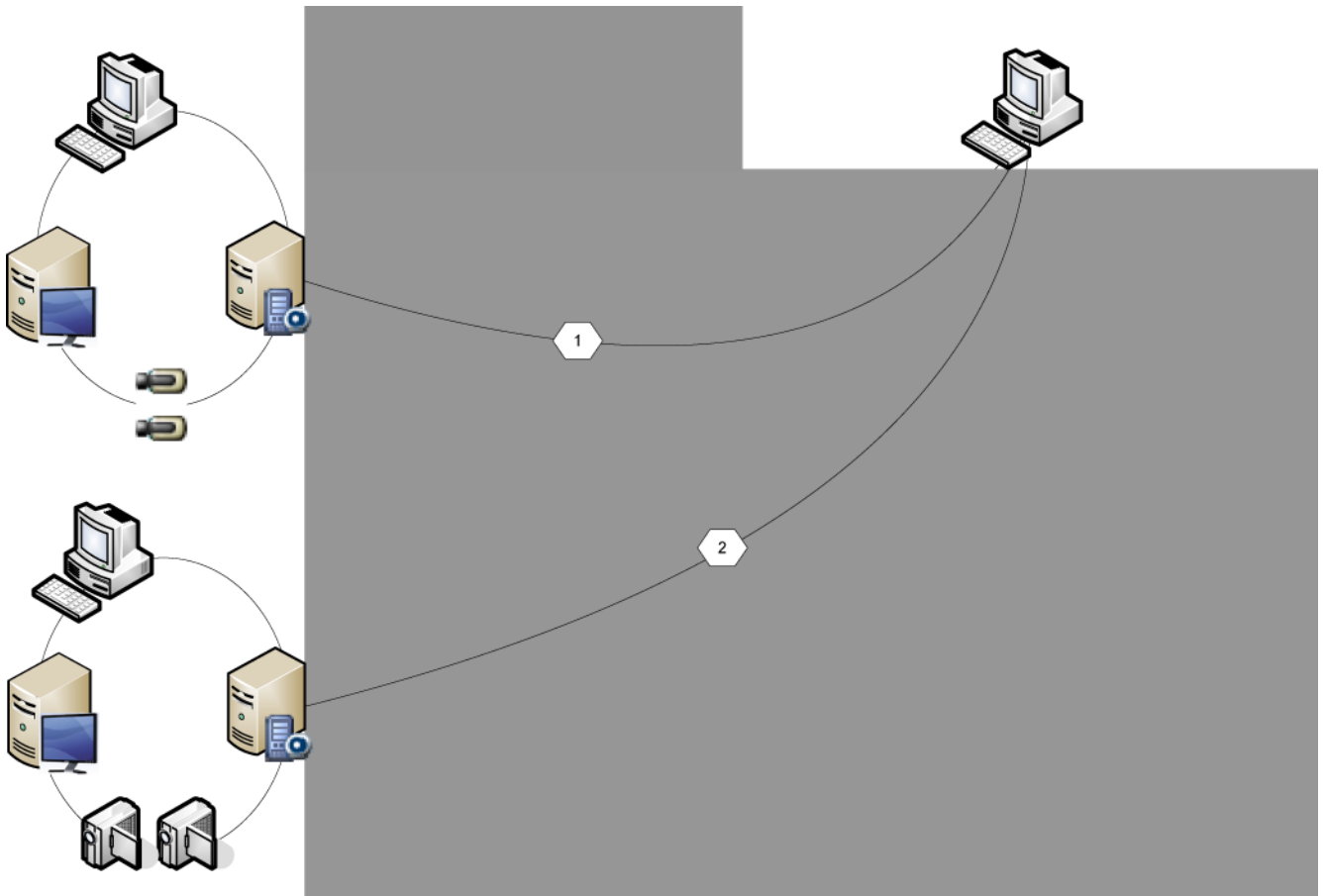
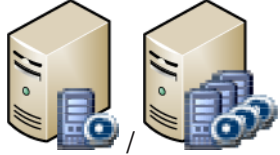





Figure 4.2: Enterprise Scenario 2

	Management Server / Enterprise Management Server
	Operator Client
	Configuration Client
	IP camera / encoder

- **Scenario 3:** The classic client-server architecture remains supported.

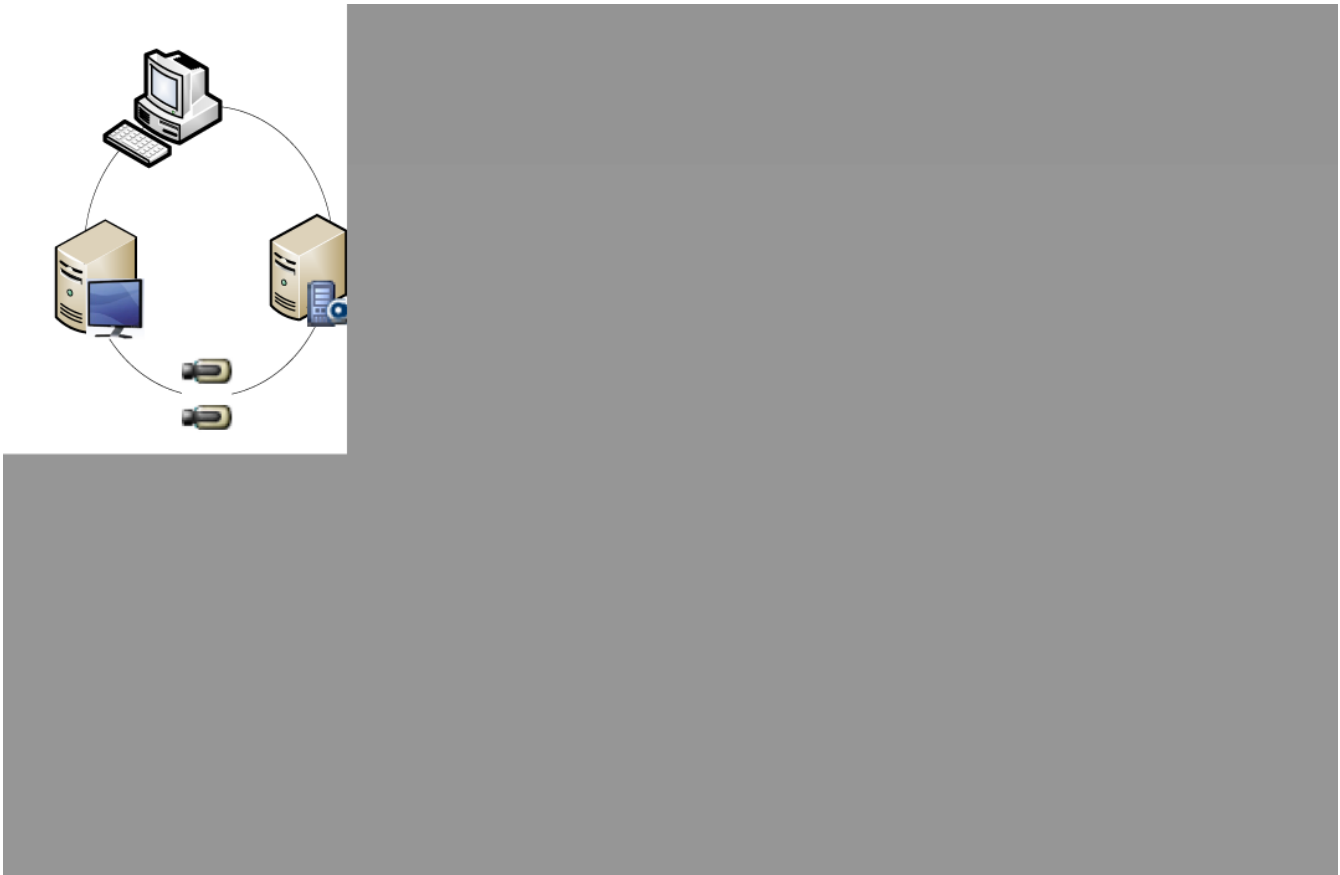





Figure 4.3: Classic Scenario 3

	Management Server
	Operator Client
	Configuration Client
	IP camera / encoder

4.3.2

Permissions

Permissions on an Enterprise System

For an Enterprise System you configure the following permissions:

- Operating permissions of Operator Client defining the user interface for operating in the Enterprise System, for example the user interface of the alarm monitor. Use an Enterprise User Group. Configure it on the Enterprise Management Server.

- Device permissions that should be available for operating in an Enterprise Management Server are defined on each Management Server.
Use Enterprise Accounts. Configure it on each Management Server.

Permissions on a single Management Server

For managing the access to one of the Management Servers, use the standard user group. You configure all permissions on this Management Server in this user group. You can configure dual authorization user groups for standard user groups and for Enterprise User Groups.

4.3.3 Types of user groups

Type	Contains	Available configuration settings	Where do you configure?
User group	Users	- Operating and device permissions	- Management Server
Enterprise User Group	Users	- Operating permissions - Per Management Server: Name of the corresponding Enterprise Access Accounts with logon credentials	- Enterprise Management Server
Enterprise Account	-	- Device permissions - Account password	- Management Server
Dual authorization user group	User groups	- See user groups	- See user groups
Enterprise dual authorization	Enterprise User Groups	- See Enterprise User Groups	- See Enterprise User Groups

4.3.4 Licensing

Bosch VMS Enterprise (MBV-BENT) version license is required at each Enterprise Management Server to enable the feature.

For each Management Server assigned to one or more Enterprise User Groups, 1 license (MBV-XSUB) is required.

To update an existing MBV-BPRO Base license to an Enterprise System, you need an Enterprise Upgrade license (MBV-FEUP).

Each Workstation connecting to an Enterprise Management Server requests one MBV-XWST that is licensed at Enterprise Management Server. No additional MBV-XWST license is required on each Management Server if accessed via Enterprise Management Server.

4.4 Unmanaged site

Operator Client

The user of Operator Client of system A can connect to another system B. System B is called unmanaged site, indicated by . The user can for example perform the following tasks on the video network devices of system B:

- Display live and playback.
- Export video.

- Delete video.
- Protect and unprotect video.
- Create and print a snapshot.

The user of Operator Client can switch the time zone if an unmanaged site is configured to be located in another time zone.

Configuration Client

In the Device Tree of Configuration Client of Bosch VMS A, you can add the network devices of system B to an unmanaged site item.

You can add the following device types as system B:

- DVR
- DIVAR IP 3000/7000
- Bosch VMS

You can add an unmanaged site to the Logical Tree multiple times, for example to folders configured as maps.

If port mapping is enabled in the remote access settings of system B then the public network address can also be used in the settings of the unmanaged network device configured in system A.

You can configure the time zone of an unmanaged site. This is useful when a user of Operator Client wants to access an unmanaged site using a computer with Operator Client located in another time zone than this unmanaged site.

Credentials for an unmanaged site

When adding a network device to an unmanaged site, you must type in the IP address and select the correct device type of this network device. It is optional to enter credentials for this network device. IP address and the credentials are not checked from within Configuration Client.

When the user of Operator Client connects to an unmanaged site, the credentials that were entered in Configuration Client, are used for logon to the network devices of this unmanaged site if available. If no credentials are available in the configuration, the credentials of the current Operator Client logon are automatically used.

Security considerations

When a user of Operator Client in system A accesses system B via unmanaged site access, keep the following security related considerations in mind:

- All user actions on cameras of system B performed in system A, are not logged on both the systems.
- Operator Client of system A does not enforce the operating permissions configured in system B.
- Operator Client of system A enforces the device permissions configured in system B.
- If an administrator of system A knows a valid user account of system B, system B cannot prevent system A from connecting to system B as an unmanaged network device.

Limitations

For supported video network devices and limitations, see the Bosch VMS datasheet.

See also

- *Adding an unmanaged site, page 123*

4.4.1

Structure of CSV file for importing unmanaged sites

You can prepare a CSV file for importing unmanaged sites in Bosch VMS.

The list separator that is configured in the Regional Settings of your Operating System, is used as separator for the CSV file.

The computer where you edit the CSV file must have the same regional settings as the computer running Configuration Client.

To change the list separator (Windows 7 as an example):



- ▶ Click **Start > Control Panel > Region and Language > Additional Settings > In the List separator:** list, select the desired character.

The definition headline in the CSV file at line 4 is mandatory.

All information above the definition headline is ignored during import.

The definition headline defines the mapping of the columns to the unmanaged sites in Bosch VMS.

Possible values are listed in the following table.

Column title	Description
Site	Creates an unmanaged site. This is only allowed to appear once per line.
ConnectionString	Creates a device by connecting to the specified URI.
User	The user name for authentication. This field can be empty.
Password	The password for authentication. This field can be empty.
TimeZone	<p>The time zone of the Configuration Client computer. This field can be empty. If you leave this field empty or omit it, the time zone of the Configuration Client computer is used. Please write down the exact string that you find here:</p> <div style="text-align: center;">  </div> <p>Main window >  Devices > Right-click  > Add Unmanaged Network Device command > Add Unmanaged Network Device dialog box > list</p>

Below the definition headline, each line represents one device.

```
This is a production file to import Bosch DVRs/Bosch VMS into the Bosch Video Client;;;
Version 1.0;;;
Date: 12.07.2016;;;
Site;ConnectionString;User;Password;TimeZone
bvms_Munich_1;bvms://172.31.11.160;admin;hv5cul1r;"(UTC+01:00) Amsterdam; Berlin; Bern; Rome; Stockholm; Vienna"
bvms_Berlin_2;bvms://172.31.22.161;admin;hv5cul2r;"(UTC+01:00) Amsterdam; Berlin; Bern; Rome; Stockholm; Vienna"
dvr_Dresden_3;http://172.31.33.162;Administrator;hv5cul3r;"(UTC+01:00) Amsterdam; Berlin; Bern; Rome; Stockholm; Vienna"
dvr_NewYork_4;http://172.31.44.163;Administrator;hv5cul4r;"(UTC-05:00) Eastern Time (US & Canada)"
dvr_LosAngeles_5;http://172.31.55.165;Administrator;hv5cul5r;"(UTC-08:00) Pacific Time (US & Canada)"
```

See also

- *Importing unmanaged sites, page 123*

4.5 Server Lookup

A single user of Configuration Client or Operator Client may want to connect to multiple system access points sequentially. This access is called Server Lookup. System access points can be Management Server or Enterprise Management Server.

Server Lookup supports you in locating system access points by their names or descriptions. The user retrieves the list of system access points during logon. He needs to connect to the server hosting the configuration with **Server List / Address Book**.

When a user of Operator Client logs on using Server Lookup in offline state, the Server List of the last successful logon is displayed. Offline state here means that the Operator Client workstation does not have a network connection to the server containing the Server List.

As of Bosch VMS 5.5:

A user of Operator Client can log on to a Management Server with another version. The operator can display the Server List / Address Book of this server.

If the server has a newer version than the client, the client is updated automatically by No-touch deployment if the last successful connection of the client has been established to this server before its upgrade.





You can add further columns in the Server List according to your requirements. The user then has more search criteria to find a specific server in the Server Lookup dialog box. The added

columns are also visible on the **Server Access** page (Main window >  **User Groups** >

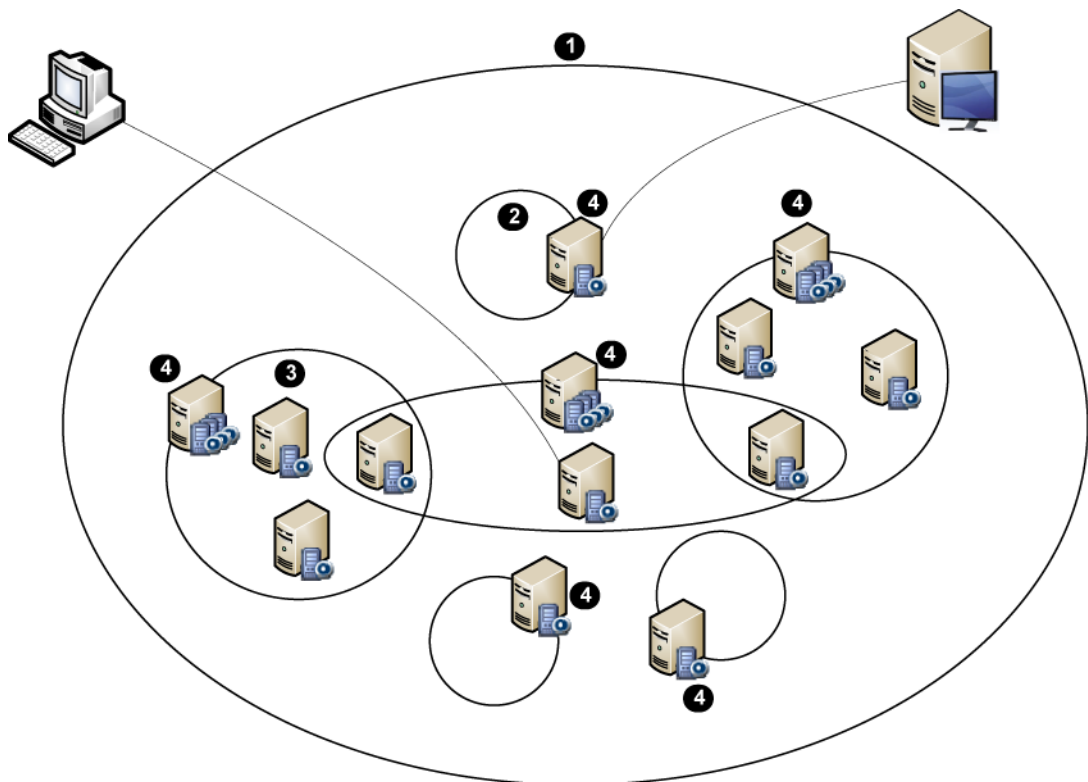
Enterprise User Group tab >  > **Server Access** tab).

The following image shows an example for Server Lookup in a multi system environment:



1	Multi system environment		Enterprise Management Server
2	Single server system		Management Server
3	Multi server system		Operator Client
4	System access point: Server on which logon request of Operator Client or Configuration Client is processed.		Configuration Client

When a client logs on to Enterprise Management Server, it is possible to get access to all Management Servers of this Enterprise System simultaneously.

See also

- *Configuring Server Lookup*, page 121
- *Server List / Address Book page*, page 234
- *Using Server Lookup*, page 98
- *Exporting the Server List*, page 122
- *Importing a Server List*, page 122

4.5.1

Server List

You can export or import a CSV file with a Server List and all configured properties. If you import a CSV file with a Server List, all previously configured servers in the **Server List / Address Book** page are overwritten with the servers in the CSV file. But if you import a server with the name of an already configured server, the settings of the **Server Access** page are



retained (Main window > **User Groups > Enterprise User Group** tab >  > **Server Access** tab).

When you edit the exported CSV file in Microsoft Excel, save the file as CSV file type (Windows ANSI), not as Unicode file type. When using an external editor for editing the exported CSV file, make sure that this editor can save your CSV file with Windows ANSI character encoding or with UTF-8 (with BOM) character encoding. Windows ANSI encoding is used for all Western European languages, UTF-8 is used for all other languages.

The list separator that is configured in the Regional Settings of your Operating System, is used as separator for the CSV file.

The computer where you edit the CSV file must have the same regional settings as the computer running Configuration Client.

To change the list separator (Windows 7 as an example):

- ▶ Click **Start > Control Panel > Region and Language > Additional Settings** > In the **List separator:** list, select the desired character.

4.6

Remote access

Caution!

To prevent unauthorized access to video data through the Internet, we strongly recommend that you protect all users and devices in the system with an appropriate password. Protect all levels of a camera / encoder (service / user / live) with a password.

Related Topics for changing passwords

- *User Properties page*, page 373
- *Changing the password of an encoder / decoder*, page 140
- *Changing the password of a VRM device*, page 133

The target of remote access in Bosch VMS is to connect different private networks to public networks.

Multiple networks with private (local) network addresses can be accessed simultaneously or sequentially by Operator Client computers via public interfaces (routers). Task of the router is to translate the incoming public network traffic to the corresponding private network address. The users of Operator Client can access Management Server or Enterprise Management Server and their devices via remote access.

You cannot access the following devices/features via remote access:

- Playback of local storage
- ONVIF
- DiBos
- Direct iSCSI replay

The following image shows an example of remote access to Bosch VMS devices in a single system:

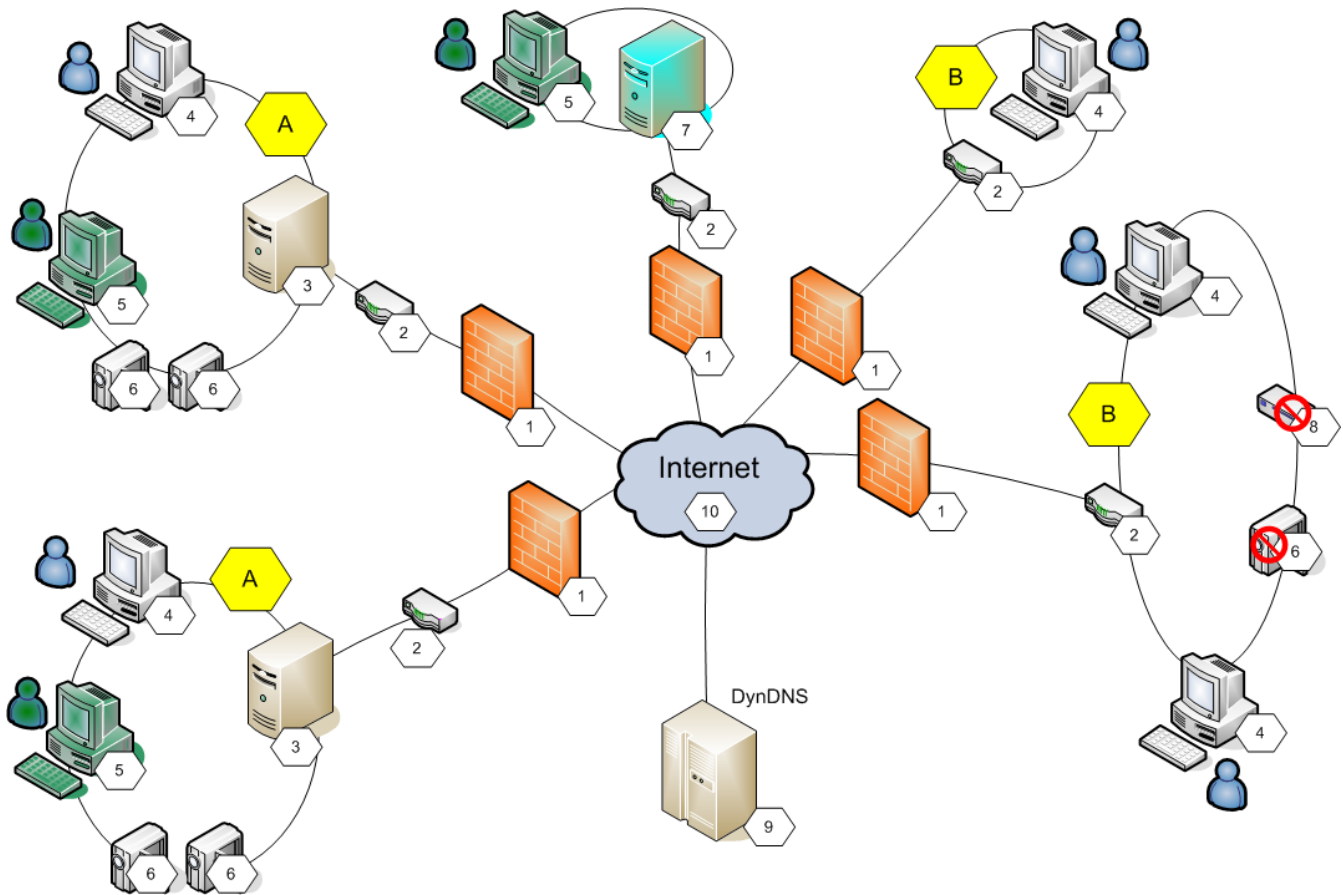

1	Firewall	6	IP camera / encoder
2	Router	7	Enterprise Management Server
3	Management Server	8	Decoder
4	Operator Client	9	DynDNS Server
5	Configuration Client	10	World Wide Web
A	Remote network	B	Local network

The following image shows an example of remote access from private network with Enterprise System to remote Bosch VMS systems:

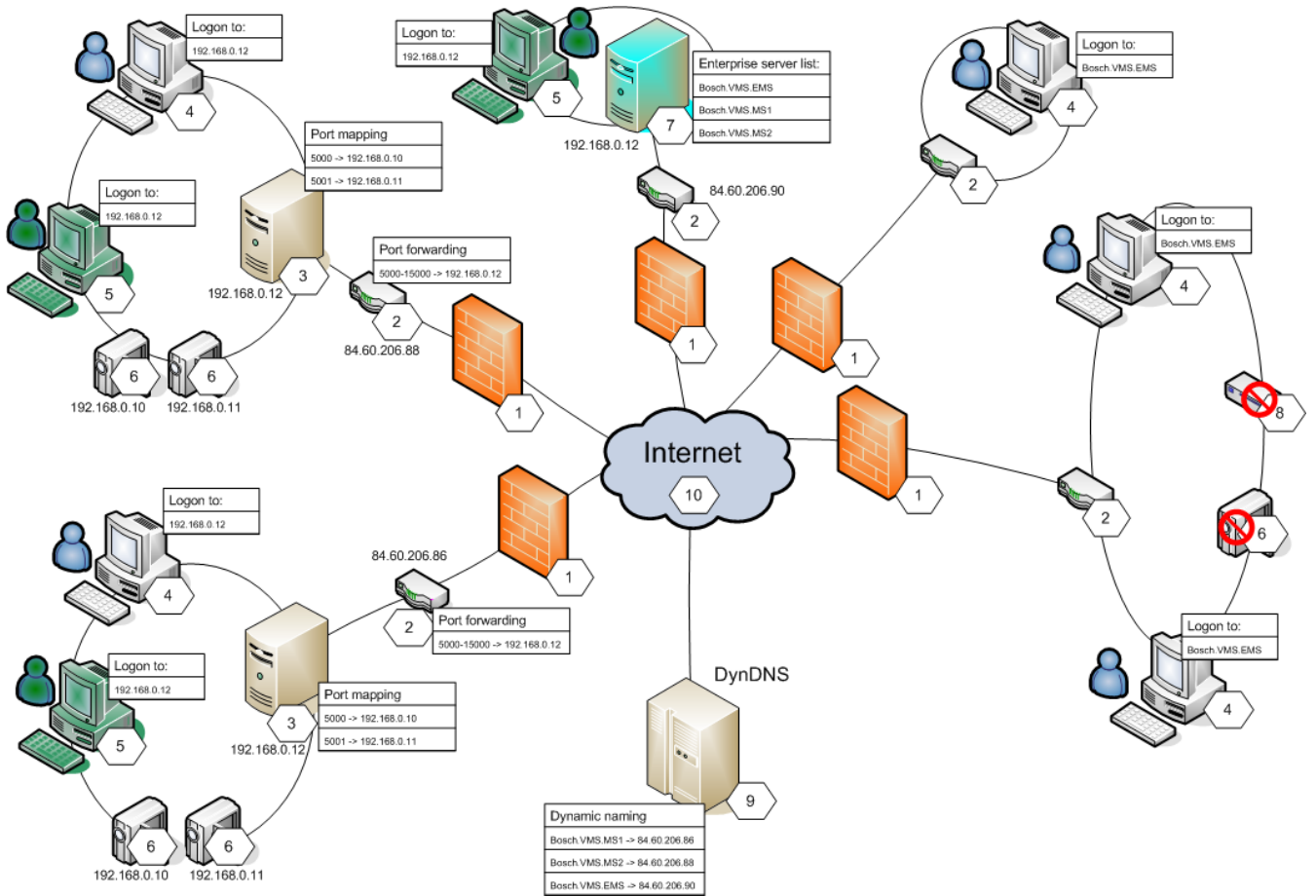

1	Firewall	6	IP camera / encoder
2	Router Port forwarding	7	Enterprise Management Server Enterprise server list
3	Management Server Port mapping	8	Decoder
4	Operator Client Logon to	9	DynDNS Server Dynamic naming
5	Configuration Client Logon to	10	World Wide Web

To enable the remote access of an Operator Client to devices in a remote network, each device is assigned a public port number in addition to the public network address of the router. For access, Operator Client uses this public port number together with the public network address. In the private network the incoming traffic for the public port number is forwarded to the private network address and port number of the corresponding device. You configure the port mapping in Configuration Client for use by Operator Client.



Notice!

Additionally the network administrator must configure the port forwarding on the router of the private network. The network administrator must ensure that remote access via these ports is running outside of Bosch VMS environment.

See also

- *Configuring remote access, page 98*
- *Remote Access Settings dialog box, page 230*
- *Port Mapping Table dialog box, page 231*

4.7 iSCSI storage pool

As of VRM v.3.0, iSCSI storage pools are introduced. A storage pool is a container for one or more iSCSI storage systems that share the same load balancing properties. The encoders / IP cameras that are assigned to a storage pool, are recorded with these common load balancing settings.

A storage pool can be used to have a logical mapping of the network topology to the VRM, for example if you have two buildings, both containing storage and devices, you want to avoid routing the network traffic from one building to the other.

Storage pools can also be used to group cameras and storage systems by an important aspect of view. For example a system contains of some very important cameras and a lot of less important ones. In this case it is possible to group them into two storage pools, one with a lot of redundancy features and one with less redundancy.

You can configure the following load balancing properties for a storage pool:

- Recording preferences (**Automatic** or **Failover**)
- Secondary target usage
Secondary target is used in case of **Failover** mode if the assigned primary target fails. If this option is turned off, the recording stops on all devices assigned to this failed primary target.
In case of **Automatic** mode: if one target fails, VRM Server performs an automatic reassign of the related devices to other storages. If VRM Server is down while a target fails, the recording is stopped on the devices currently recording on the failed target.
- Block reservation for downtime
- Sanity check period

For each pool you can configure that this pool allows LUNs larger than 2 TB.

LUNs larger than 2 TB ("large LUNs") are not supported by the following devices:

- VRM devices earlier than 3.60
- VSG devices with firmware version earlier than 6.30
- Encoders with firmware version earlier than 6.30

Bosch VMS prevents you to perform the following procedures:

- Add or move devices with firmware version earlier than 6.30 to a pool that allows large LUNs.
- Add or move devices that are currently not connected to the network, to a pool that allows large LUNs.
- Add or move an iSCSI device that contains large LUNs, to a pool that does not allow large LUNs.
- Allow large LUNs on a pool that contains devices with firmware version earlier than 6.30.
- Disable large LUNs on a pool with an iSCSI device that contains large LUNs.

Please move devices with firmware earlier than 6.30 to a pool that does not allow large LUNs.

If a Primary VRM has a pool that allows large LUNs, the corresponding Mirrored VRM inherits this setting and you cannot select or clear the **Allow LUNs larger than 2 TB** checkbox on the corresponding pool of the Mirrored VRM. If you have added an iSCSI device with large LUNs to a Mirrored VRM, you cannot clear the **Allow LUNs larger than 2 TB** checkbox on the corresponding pool of the Primary VRM.

See also

- Pool page, page 272

4.8 Automated Network Replenishment (ANR)

Intended use

When a failure of the network or the central storage occurs, the ANR function ensures that the encoder transmits the locally buffered recording of the missing time period to the central storage after the failure is fixed.

The following graphic shows the transmission of video data after a network or storage failure is fixed.

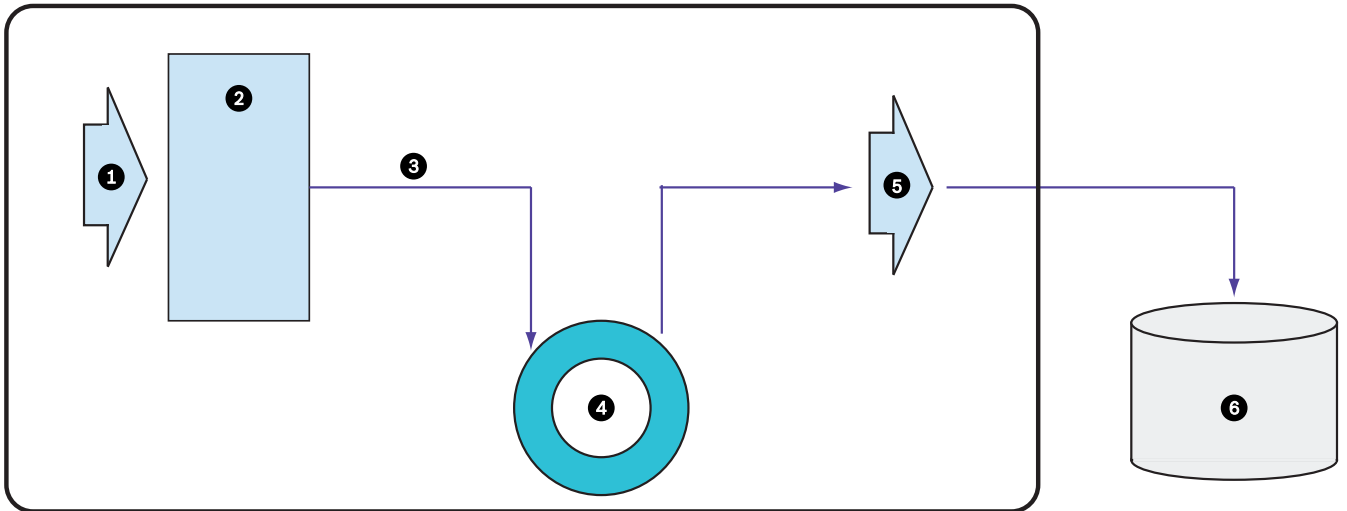

1	Video	5	IP network
2	Encoder	6	iSCSI target (central storage)
3	Write to buffer immediately		
4	SD card (ring buffer)		

Example: Work around network failure

If the network fails unexpectedly, the ANR function completes the central storage with the locally buffered recording when the network is available again.

Example: Store video data when network is not available

A subway has no network connection to the central storage when located between stations. Only during regular stops the buffered recording can be transmitted to the central storage. Ensure that the time period that is required for transferring the buffered recording, does not exceed the time period of a stop.

Example: ANR for alarm recording

The pre-alarm recording is stored locally. Only in case of an alarm, this pre-alarm recording is transmitted to the central storage. If no alarm occurs, the obsolete pre-alarm recording is not transmitted to the central storage and, hence, does not burden the network.

Limitations



Notice!

You cannot use playback from the local storage media when the passwords for `user` and `live` are set on the encoder. Remove the passwords if required.

The ANR function only works with VRM recording.

The ANR function does not work with an encoder for which a secure connection for live display is configured.

You must have configured the storage media of an encoder to use the ANR function.

The encoder for which you configure the ANR function, must have firmware version 5.90 or later. Not all encoder types support the ANR function.

You cannot use the ANR function with dual recording.

Your iSCSI storage system must be properly configured.

The following list contains the possible reasons if you cannot configure the ANR function:

- Encoder is not reachable (wrong IP address, network failure, etc.).
- Storage media of the encoder not available or read-only.
- Wrong firmware version.
- Encoder type does not support the ANR function.
- Dual recording is active.

See also

- *Configuring an iSCSI device, page 130*
- *Configuring the storage media of an encoder, page 107*
- *Configuring the ANR function, page 194*

4.9

Dual / failover recording

Intended use

A Primary VRM manages the normal recording of the cameras of your system. You use a Secondary VRM to achieve dual recording of your cameras.

Dual recording allows you to record video data from the same camera to different locations.

Dual recording is usually performed with different stream settings and recording modes. As a special case of dual recording you can configure mirrored recording: the same video signal is recorded twice to different locations.

Dual recording is realized by using 2 VRM servers managing multiple iSCSI devices that can be located at different locations.

A Secondary VRM can manage the secondary recording for multiple Primary VRMs.

The user can select between the recordings managed by the Primary VRM and those managed by the Secondary VRM. For a single camera, the user can switch over to the recordings of the Secondary / Primary VRM. The user can also display the recordings of the same camera managed by Primary VRM and Secondary VRM simultaneously.

For dual recording, you must install a Secondary VRM during Setup.

A Failover VRM is used for continuing the recording of a failed Primary VRM or a failed Secondary VRM computer.

The following graphic shows an example of a dual recording scenario:

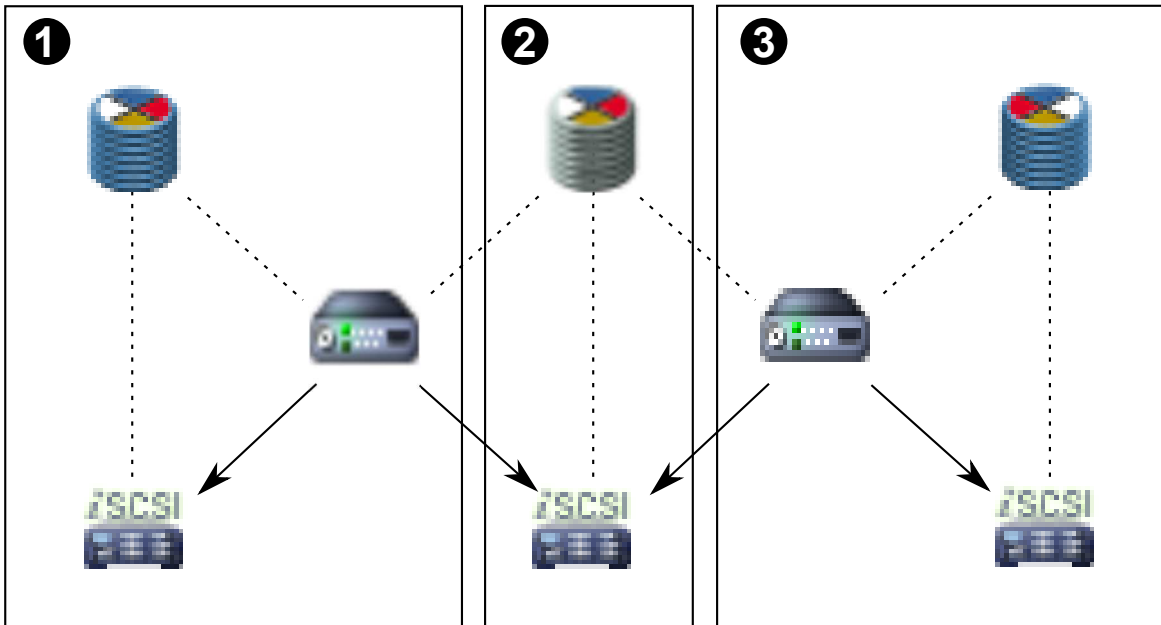

1	Site 1		Encoder
2	Central site		iSCSI storage device
3	Site 2	Control connection
	Primary VRM	➔	Video stream
	Secondary VRM		

Limitations

You cannot use dual recording together with ANR.
 Cameo SDK only supports the playback of primary recording.

See also

- *Configuring dual recording in the Camera Table, page 194*
- *Adding a Primary VRM manually, page 126*
- *Adding a Secondary VRM manually, page 126*
- *Adding a Mirrored VRM manually, page 127*
- *Adding a Failover VRM manually, page 127*
- *Cameras page, page 350*

4.10

VRM recording modes

This chapter shows graphics to illustrate the possible VRM recording modes.



List of possible VRM recording modes:

- Primary VRM recording
- Mirrored VRM recording
- Secondary VRM recording
- Failover VRM recording

For ANR recording, see chapter *Automated Network Replenishment (ANR), page 39*.

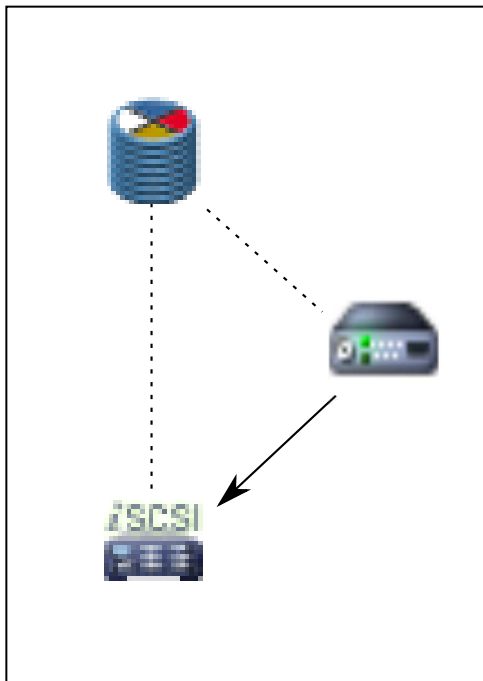



Primary VRM recording

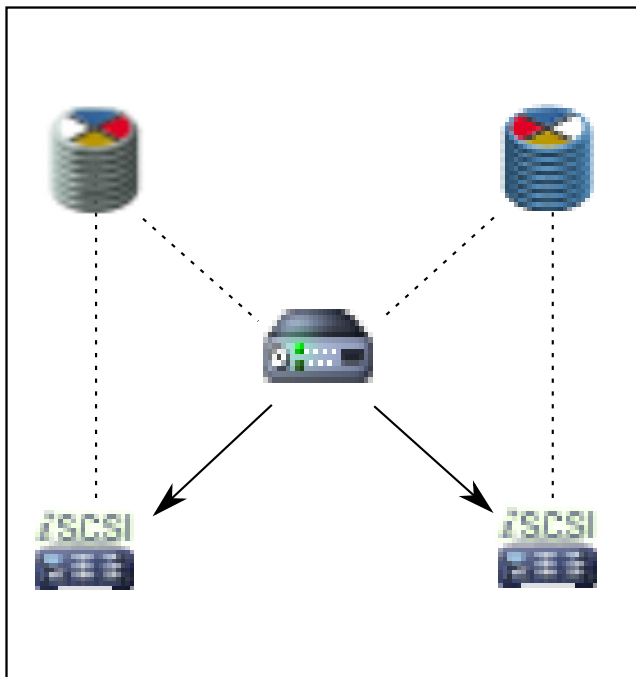

	Primary VRM	Control connection
	iSCSI storage device	→	Video stream
	Encoder		





Mirrored VRM recording

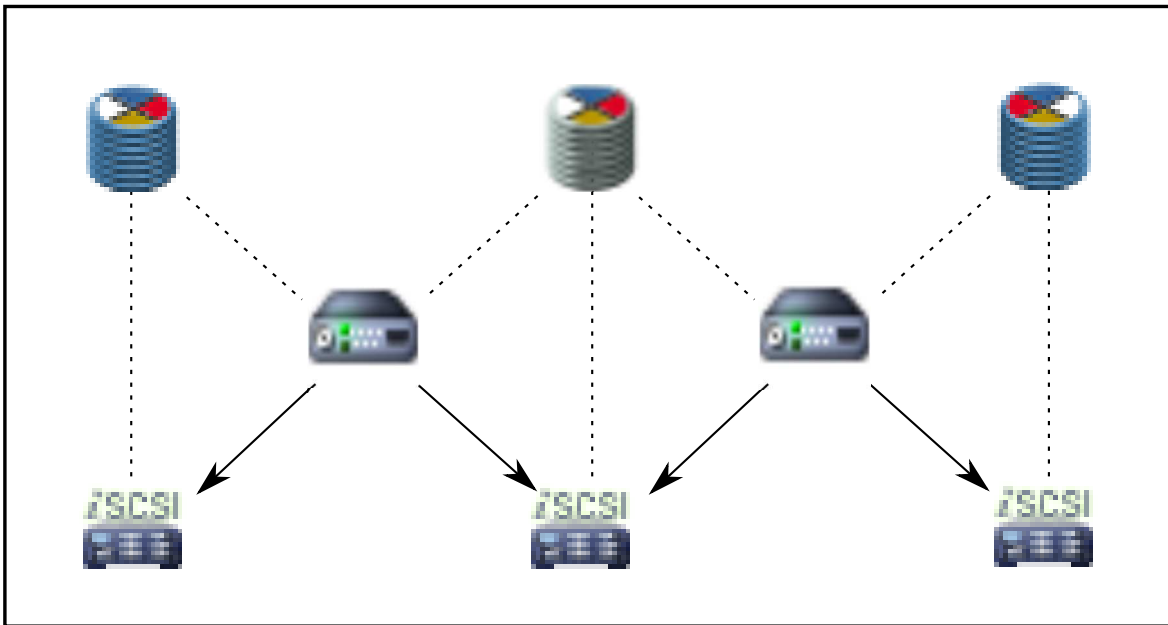

	Primary VRM		Secondary VRM
	iSCSI storage device	Control connection
	Encoder	➔	Video stream

Secondary VRM recording



	Primary VRM		Secondary VRM
	iSCSI storage device	Control connection
	Encoder	➔	Video stream

Failover VRM recording

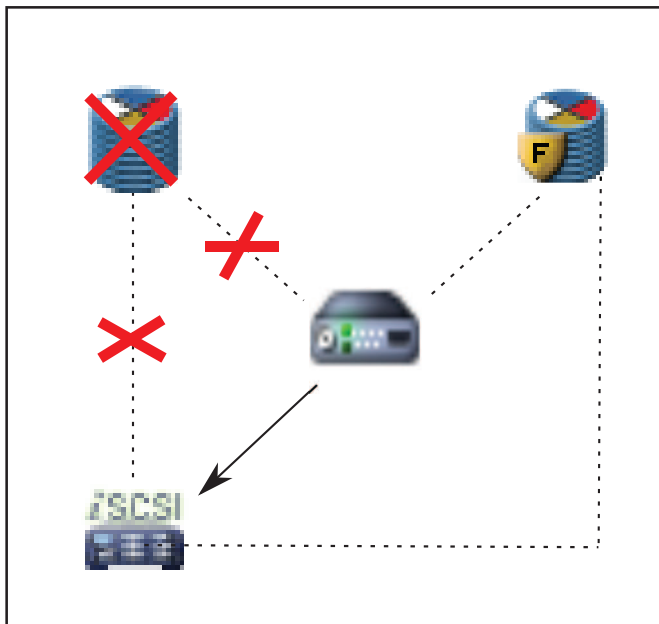

	Primary VRM		Secondary VRM
	iSCSI storage device		Primary Failover VRM
	Encoder		Secondary Failover VRM
.....	Control connection		Video stream

4.11 Playback of VRM recording sources

The following graphics show Image panes with playback from all possible VRM recording sources. Each graphic displays the storage device, the VRM instance (if available), and a section of an Image pane as example of the playback. If applicable, the recording source is indicated by an appropriate icon on the Image pane bar.

- Playback of single recording, page 44
- Playback of dual VRM recording, page 46
- Playback of Primary VRM recording with optional Failover VRM, page 47
- Playback of Secondary VRM recording with optional Failover VRM, page 49
- Automatic Network Replenishment, page 51

Playback of single recording

This Image pane is displayed when only a Primary VRM is configured. You cannot select another recording source.

: If configured for this workstation, playback is provided directly by the iSCSI storage device.

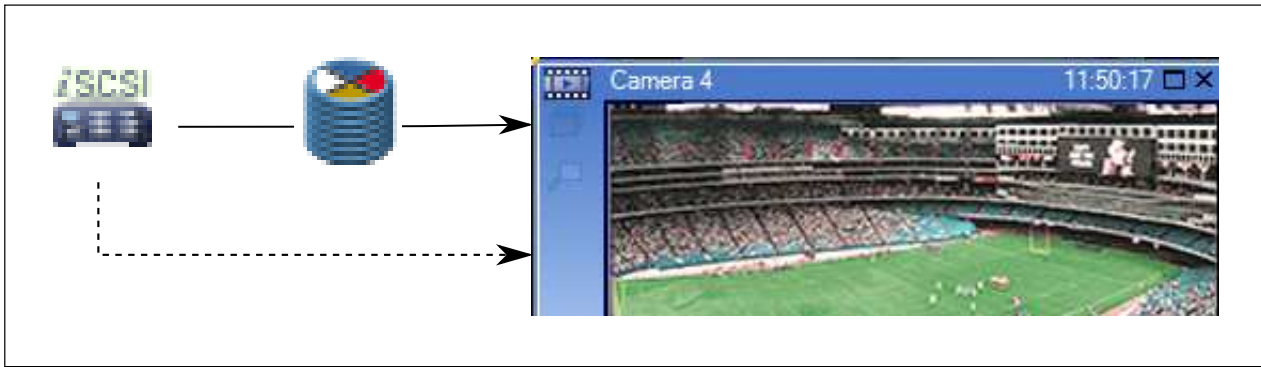





	iSCSI storage device
	Primary VRM

Playback of dual VRM recording

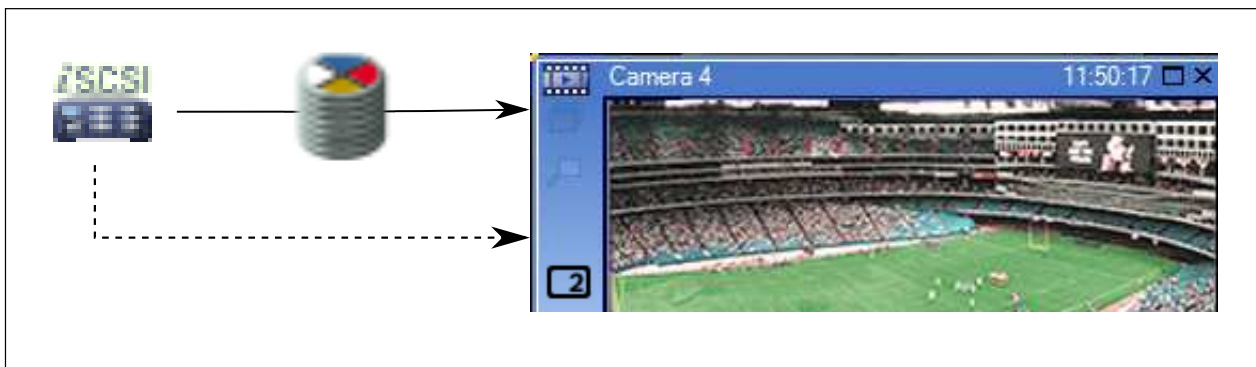
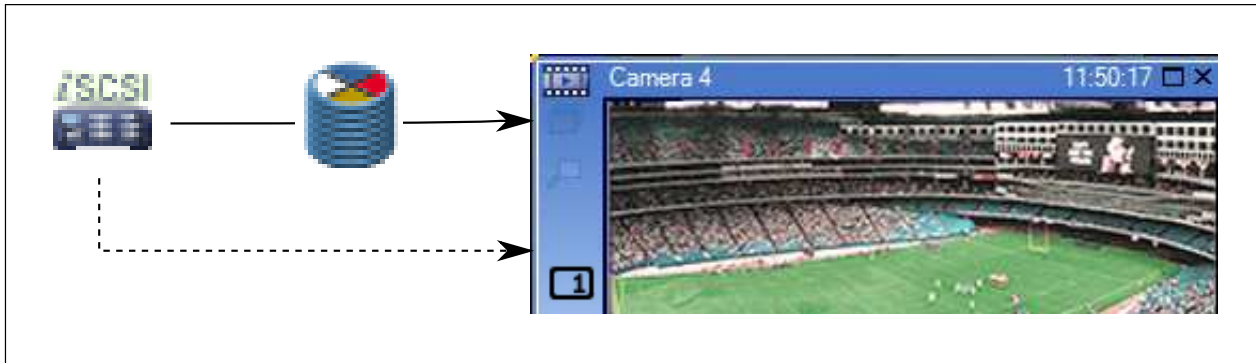
A Primary VRM and a Secondary VRM are configured. Click the recording source icon to display primary or secondary playback.

If configured for this workstation, playback is provided directly by the iSCSI storage device.



	iSCSI storage device
	Primary VRM
	Secondary VRM

Playback of Primary VRM recording with optional Failover VRM

While the Primary VRM is working, it provides playback. The Failover VRM runs in idle state. If configured for this workstation, playback is provided directly by the iSCSI storage device. If a Secondary VRM or ANR recording is configured, you can switch the recording source.

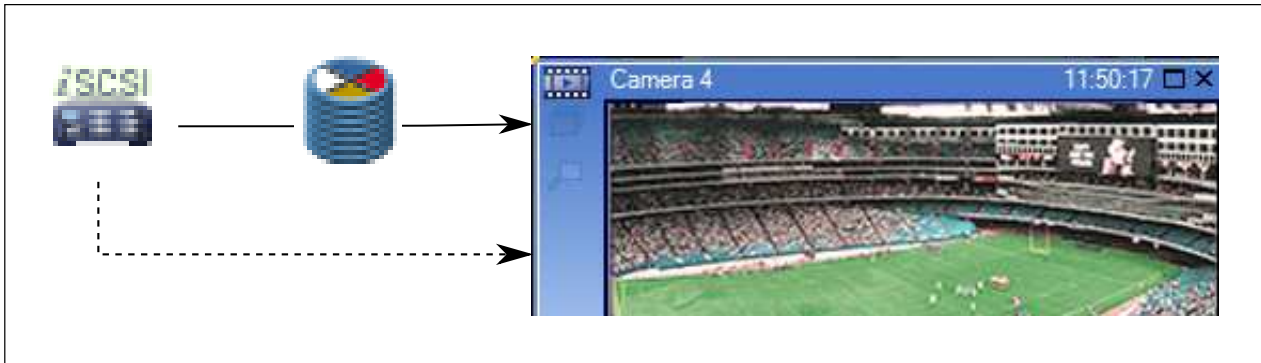

When the Primary VRM is not connected, the configured Failover VRM provides playback. Close the Image pane and display the camera again in an Image pane:

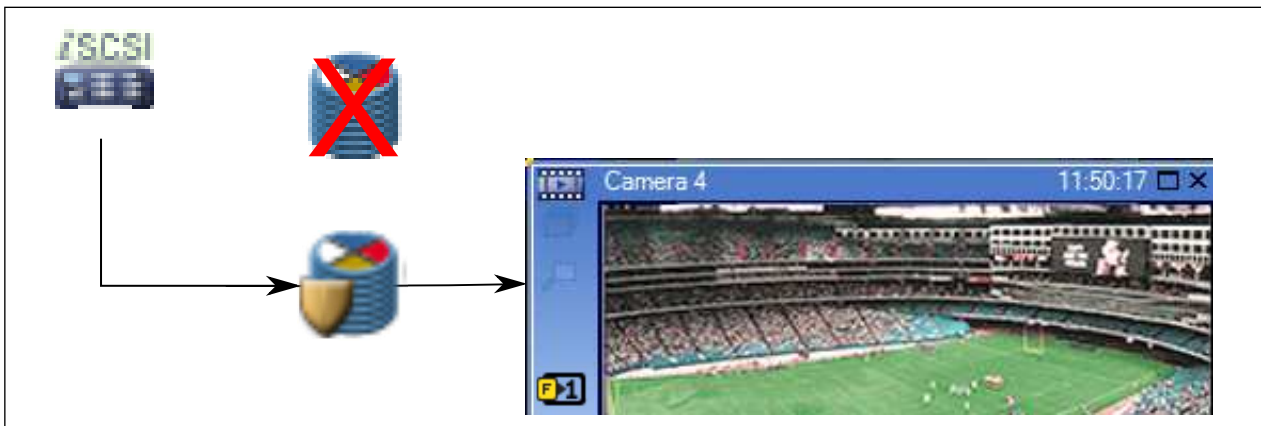

When the Primary VRM and the optional Primary Failover VRM are both not connected, the encoder provides playback. Close the Image pane and display the camera again in an Image pane:

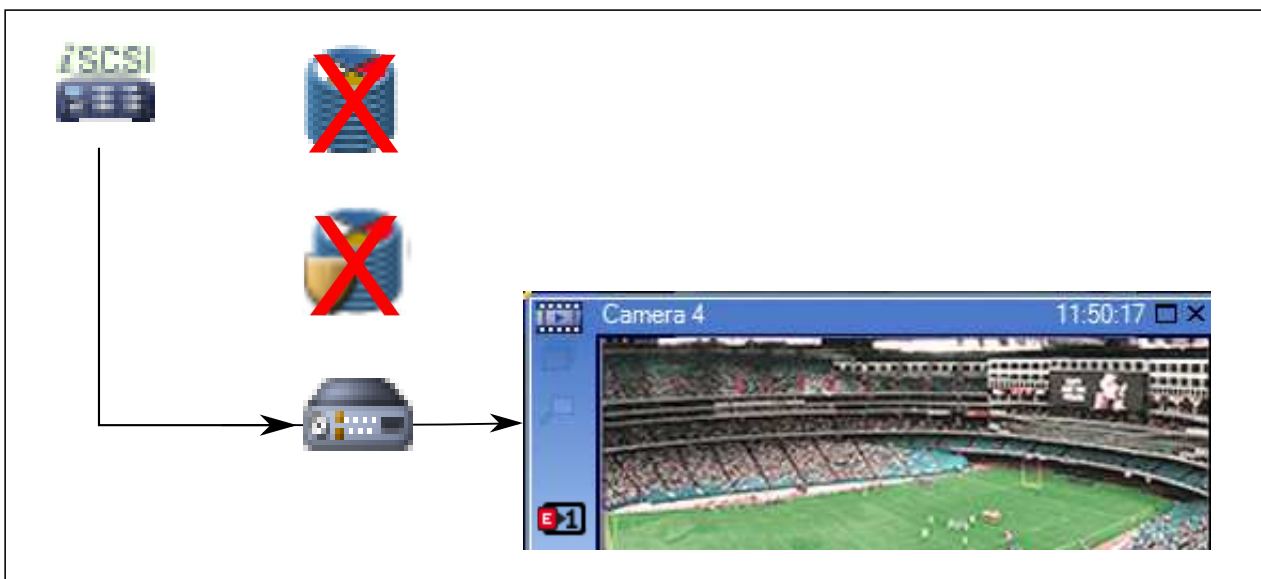

	iSCSI storage device
	Primary VRM
	Primary Failover VRM
	Encoder

Encoder playback can only access a limited recording period.

Playback of Secondary VRM recording with optional Failover VRM

While the Secondary VRM is working, it provides playback. The Failover VRM runs in idle state. If configured for this workstation, playback is provided directly by the iSCSI storage device.

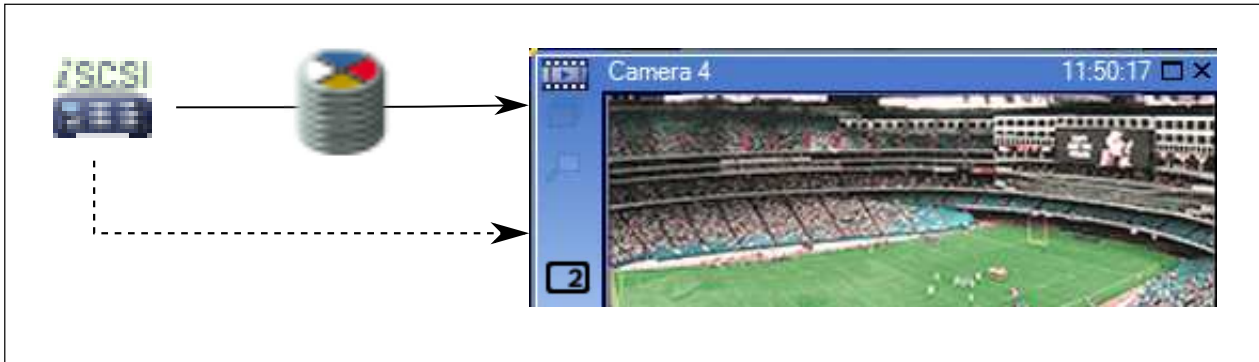

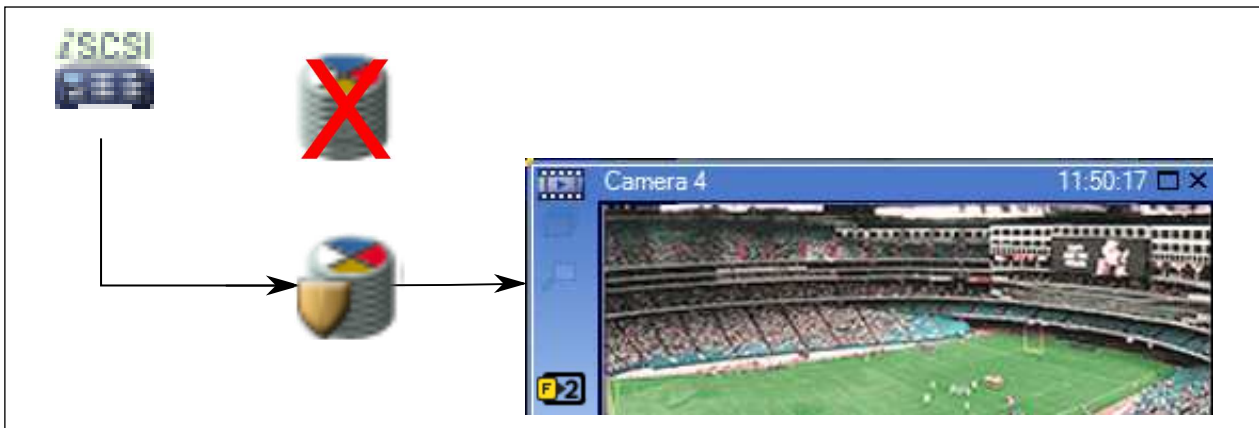

When the Secondary VRM is not connected, the configured Failover VRM provides playback. Close the Image pane and display the camera again in an Image pane:

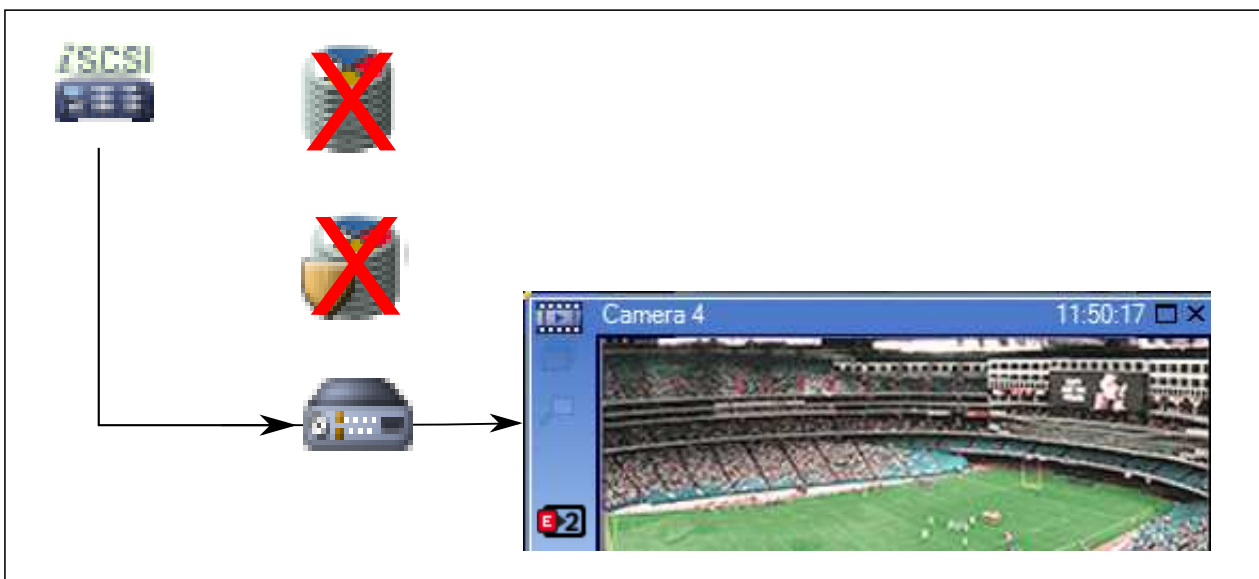

When the Secondary VRM and the optional Secondary Failover VRM are both not connected, the encoder provides playback. Close the Image pane and drag the camera again to an Image pane:







	Primary VRM
	Secondary Failover VRM
	Encoder

Encoder playback can only access a limited recording period.

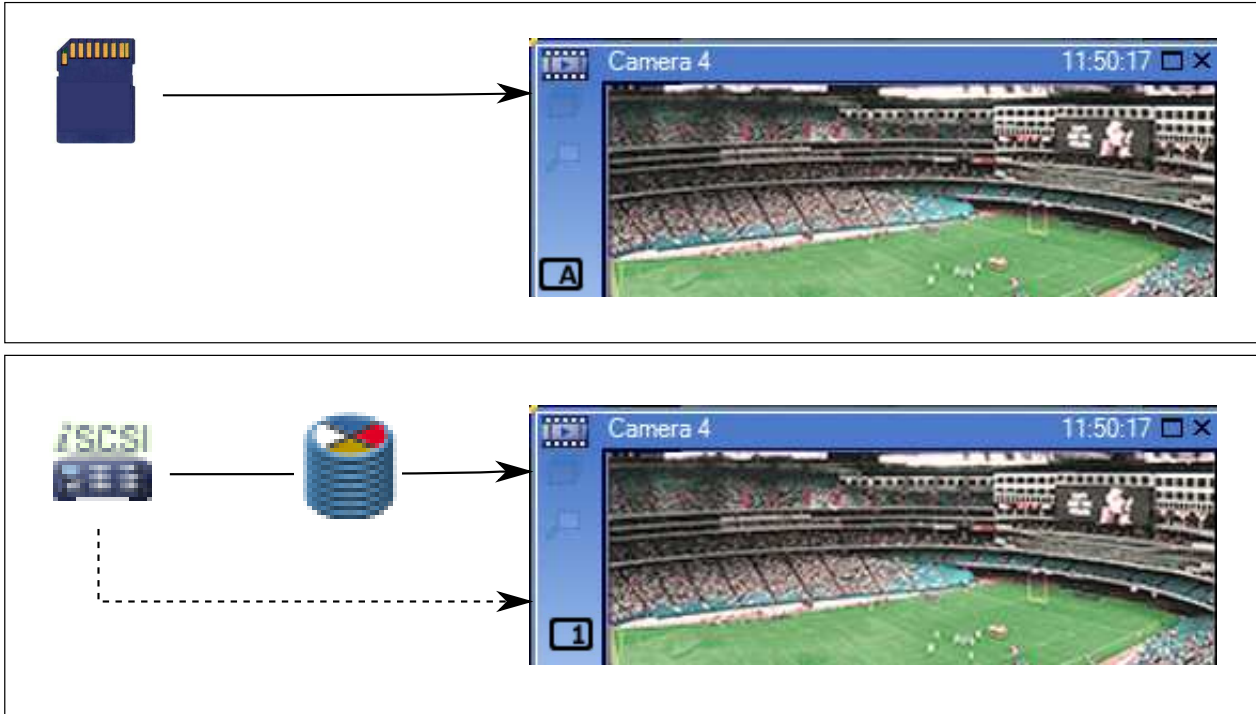
Automatic Network Replenishment

ANR is configured. Click the recording source icon to display primary playback (primary failover playback, primary encoder playback) or ANR playback. If configured for this workstation, playback is provided directly by the iSCSI storage device.



	iSCSI storage device
	Primary VRM
	SD card

4.12 Alarm handling

Alarms can be individually configured to be handled by one or more user groups. When an alarm occurs, it appears in the Alarm List of all users in the user groups configured to receive that alarm. When any one of these users starts to work on the alarm, it disappears from the Alarm List of all other users.

Alarms are displayed on a workstation’s alarm monitor and optionally on analog monitors. This behavior is described in the following paragraphs.

Alarm flow

1. An alarm occurs in the system.
2. Alarm notifications appear in the Alarm Lists of all users configured for this alarm. Alarm video is immediately displayed on configured monitors. If it is an automatically displayed alarm (auto pop-up), the alarm video is also automatically displayed on the Operator Client workstation’s alarm monitors.

If the alarm is configured as an auto-clear alarm, the alarm is removed from the Alarm List

after the auto-clear time (configured in the Configuration Client).

On analog monitors, any quad views from VIP XDs are temporarily replaced by full-screen displays.

3. One of the users accepts the alarm. The alarm video is then displayed on this user's workstation (if it is not already displayed via auto pop-up). The alarm is removed from all other Alarm Lists and alarm video displays.
4. The user who accepted the alarm invokes a workflow that can include reading an action plan and entering comments. This step is optional - requirements for workflow can be configured by the administrator.
5. Finally, the user clears the alarm. This removes the alarm from his Alarm List and alarm display.

On an analog monitor group, the monitors return to the cameras that were displayed before the alarm occurred.

Alarm Image window

1. To display alarm video, the Alarm Image window replaces the Live or Playback Image window on the monitor that has been configured for alarm display.
2. Each alarm gets a row of Image panes. Up to 5 Image panes can be associated with each alarm. These Image panes can display live video, playback video, or maps.
On an analog monitor group, each alarm can call up cameras on a row of analog monitors. The number of cameras in the row is limited by the number of columns in the analog monitor group. Monitors in the row that are not used for alarm video can be configured to either continue with their current display or to display a blank screen.
3. Higher priority alarms are displayed above lower priority alarms on both analog monitor rows and the Operator Client workstation display alarm rows.
4. If the Alarm Image window is completely full of Alarm Image rows and an additional alarm must be displayed, the lowest priority alarms "stack up" in the bottom row of the Alarm Image window. You can step through the stacked alarms with the controls at the left side of the alarm row.

You can step through the alarm stacks on analog monitor groups with control buttons in the **Monitors** window of the Operator Client workstation display. Analog monitors in alarm are indicated by red icons with blinking "LEDs".

The alarm title, time, and date can be optionally be displayed on all analog monitors, or only the first monitor in the alarm row.

5. For equal priority alarms, the administrator can configure the order behavior:
 - Last-in-First-out (LIFO) mode: in this configuration, new alarms are inserted *above* older alarms of the same priority.
 - First-in-First-out (FIFO) mode; in this configuration, new alarms are inserted *below* older alarms of the same priority.
6. An alarm's Image row can appear in the Alarm Image window in one of two ways:
 - When it is generated (auto pop-up). This occurs when the alarm priority is higher than display priority.
 - When the alarm is accepted. This occurs when the alarm priority is lower than display priority.

Auto pop-up alarms

Alarms can be configured to automatically display (pop up) in the Alarm Image window, based on the alarm priority. Each user group's live and playback displays are also assigned priorities. When alarms are received with priority higher than that of the user's display, the alarm

automatically displays its alarm row in the Alarm Image window. If the Alarm Image window is not currently displayed, it automatically replaces the Live or Playback Image window on the alarm-enabled monitor.

Although auto pop-up alarms are displayed in the Alarm Image window, they are not automatically accepted. They can be displayed on multiple users' displays simultaneously. When a user accepts an auto pop-up alarm, it is removed from all other users Alarm Lists and alarm displays.

See also

- *Configuring the pre- and post-alarm duration for an alarm, page 202*

4.13

DVR devices

This chapter gives background information on the DVR devices that you can integrate in Bosch VMS.

Some DVR models (e.g. DHR-700) support recording from encoders / IP cameras. Other DVR models support only analog cameras.

An encoder / IP camera should not be integrated into the configuration of two video systems (DVRs or video management systems).

If encoders / IP cameras are connected to a DVR which is already integrated in Bosch VMS, these encoders / IP cameras are not detected by the Bosch VMS network device scan. This holds true for the network scan started from within Configuration Client or started from within Config Wizard.

If a DVR with connected encoders / IP cameras is integrated in Bosch VMS and these encoders / IP cameras are already added to Bosch VMS, a warning is displayed. Remove these encoders / IP cameras from the DVR or from Bosch VMS.

Config Wizard does not add DVR devices with conflicting IP cameras to the configuration.

DVR devices support a limited number of simultaneous connections. This number defines the maximum number of Operator Client users that can simultaneously display videos from this DVR without black Image panes being displayed.



Caution!

Add the DVR using the administrator account of the device. Using a DVR user account with restricted permissions can result in features that are not usable in Bosch VMS, for example using the control of a PTZ camera.

DIVAR AN 3000/5000: When you delete video data from the DVR, please note that you always delete at least the full hour of video data. For example if you select a time period from 6:50 to 7:05, you will effectively delete the video data from 6:00 through 8:00.

Bosch 700 Series Hybrid and Network HD Recorders: Deletion always starts with the beginning of the recordings of all cameras that are displayed in Operator Client, and ends with the point in time that you enter.

See also

- *DVR (Digital Video Recorder) page, page 240*
- *Configuring the integration of a DVR, page 161*

4.14 Mobile Video Service

Mobile Video Service is transcoding video streams from the source to the available bandwidth of connected clients. The interfaces of the Mobile Video Service are designed to support clients on multiple platforms, for example Mobile devices (IOS; iPad, iPhone) and Windows Internet Explorer HTML client.

Mobile Video Service is based on Microsoft Internet Information Service.

One mobile service may serve several clients synchronously.

For limits refer to data sheet and the Technical Note Mobile Video Service available in the Online Product Catalog for Bosch VMS.

Internet Information Service

Configure the settings for Internet Information Service on the computer where you plan to install MVS for Bosch VMS.

Installation notes

You cannot add Mobile Video Service (MVS) in Configuration Client when the time between the Configuration Client computer and the Mobile Video Service computer is not synchronized. Please ensure that the time is synchronized between the affected computers. Install and configure Internet Information Service (IIS) before you install Mobile Video Service. If IIS is not installed, Bosch VMS Setup to install Mobile Video Service aborts.

You select the Mobile Video Service component for installation during Bosch VMS Setup.

You cannot install VRM and Mobile Video Service on the same computer.

We recommend that you do not install Mobile Video Service on the same computer where you install Management Server.

With Mobile App you can perform the following tasks:

- Displaying video
 - Live
 - Playback
- Sending live video
- Recording and sending recorded video
- Alarm recording
- Monitoring network and server

Related Topics

- *Adding a Mobile Video Service, page 167*
- *Mobile Video Service page, page 265*

4.15 Adding Video IP devices from Bosch

As of Bosch VMS version 4.5.5 and firmware version 5.70 you can add all Video IP devices from Bosch to your system. You use the **<Auto Detect>** selection for adding these devices. An encoder that you add with the **<Auto Detect>** selection, must be available in the network. The device capabilities of the encoder are retrieved and default stream qualities are applied.

Notice:

You cannot add a device with the **<Auto Detect>** selection to an NVR.

Related Topics

- *Adding a device manually, page 155*
- *Updating the device capabilities, page 138*
- *Add Encoder / Add Decoder dialog box, page 246*
- *Edit Encoder / Edit Decoder dialog box, page 247*

4.16 Region of Interest (ROI)

Intended use

Intended use of ROI is to save network bandwidth when zooming into a section of the camera image with a fixed HD camera. This section behaves like a PTZ camera.

Functional description

The ROI feature is only available for stream 2.

Fixed HD cameras provide ROI streams with SD resolution.

When a TCP connection is used in Live Mode, the encoder adapts the encoding quality to the network bandwidth. The best adapted quality never exceeds the configured quality of the stream.

In addition to that the encoder streams only the area selected by the user (through zooming and panning actions).

The usage of ROI has the following advantages:

- Decreased network bandwidth usage
- Decreased decoding performance required on the client

A user with a higher priority for PTZ control can take over the control of ROI and can change the image section. The recording of stream 2 has the highest priority. This means that a continuous recording of stream 2 makes the control of ROI impossible. If alarm recording of stream 2 is configured, you cannot control ROI when an event occurs that triggers alarm recording.

Limitations

You can use ROI only with fixed HD cameras.

You can use ROI only in Live Mode.

The ROI feature is available on the Nevada and A5 HW platform with firmware version 5.60 or higher.

Enable TCP mode for this camera to adapt the network bandwidth. The encoder adapts the encoding quality to the network bandwidth. Whenever a second client is requesting the same stream (for example for recording), the bandwidth adaptation is turned off.

Additionally the required performance of the decoding process on the client is decreased.

If stream 2 is configured to **H.264 MP SD ROI** on the **Cameras and Recording** page but not yet set on the encoder, the PTZ control does not work. Activate the configuration to set this property on the encoder.

See also

- *Cameras page, page 350*
- *Camera Permissions page, page 375*

4.17 Intelligent Tracking

Intended use

Intended use of Intelligent Tracking is to enable a camera to follow a selected object. You can configure whether the selection of an object is automatically or manually. The camera can be a PTZ camera or a fixed HD camera (only with ROI enabled).

The following 3 modes are available:

- **Off:** Intelligent Tracking is turned off.
- **Auto:** Intelligent Tracking turned on, the largest object is automatically selected for tracking, recommended use: rarely moving objects in the image.
- **Click:** User selects object to be tracked.

After selecting the object to be tracked, a PTZ camera moves to follow the object until this object leaves the visible area of the camera or the operator stops tracking.

A fixed HD camera with the Intelligent Tracking feature enabled defines a surrounding region close to the borders of the selected object and zooms into the image to display only the region. Then the region is moved according to the movement of the object.

Limitations

Intelligent Tracking can only be used for Live operations. You cannot use Intelligent Tracking later in recorded videos.

For a PTZ camera to be used for Intelligent Tracking, we recommend configuring to return to a defined preposition after a longer period of inactivity. Otherwise it can happen that a PTZ camera follows an automatically selected object and after the object having disappeared, the PTZ camera shows an irrelevant image.

4.18 Inactivity logoff

Intended use

Intended use of inactivity logoff is to protect an Operator Client or Configuration Client during the absence of the operator or administrator.

You can configure per user group that Operator Client shall be logged off automatically after a specified time period without activity.

For Configuration Client no user groups are available. The inactivity logoff setting is valid only for the **admin** user.

All operations with keyboard, mouse and CCTV keyboard affect the specified time period for inactivity logoff. Automatic activities of Operator Client do not affect the time period.

Automatic activities of Configuration Client like firmware upload or iSCSI setup prevent the inactivity logoff.

You can also configure the inactivity logoff for a Bosch VMS Web Client.

Short before an inactivity logoff, a dialog box reminds the user to actively prevent the inactivity logoff.

The Logbook records an occurred inactivity logoff.

Example

If a workstation is located in a public area, the inactivity logoff minimizes the risk that on an unattended workstation Operator Client is accessed by an unauthorized person.

An administrator group member shall logoff automatically after inactivity but a desk officer (operator group) might just watch video without operating the system and does not want an inactivity logoff.

Limitations

Client SDK activity does not support the inactivity logoff, this means that the activity of Client SDK does not affect the specified time period.

See also

- *Options dialog box, page 229*
- *Operator Features page, page 381*

4.19 Malfunction relay

Intended use

A malfunction relay is intended to switch in case of any severe system error to trigger an external alert (strobe, siren, etc.).

The user must reset the relay manually.

The malfunction relay can be one from the following list:

- BVIP encoder or decoder relay
- ADAM relay

- Intrusion panel output

Example

If something happens that severely affects the system functioning (for example a hard disk failure) or an incident occurs that endangers the security of a site (for example a failing reference image check), the malfunction relay is activated. This can for example trigger an audible alarm or can close doors automatically.

Functional description

You can configure a single relay to act as a malfunction relay. The malfunction relay gets activated automatically when an event from a set of user-defined events is triggered. Activation of a relay means that a command will be sent to the relay to close it. The subsequent “Relay Closed” event is decoupled from the command and will only be generated and received if the relay state is physically changed! For example a relay being closed before, will not send this event.

Apart from being automatically triggered by the set of user-defined events, the malfunction relay is treated like any other relay. Therefore, the user is able to deactivate the malfunction relay in Operator Client. The Web Client also allows deactivating the malfunction relay. Because the regular access permissions apply to the malfunction relay as well, all clients need to consider the permissions of the logged-on user.

See also

- *Adding a malfunction relay, page 182*
- *Malfunction Relay dialog box, page 346*

4.20

Text data

Intended use

The operator can search for text data to find the corresponding recordings. The text data must be stored in the Logbook.

Text data is delivered by systems like foyer card readers, automatic teller machines or virtual inputs. Text data contains textual transaction data like account numbers and bank routing codes.

Functional description

Text data of a device is recorded together with the corresponding video data.

Limitations

For searching recordings with text data, the text data must be configured to be stored in the Logbook.

The encoder for which you configure the recording text data function, must have firmware version 5.92 or later.

The text data of maximum 32 different devices can be recorded synchronously for one camera. Maximum 3000 bytes of text data can be stored on an encoder per event.

If you see problems with Logbook searches, display of additional data, or CSV exports of Logbook search results, the reason can be that the additional text data contains non-printable characters, for example x00-x1F.

See also

- *Triggering alarm recording with text data, page 202*
- *Text Data Recording dialog box, page 363*

4.21 Allegiant CCL commands

You use CCL commands for switching IP cameras or encoders to IP decoders both configured in Bosch VMS. You cannot use CCL commands to directly control analog cameras or the Allegiant matrix itself.

The Allegiant CCL emulation starts an internal Bosch VMS service that translates CCL commands of the Matrix Switch into Bosch VMS. You configure a COM port of the Management Server to listen to these CCL commands. The CCL emulation helps to exchange existing Allegiant devices with Bosch Video Management System or to use Bosch Video Management System with applications that support the Allegiant CCL commands. Old Allegiant hardware configured in Bosch VMS cannot be controlled with these commands.

4.22 Offline Operator Client

With the feature of the Offline Operator Client the following use cases are possible:

- Operator Client continues operation for Live, Playback and Export without connection to the Management Server computer.
- If a workstation was connected once to the Management Server computer, it can log on offline any time with any user.

For Offline Mode Bosch VMS must have version 3.0 or later.

If an Operator Client workstation is disconnected from the Management Server computer, it is possible to continue working. Some main functions are still available, for example live and playback video.

As of Bosch VMS V5.5 an Operator Client workstation can work offline with a configuration of Bosch VMS V5.0.5.

Caution!

When a password change on the Management Server occurs during the period when Operator Client is offline, this password change is not propagated to this Operator Client. When Operator Client is online, the user must log on using the new password.

When Operator Client is offline, the user must again use the old password for logon. This is not changed until a new configuration is activated and transferred to the Operator Client workstation.

Caution!

When a camera is called up for display in an analog monitor group with a workstation connected Bosch Intuikey keyboard, and the workstation is offline, the keyboard does not send an error tone.

4.22.1 Working with Offline Mode

When Operator Client is disconnected from a Management Server, a respective overlay icon is displayed in the Logical Tree on the disconnected Management Server. You can continue working with Operator Client even if the disconnection lasts longer, but some functions are not available.

If the connection to the Management Server is reestablished, a respective overlay icon is displayed.

If a new configuration on a Management Server has been activated, a respective icon is displayed in the Logical Tree on the icon of the affected Management Server and a dialog box is displayed for some seconds. Accept or refuse the new configuration.

If your Operator Client instance is scheduled to log off at a specific point in time, this logoff occurs even when the connection to the Management Server is not reestablished at this point in time.

When a user of Operator Client logs on using Server Lookup in offline state, the Server List of the last successful logon is displayed. Offline state here means that the Operator Client workstation does not have a network connection to the server containing the Server List.

Functions not available during disconnection

When disconnected from Management Server the following functions are not available in Operator Client:

- Alarm List:
This includes handling alarms. The alarm list is empty and will automatically be filled on reconnection.
- Allegiant:
The trunk line handling is not available. In earlier versions, Allegiant cameras were automatically closed with a message-box when a trunk line handling was unavailable. With Bosch VMS V3.0 we will show a more user friendly Image pane informing the user about the impossibility to display this camera right now.
- AMG:
It is not possible to drag cameras on the AMG control. The control is disabled and will automatically be enabled on reconnection.
- PTZ priorities:
Without a connection to Management Server , an offline Operator Client can connect a PTZ camera as long as the PTZ camera itself is not locked. The dome priorities will automatically be updated on reconnection.
- Input:
Input cannot be switched.
- Logbook:
The Logbook is not available and cannot be opened. An opened Logbook search window is not closed automatically. Existing search results can be used and exported.
- Operator Client SDK:
Operator Client SDK functions with IServerApi cannot be processed.
Creating a RemoteClientApi is not possible.
Some methods that are only available at client API do not work, for example ApplicationManager (try GetUserName()).
- Password change:
The operator is not able to change his password.
- Relay:
Relays cannot be switched.
- Server Script:
The server methods of the IServerApi will be processed but cannot be sent to the Client which are:
 - AlarmManager
 - AnalogMonitorMananger
 - CameraManager
 - CompoundEventManager
 - DecoderManager
 - DeviceManager
 - DomeCameraManager
 - EventManager
 - InputManager
 - LicenseManager
 - Logbook

- MatrixManager
- RecorderManager
- RelayManager
- ScheduleManager
- SendManager
- SequenceManager
- VirtualInputManager
- State overlays:
No state overlays of cameras, inputs or relays are available.

States of Operator Client

A Bosch VMS Operator Client gives you a visual and textual feedback of its states.

Following Operator Client states are possible:

- 

The Operator Client is connected to the Management Server.
- 

The Operator Client is not connected to the Management Server. One reason can be a physical disconnection from the Management Server to the network.
- 

This state can only be displayed after a reestablished connection to the Management Server. All affected functions are back, but the configuration of the Operator Client is outdated due to a newer configuration available in the system. Log on again to update the configuration.
- 

This state icon is displayed when the Management Server has an earlier Bosch VMS version than the Operator Client workstation.

Device state overlay

The device states (recording dot, too noisy, too dark, ...) are processed by the Management Server. On disconnection between Client and Server the states cannot be updated in the Client. A new state overlay will give you a visual feedback that all device states are not available at the moment. If the client has an established connection to the server again, the state overlays are updated automatically.

-  State unknown

The state overlay of a device in the Logical Tree or on a map when client is disconnected from the Management Server computer.

Reasons for disconnection

Reasons for disconnection between Operator Client and Management Server can be:

- Physical connection is broken.
- Password of logged on user has changed during offline time.
- Management Server has given away floating workstation license to another online Operator Client while the now disconnected Operator Client was offline.
- Operator Client and Management Server have different versions (Management Server earlier than version 5.5).

4.23 Version independent Operator Client

For Compatibility Mode both Operator Client and Management Server must have a version later than 5.5.

A user of Operator Client can successfully log on to a Management Server where a previous software version is running.

If the server provides a newer configuration than available on the Operator Client workstation, this configuration is automatically copied to the Operator Client workstation. The user can decide to download the new configuration.

Operator Client provides a reduced feature set and is connected to this Management Server. The following Management Server related features are available after logon to a Management Server with a previous version:





- User preferences
- Start manual recording
- Display of device states
- Toggling relay states
- Searching the Logbook
Search for events is not possible.
- Server Lookup
- Remote export

4.23.1 Working with Compatibility Mode

This feature is available in versions later than 5.5.

A Bosch VMS Operator Client gives you a visual and textual feedback of its states.

Following Operator Client states are possible:

-  The Operator Client is connected to the Management Server.
-  The Operator Client is not connected to the Management Server. One reason can be a physical disconnection from the Management Server to the network.
-  This state can only be displayed after a reestablished connection to the Management Server. All affected functions are back, but the configuration of the Operator Client is outdated due to a newer configuration available in the system. Log on again to update the configuration.
-  This state icon is displayed when the Management Server has an earlier Bosch VMS version than the Operator Client workstation.

4.24 ONVIF events

Intended use

Intended use is the mapping of ONVIF events to Bosch VMS events. ONVIF events can then trigger Bosch VMS alarms and recording.

You can define default event mappings valid only for a specific ONVIF device, for all ONVIF devices of the same manufacturer and model, or for all ONVIF devices of the same manufacturer. Default event mappings are automatically assigned to all affected ONVIF encoders that are added using the Bosch VMS Scan Wizard or are added manually.

When you add an ONVIF encoder to the Bosch VMS configuration without a connection to this ONVIF encoder, no event mappings are assigned. You can update such an ONVIF encoder with event mappings from an ONVIF encoder of the same manufacturer and/or model that you already have added.

You define event mappings specific for each of the following sources:

- ONVIF encoder
- Cameras of this ONVIF encoder
- Relays of this ONVIF encoder
- Inputs of this ONVIF encoder

Example

In an ONVIF camera a motion detection event occurs. This event shall trigger a **Motion Detected** event in Bosch VMS.

To achieve this, you configure for this ONVIF camera:

- ONVIF topic (`MotionDetection`)
- ONVIF data item (`motion`)
- ONVIF data type (`boolean`)
- ONVIF data value (`true`)

Note: It is not sufficient to only configure the **Motion Detected** event. Please configure also the **Motion Stopped** event. You always must configure a pair of events.

Import or export of a Mapping Table

You can export a Mapping Table on a computer where you have created it and import this Mapping table on another computer where the required mapping table is not available.

Troubleshooting

You can create log files for troubleshooting.

See also

- *Configuring ONVIF events, page 143*
- *Enabling logging for ONVIF events, page 394*
- *ONVIF Encoder Events page, page 325*

4.25

Viewing modes of a panoramic camera

This chapter illustrates the viewing modes of a panoramic camera which are available in Bosch VMS.

The following viewing modes are available:

- Circle view
- Panorama view
- Cropped view

Panorama and cropped view modes are created by the dewarping process in Bosch VMS. Edge dewarping is not used.

The administrator must configure the mounting position of a panoramic camera in Configuration Client.

You can resize the Image pane of a camera as required. The Image pane ratio is not restricted to the 4:3 or 16:9 aspect ratio.

See also

- *Configuring the mounting position of a panoramic camera, page 112*

4.25.1 360° panoramic camera - floor- or ceiling mounted

The following figure illustrates the dewarping of a 360° camera which is floor- or ceiling mounted.

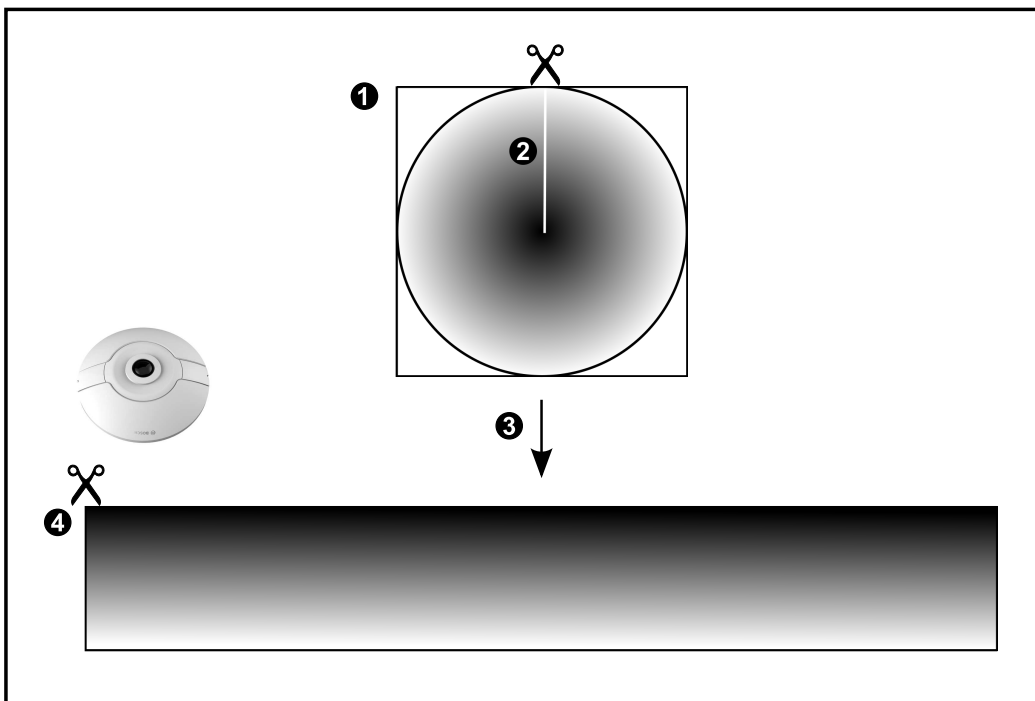
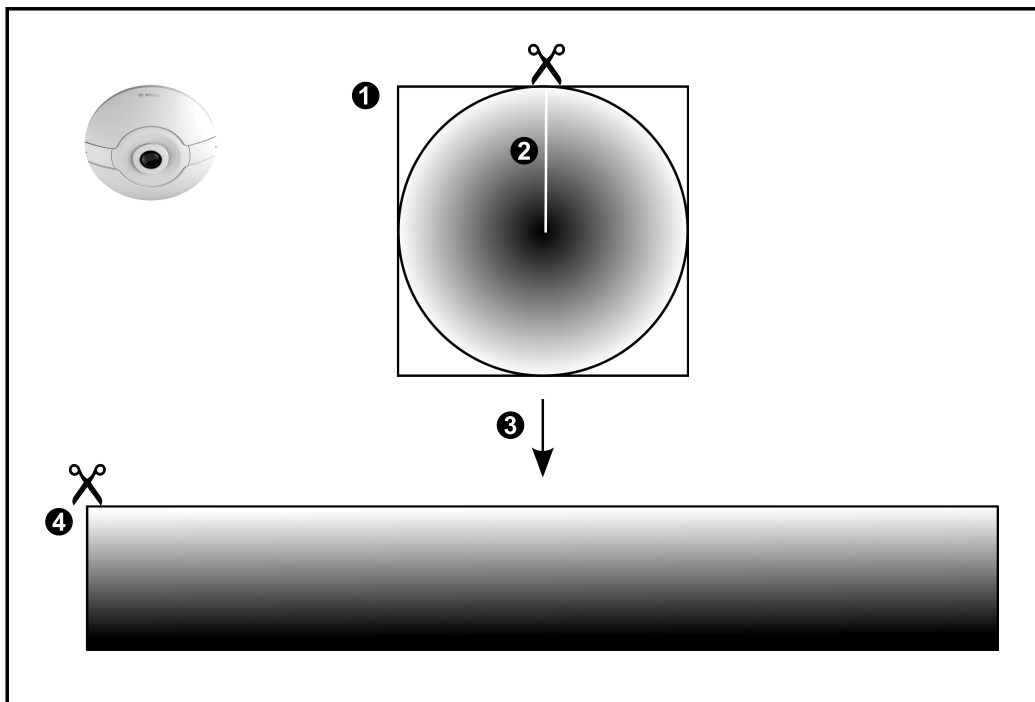

1	Full circle image	3	Dewarping
2	Snipping line (operator can change its position when not zoomed in)	4	Panorama view

4.25.2 180° panoramic camera - floor- or ceiling mounted

The following figure illustrates the dewarping of a 180° camera which is floor- or ceiling mounted.

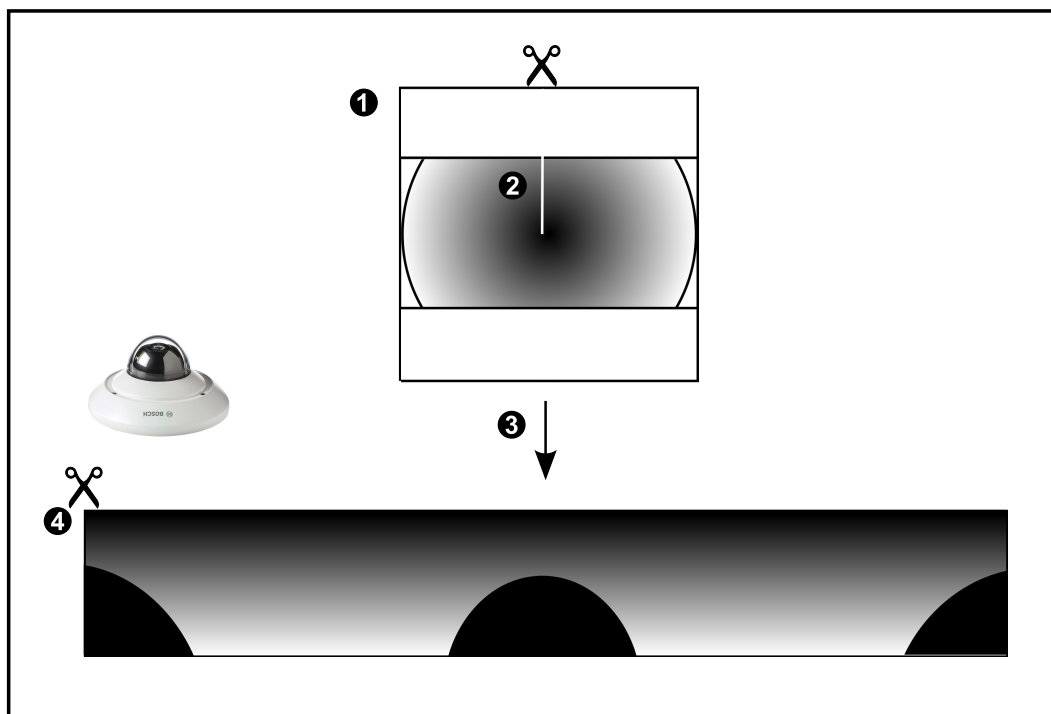
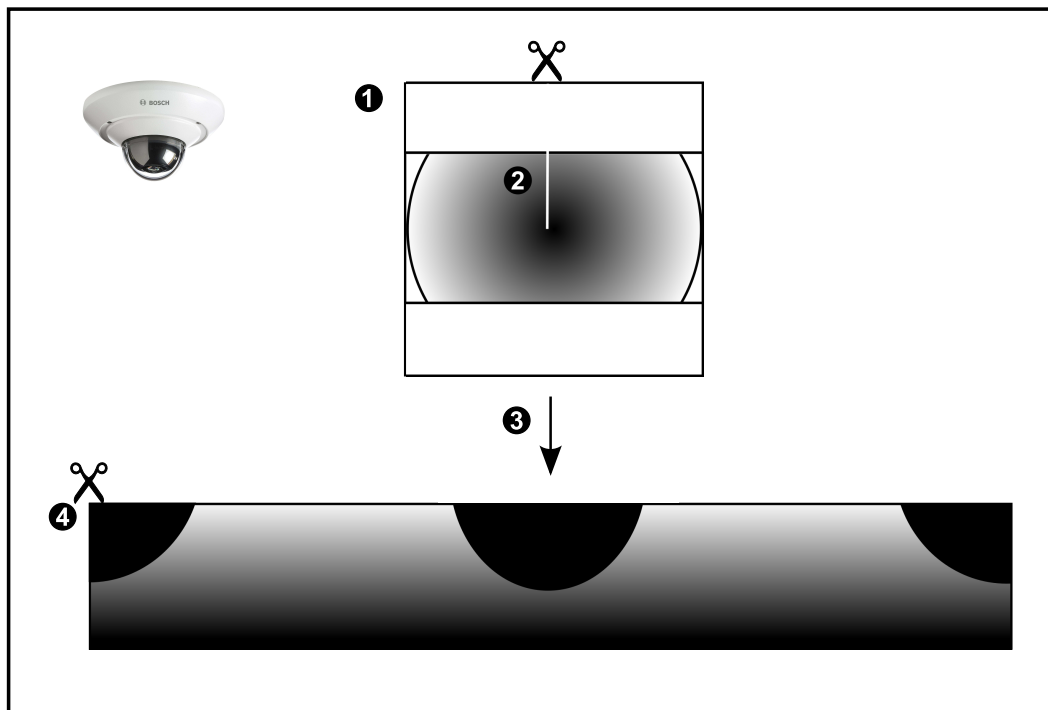

1	Full circle image	3	Dewarping
2	Snipping line (operator can change its position when not zoomed in)	4	Panorama view

4.25.3

360° panoramic camera - wall mounted

The following figure illustrates the dewarping of a 360° camera which is wall mounted.

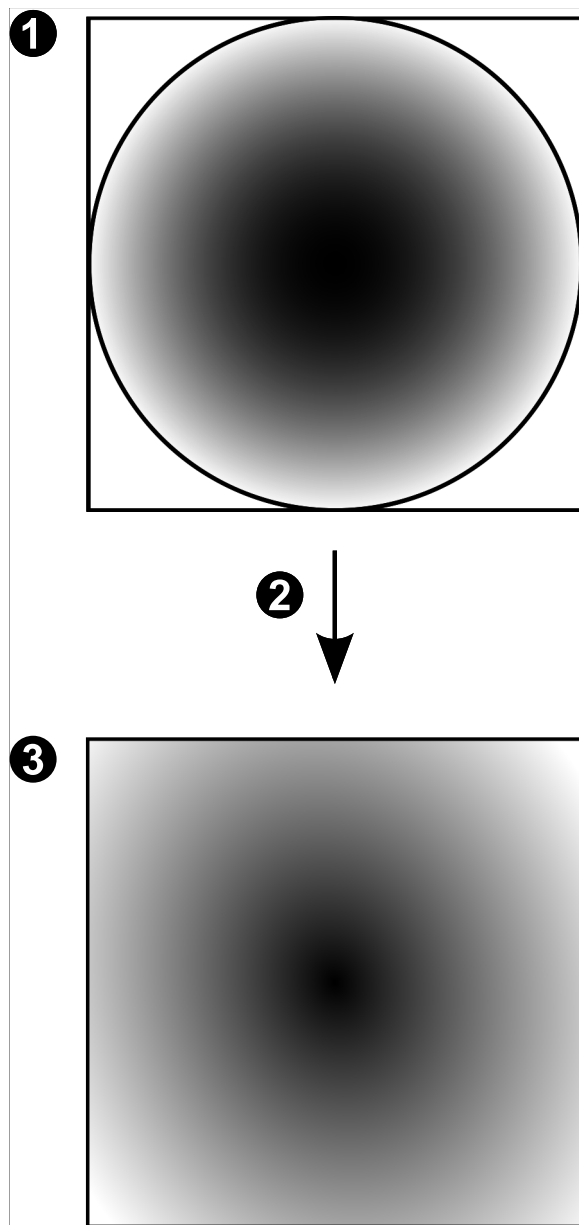

1	Full circle image	3	Panorama view
2	Dewarping		

4.25.4 180° panoramic camera - wall mounted

The following figure illustrates the dewarping of a 180° camera which is wall mounted.

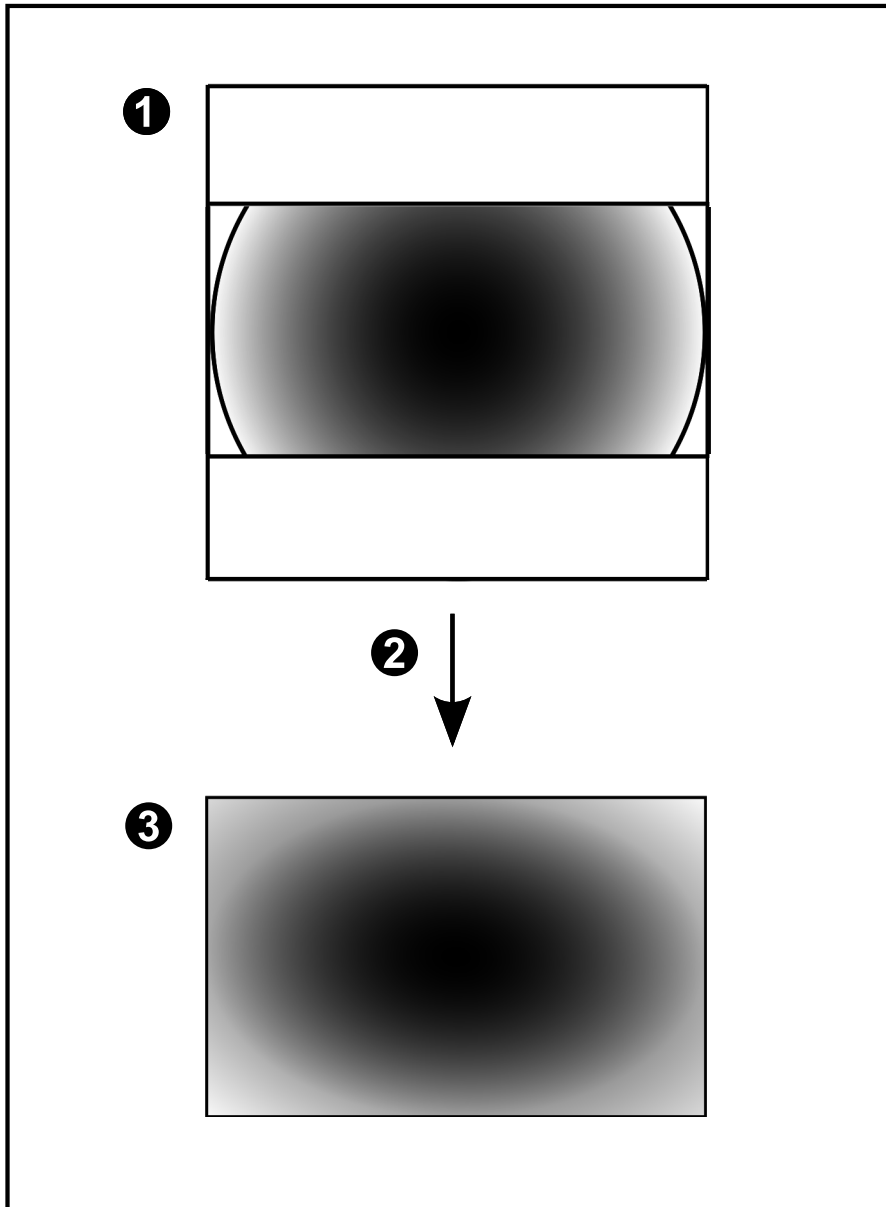

1	Full circle image	3	Panorama view
2	Dewarping		

4.25.5 Cropped view on a panoramic camera

The following example figure illustrates the cropping of a 360° camera which is floor- or ceiling mounted.

The rectilinear section used for cropping is fixed. You can change the section in the cropped Image pane using the available PTZ controls.

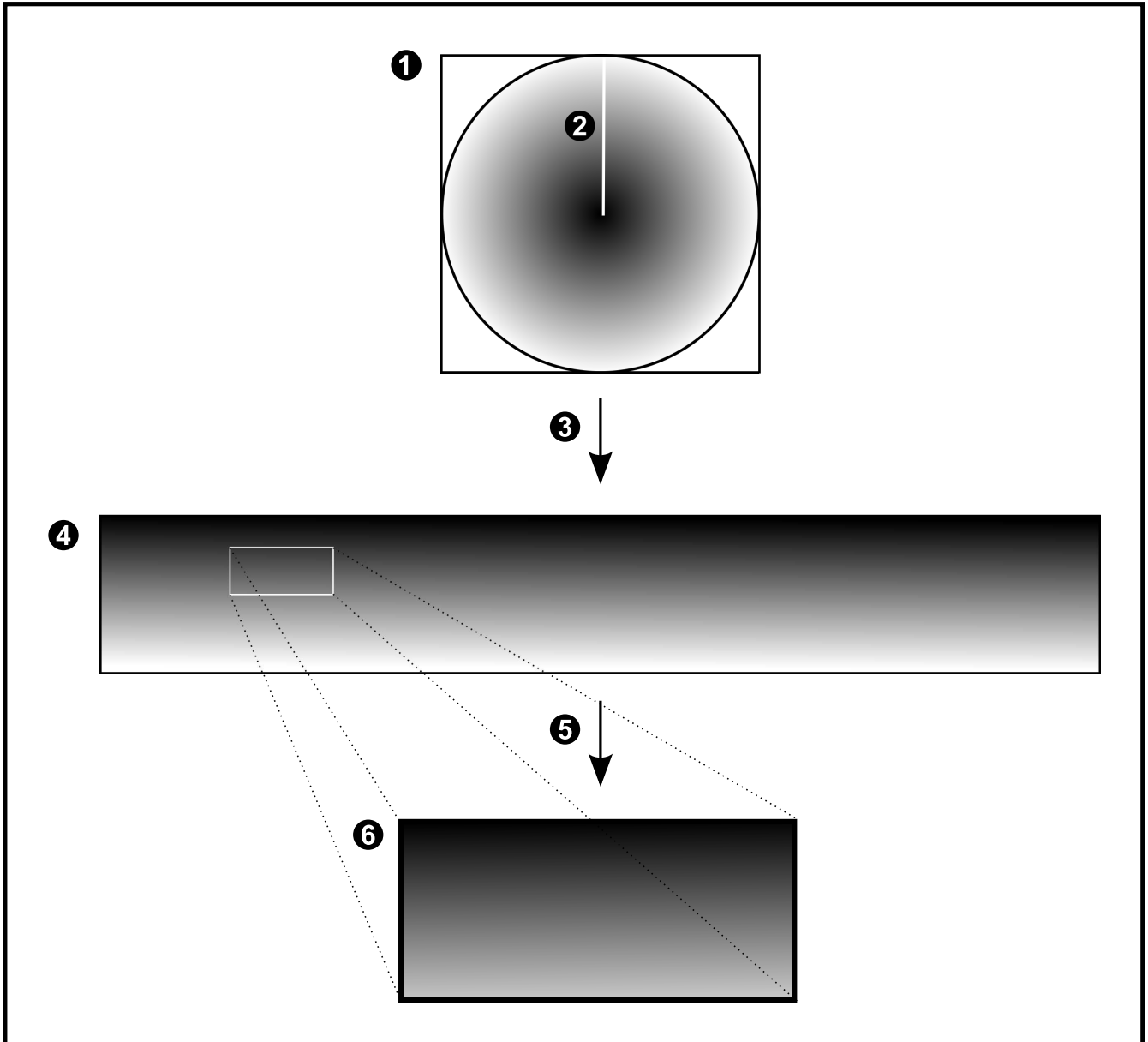

1	Full circle image	4	Panorama view
2	Snipping line (operator can change its position when not zoomed in)	5	Cropping
3	Dewarping	6	Cropped Image pane



4.26 Server-based analytics

The user of Operator Client can display the Ganetec analytics viewer application in the Live Image window. This analytics viewer application displays the results of video analytics, for example face detection. The video analytics is performed on the Bintelan Analytics Platform from Ganetec.

With Bintelan Analytics Platform, the following analytics algorithms are available:

- Face detection
- Face recognition
- Number plate detection
- Number plate recognition

Perform the following steps to configure video analytics:

1. Install the analytics viewer application of the video analytics on each Bosch VMS workstation to be used for analytics. Take a note containing the path to the analytics viewer application.
For detailed information on installing the analytics viewer application, see: *Installing the analytics viewer application, page 69*.
2. Add the cameras to the Device Tree that you want to use as analytics cameras. These cameras are automatically retrieved when the Bintelan Analytics Platform connects with your Bosch VMS Management Server.
3. Add a video analytics device  to the Device Tree of Configuration Client.
For detailed information on adding a video analytics device, see: *Adding a video analytics device, page 167*.
4. In the video analytics device, configure the path to the analytics viewer application. A default path of the analytics viewer application is pre-configured.
5. Configure the IP address of the Bintelan Analytics Platform.
6. Use the Bintelan Bosch Client application on the Bintelan Analytics Platform for connecting with Bosch VMS Management Server.
Type in the IP address of this Management Server.
7. Add the video analytics device  to the Logical Tree.
8. Configure an alarm for the **External Data** event for the desired video analytics cameras.
9. The user of Operator Client drags the video analytics device to an Image pane.
10. When an alarm occurs, an external data alarm entry is displayed in the Alarm List.
11. The user selects this entry in the Alarm List.
An image with the matched person or object is displayed in the analytics viewer application.

The following graphic shows an example of a server-based analytics scenario:

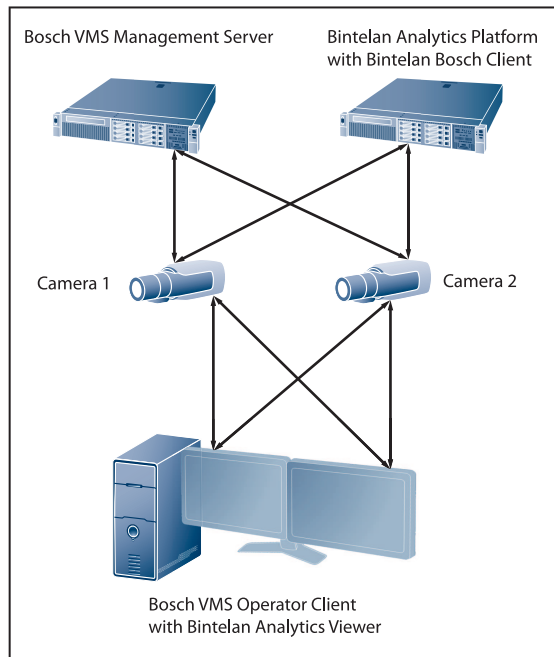

The Bintelan Analytics Platform must be configured properly to be able to connect with Bosch VMS.

You must install the analytics viewer application on each Operator Client workstation used for video analytics. Additionally configure the IP address of the Bintelan Analytics Platform in Configuration Client and the IP address of the Bosch VMS Management Server in the Bintelan Analytics Platform.

You configure the analytics viewer application in the Device Tree of Configuration Client.

See also

- *Adding a video analytics device, page 167*
- *Installing the analytics viewer application, page 69*

4.26.1 Installing the analytics viewer application

For displaying the Ganetec analytics viewer application, the software must be installed in the directory configured in Configuration Client.

For installation, you need the `BintelanClient_BoschAlarmViewer.exe` from the Ganetec Web page or from the Bosch Online Product Catalog.

Perform the installation on each Operator Client workstation where you want to use the analytics viewer application.

To install:

1. Double-click the Setup.
2. Follow the instructions on the screen.

Note: The installation directory for the analytics viewer application must be below
`%ProgramFiles(x86)%\VideoAnalytics.`

4.27 Verification of authenticity

The user of Operator Client can verify the authenticity of recordings. The authenticity of exports is automatically verified.

The administrator must follow these steps for ensuring an unbroken certificate chain. For large systems (>30 cameras) we recommend the following procedure:

- Let your issuing certificate authority (CA) issue a certificate for each encoder.

- Upload the issued certificate (including private key) in a secure way on each encoder.
- Install the CA certificate on the Operator Client workstations where you want to perform authenticity verification or on other computers where you want to perform exports.

For small systems (<30 cameras) we recommend the following procedure:

- Download the `HTTPS Server` certificate from each encoder.
- Install these certificates on the Operator Client workstations where you want to perform authenticity verification.

Ask the IT support of your company for details.

For activating the secure verification of authenticity, the administrator must perform the following steps:

- Activate the authentication on each desired camera.
- For large systems: Upload and assign the appropriate certificate to each desired camera.
- For small systems: Download a certificate from each encoder. Install the certificates allowing verification on a workstation.

Limitations

Firmware version 6.30 or later is required.

We recommend verifying the authenticity of maximum 4 cameras at the same time.

The user of Operator Client cannot verify the authenticity of live video.

Note: Do not change the certificate when recording is running. If you have to change the certificate, first stop the recording, change the certificate, and start recording again.

For verifying the authenticity of a recording, this recording is replayed in a background process with maximum speed. In networks with low bandwidth the playback can be slow. The verify process can then take as long as the time period selected for verifying. Example: You select a time period of 1 hour. The verifying process can last up to 1 hour.

The user can only verify that a recording is authentic. If the verification process is not successful, this does not necessarily mean that the video has been manipulated. Many other reasons can be responsible for the failure, for example a manual deletion. The user of Operator Client cannot distinct between an intended change of the recording or fraudulent manipulation.

Video authentication deals solely with methods of validating the authenticity of video. Video authentication does not deal with the transmission of video, or data, in any way.

The watermark feature for verifying authenticity in earlier Bosch VMS versions is replaced. The new authenticity verification is automatically available after upgrade to the latest Bosch VMS version. Authenticity checks that were successful in the past, can now not be verified because these recordings do not contain the required extended information.

Verifying authenticity is not supported in the following cases:

- Transcoding
- Local recording
- VSG
- Digital Video Recorder
- Bosch Recording Station
- ANR

See also

- *Configuring the authentication, page 146*
- *Downloading a certificate, page 146*
- *Installing a certificate on a workstation, page 147*

5 Supported hardware



Caution!

Do not connect a device to more than one Bosch VMS! This can lead to recording gaps and other undesired effects.

You can connect the following hardware to Bosch VMS:

- Mobile video clients like iPhone or iPad via DynDNS
- Various IP cameras, encoders and ONVIF cameras (live only or via Video Streaming Gateway)
Connected via network
- Live only encoders with local storage
Connected via network
- iSCSI storage devices
Connected via network
- VIDOS NVR computer
Connected via network
- Analog cameras
Connected to encoders, BRS / DiBos devices
- Decoders
Connected via network
- Analog monitors
Connected to a decoder, to a Bosch Allegiant matrix, to a Bosch VMS Client workstation
- BRS / DiBos devices (see the data sheet for Bosch VMS for supported software versions)
Connected via network
- Bosch Allegiant matrix (Firmware version: 8.75 or greater, MCS version: 2.80 or greater)
Connected to a COM port of the Management Server or to a remote computer and to an IP encoder on the network.
- KBD-Universal XF keyboard
Connected to a USB port of a Bosch VMS workstation.
- Bosch IntuiKey keyboard
Connected to the COM port of a Bosch VMS workstation (Firmware version: 1.82 or greater) or to a hardware decoder (VIP XD).
If you connect the keyboard to a workstation, the user can control the complete system with the keyboard. If you connect the keyboard to a VIP XD decoder, the user can only control analog monitors with the keyboard.
- SMS device
Connected to a COM port of the Management Server
- SMTP E-mail server
Connected via network
- POS
Connected via network
- ATM
Connected via network
- Network monitoring device
Connected via network
- I/O modules
Connected via network
Only ADAM devices are supported.

All devices connected via network are connected to a switch. The computers of the Bosch VMS are also connected to this device.

5.1 Installing hardware

Bosch VMS supports the following hardware components:

- KBD-Universal XF keyboard
 - Bosch IntuiKey keyboard
 - Bosch Allegiant matrix with cameras and monitor: Connected to a COM port of one of the computers of the network and to IP encoders connected to the network
 - Encoders with analog cameras
 - Local storage encoders
 - IP cameras and IP AutoDomes
 - Monitors connected to a decoder (analog monitor groups for alarm processing are possible)
 - DiBos Systems with cameras
 - DVR Systems with cameras
 - ATM / POS devices
 - I/O modules
- Only ADAM devices are supported.

5.2 Installing a KBD Universal XF keyboard

Refer to the Instructions Manual delivered with your KBD-Universal XF keyboard available on the online product catalog.

Install manufacturer's driver before attaching the keyboard.

Documentation and software for Bosch Security Systems products can be found in the online product catalogue as follows:

- ▶ Open any browser > enter www.boschsecurity.com > select your region and your country > start a search for your product > select the product in the search results to show the existing files.

You can connect the following hardware to Bosch VMS:

- Mobile video clients like iPhone or iPad via DynDNS
- Various IP cameras, encoders and ONVIF cameras (live only or via Video Streaming Gateway)
 - Connected via network
- Live only encoders with local storage
 - Connected via network
- iSCSI storage devices
 - Connected via network
- VIDOS NVR computer
 - Connected via network
- Analog cameras
 - Connected to encoders, BRS / DiBos devices
- Decoders
 - Connected via network
- Analog monitors
 - Connected to a decoder, to a Bosch Allegiant matrix, to a Bosch VMS Client workstation
- BRS / DiBos devices (see the data sheet for Bosch VMS for supported software versions)
 - Connected via network
- Bosch Allegiant matrix (Firmware version: 8.75 or greater, MCS version: 2.80 or greater)

Connected to a COM port of the Management Server or to a remote computer and to an IP encoder on the network.

5.3 Connecting a Bosch IntuiKey keyboard to Bosch VMS

This chapter provides background information on configuring a Bosch IntuiKey keyboard.

5.3.1 Scenarios for Bosch IntuiKey keyboard connections

You can connect a Bosch IntuiKey keyboard to the COM port of a Bosch VMS workstation (scenario 1) or to a hardware decoder (e.g. VIP XD, scenario 2).

If you connect the keyboard to a Bosch VMS workstation, you can control the complete system. If you connect the keyboard to a decoder, you can only control the analog monitors of the system.

If you connect the keyboard to an Enterprise Operator Client, you can control the cameras of a specific Management Server by first pressing the server key to type in the number of this server and then type the camera number.



Notice!

For connecting the Bosch IntuiKey keyboard with a Bosch VMS workstation, use the specified Bosch cable.

For connecting the Bosch IntuiKey keyboard with a VIP XD decoder, you need a cable which connects a serial COM port of the keyboard with the serial interface of the decoder. See Connecting a CCTV keyboard to a decoder for connections.

Bosch IntuiKey keyboard connected to a Bosch VMS workstation

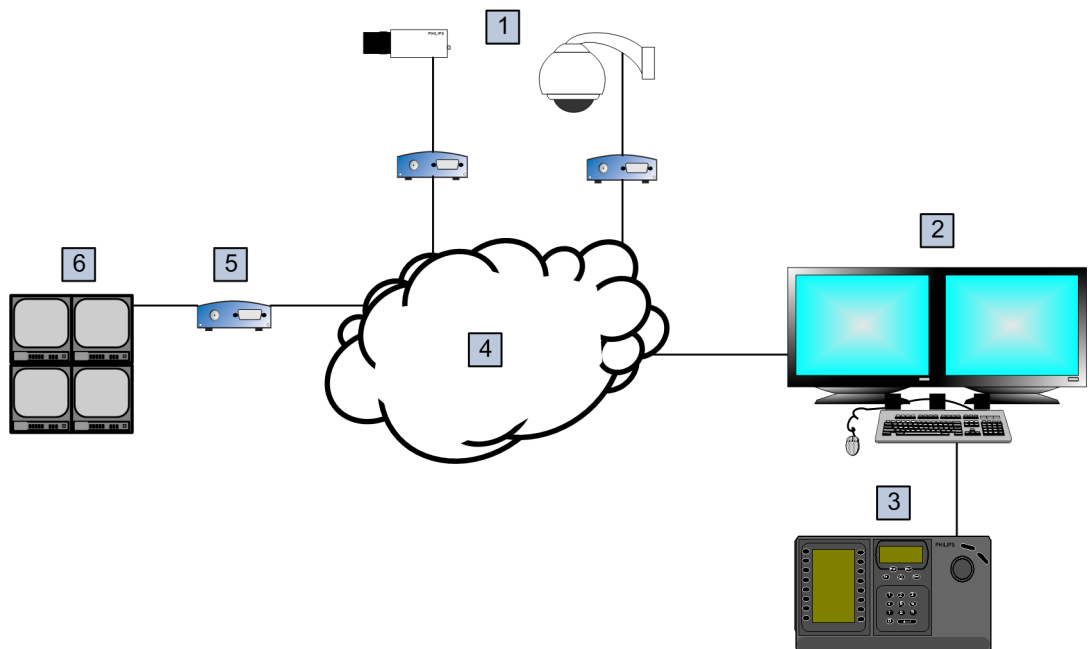

Figure 5.1: Scenario 1: Bosch IntuiKey keyboard connected to a Bosch Video Management System workstation

1	Various cameras connected to network via encoders
2	Bosch VMS workstation
3	Bosch IntuiKey keyboard
4	Bosch VMS network

5	Decoder
6	Analog monitors

Bosch IntuiKey keyboard connected to a decoder

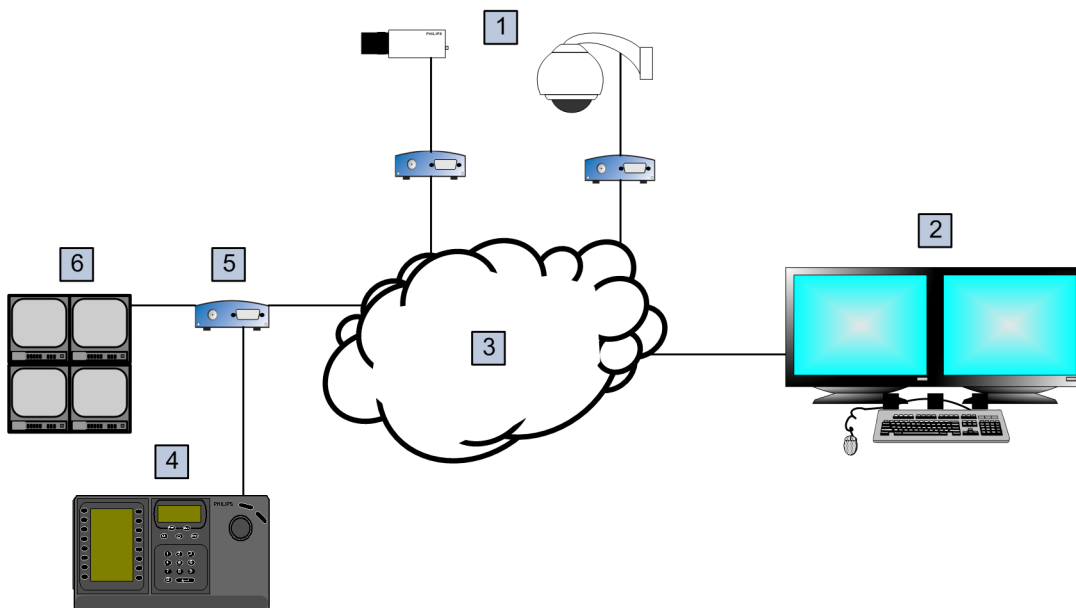

Figure 5.2: Scenario 2: Bosch IntuiKey keyboard connected to a decoder

1	Various cameras connected to network via encoders
2	Bosch VMS workstation
3	Bosch VMS network
4	Bosch IntuiKey keyboard
5	Decoder
6	Analog monitors

Follow these references to get detailed information on the available windows:

- *Assign Keyboard page, page 262*

Follow these references to get detailed information on the available step-by-step instructions:

- *Configuring a Bosch IntuiKey keyboard (workstation), page 165*
- *Configuring a Bosch IntuiKey keyboard (decoder), page 165*
- *Configuring a decoder for use with a Bosch IntuiKey keyboard, page 160*

See also

- *Assign Keyboard page, page 262*

5.3.2

Connecting a Bosch IntuiKey keyboard to a decoder

Configuring the decoder

See *Configuring a decoder for use with a Bosch IntuiKey keyboard, page 160* for details.

Connections between COM port and VIP XD decoder

The following table lists the connections between an RS232 adapter and a serial interface of a VIP XD decoder:

RS232 adapter	Serial interface of a VIP XD decoder
1	
2	TX
3	RX
4	
5	GND
6	
7	CTS
8	RTS
9	

The following illustration shows the pinout of a standard RS232 adapter (1) and the pinout of the decoder’s serial adapter (2):

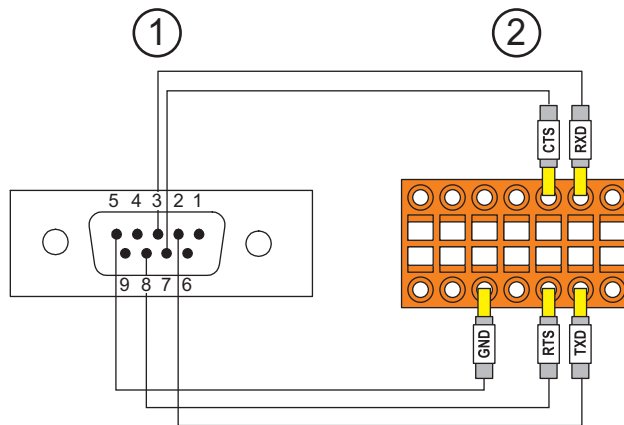

5.3.3

Updating Bosch IntuiKey keyboard firmware

1. On any PC, install the IntuiKey downloader.
2. Start IntuiKey Firmware Upgrade Utility.
3. Connect the keyboard with a valid serial cable (refer to Bosch Support if such a cable is not available) to this PC.
4. On the keyboard, press Keyboard Control softkey, then Firmware Upgrade.
5. Enter the password: 0 and 1 simultaneously.
The keyboard is in bootloader mode.
6. On the PC, click Browse to select the firmware file: for example kbd.s20
7. Set the COM port.
8. Click the Download button to download the firmware.
On the keyboard display, Programming is displayed.
Do not press the Clr key now. Otherwise the keyboard is not usable after restart (see Notice below).
9. Click Browse to select the language: for example 8900_EN_..82.s20
On the keyboard display, Programming is displayed.
10. Close IntuiKey Firmware Upgrade Utility.

11. On the keyboard, press Clr key to exit.
The keyboard restarts. Wait some seconds until the menu for selecting the keyboard language appears.
12. Select the desired language with a softkey.
The default start display appears.

**Notice!**

For starting the bootloader mode directly, you can unplug the power supply from the keyboard, press 0 and 1 simultaneously, plug in the power supply again, release 0 and 1.

5.4

Connecting Bosch Allegiant Matrix to Bosch Video Management System

The Bosch VMS Allegiant Matrix interface provides seamless access to analog matrix cameras in the Operator Client interface. Allegiant cameras appear almost identical to IP cameras. The only difference is a small grid symbol on the camera to indicate that it is a Allegiant camera. You can display cameras using the same tasks as for IP cameras. They are included both in the Logical Tree and the site maps, and users can add them to their Favorites Trees. In-video-window control for Allegiant-connected PTZ cameras is supported, and you can easily display Allegiant cameras on analog monitors connected to IP decoders.

Bosch VMS provides an interface to the matrix switch via the Allegiant MCS (Master Control Software) application). The MCS, in this case, runs invisibly in the background. This software provides an efficient, event-driven interface to the Allegiant. It provides fast, real-time event response from the Allegiant to Bosch VMS. So, for example, if a defective coax cable results in video loss in the Allegiant, an immediate notification is sent to Bosch VMS. Also, you can program Bosch VMS to respond to Allegiant alarms.

5.4.1

Bosch Allegiant Connection Overview

To achieve a connection between Bosch VMS and an Allegiant matrix switching system, you configure a control channel between the Bosch VMS and the Allegiant matrix.

Two scenarios are possible:

- Local connection
The Management Server controls the Allegiant matrix.
- Remote connection
A dedicated Bosch Allegiant PC connected to the network controls the Allegiant matrix.

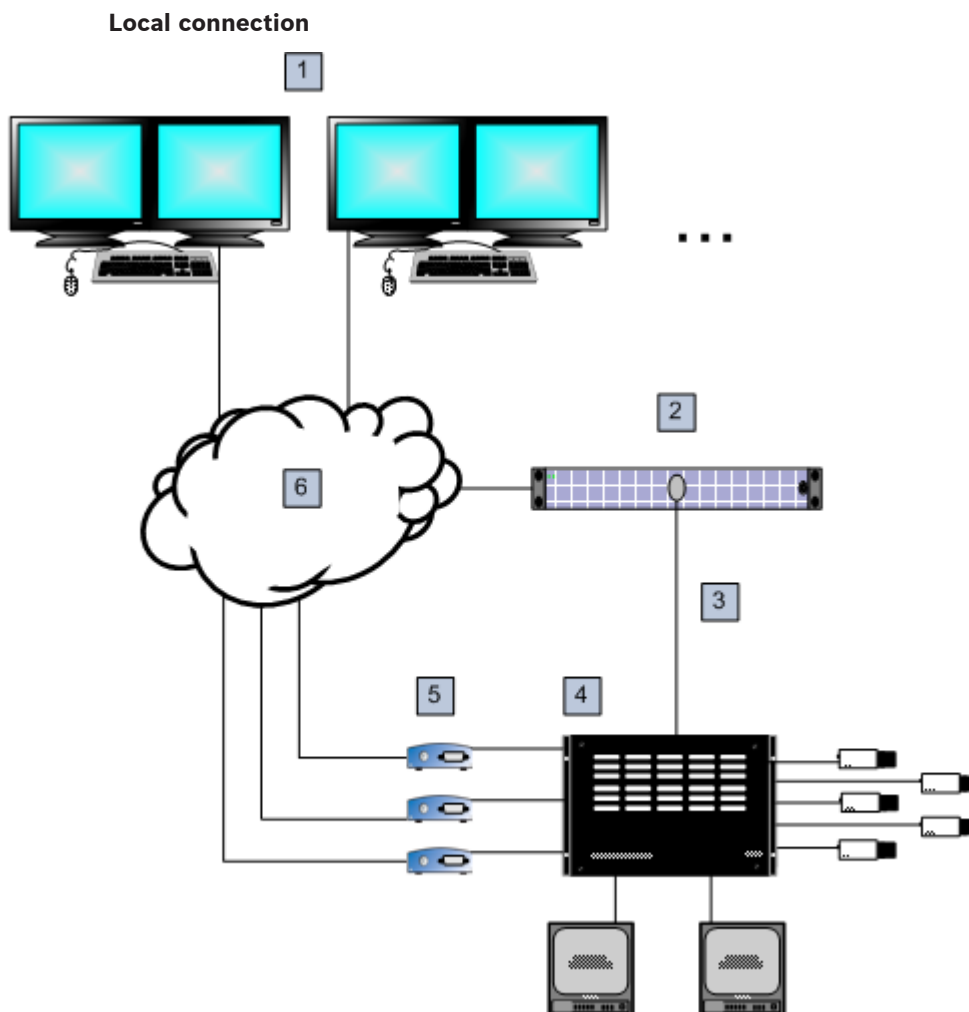

Figure 5.3: Bosch Video Management System local connection to a Bosch Allegiant matrix switch

1	Bosch VMS Client workstations
2	Management Server with Master Control Software
3	RS-232 connection
4	Allegiant matrix
5	encoders
6	Network

Remote connection

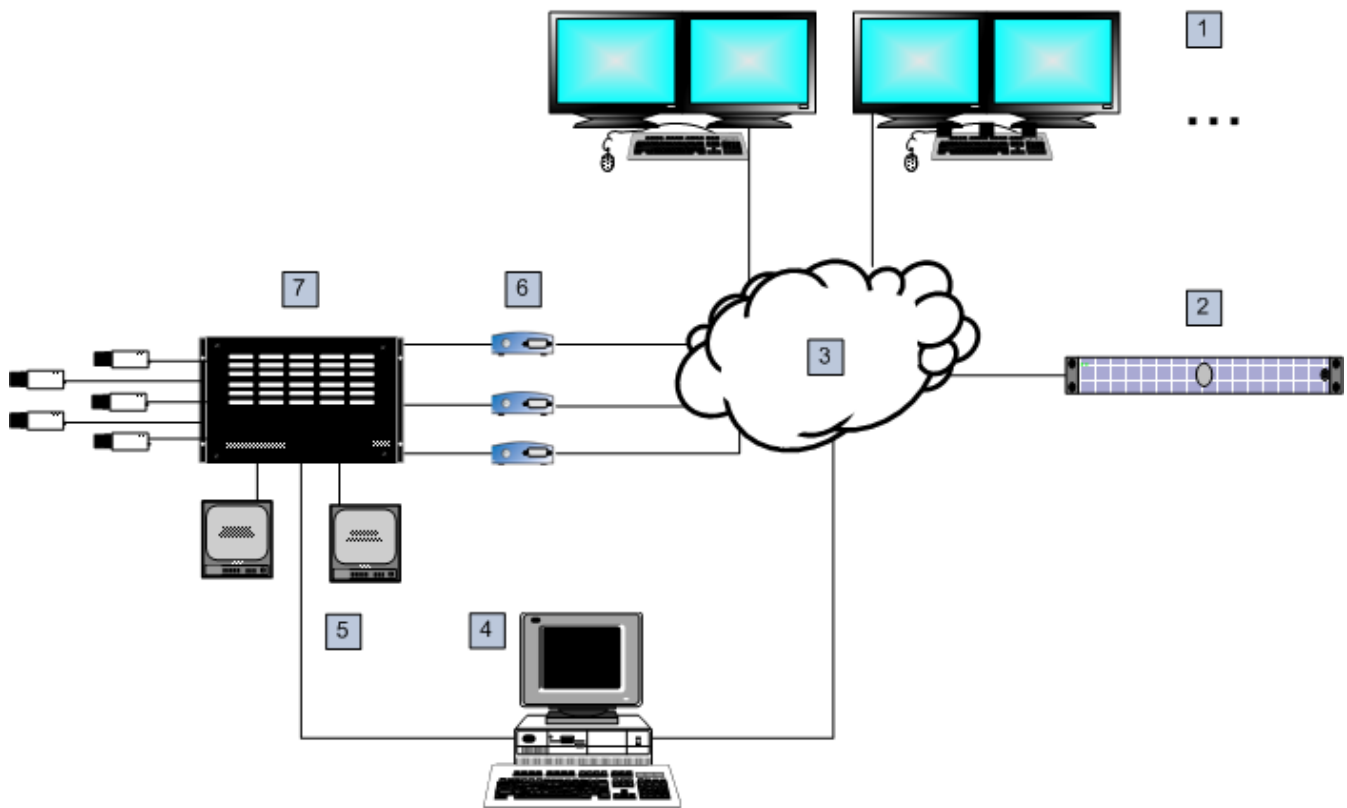

Figure 5.4: Bosch Video Management System remote connection to a Bosch Allegiant matrix switch

1	Bosch VMS Client workstations
2	Management Server with Master Control Software
3	Network
4	Allegiant PC with Master Control Software
5	RS-232 connection
6	encoders
7	Allegiant matrix

5.4.2 Configuring the control channel

Perform the following tasks to configure the control channel:

- Wiring
- Installing the software
- Creating Allegiant configuration file
- Adding the Allegiant matrix to Bosch VMS
- Configuring user names

Wiring

To configure the control channel between Bosch VMS and the Allegiant matrix, connect one PC through an RS-232 serial port to the Allegiant's console port (use the specified Bosch cable for connection). This can be the Bosch VMS Management Server, or any other PC on the network.

Installing Allegiant Master Control Software

1. Stop the Management Server service if running (**Start > Control Panel > Services > Right-click Bosch VMS Management Server > Stop**)
2. Install the Allegiant Master Control Software on the Management Server and on the Allegiant PC (if present).
3. On an remote Allegiant PC configure it to start the Allegiant Network Host program (Id_alghw.exe) on startup. This starts the necessary Allegiant services to allow other PCs on the network to access the Allegiant. The software runs invisibly. It is not necessary to have a dongle attached to this computer.
To have the service started on computer startup automatically, copy a link to Id_alghw.exe to the Startup folder of your computer.

Creating a Bosch Allegiant configuration file

1. Using the Allegiant Master Control Software, create a Allegiant configuration file that specifies the computer attached to the Allegiant matrix. For this task, the Master Control dongle is required.
2. On the Transfer menu, click Communication Setup. In the Current Host list, enter the DNS name of the computer connected to the Allegiant matrix, and enter the serial port parameters (COM port number, baud rate, etc.) of the Allegiant-connected serial port. This allows the Master Control Software on the Management Server or PC to go on-line with the Allegiant system. If this is not successful, ensure that either the Master Control Software or the Allegiant Network Host program is running on the computer attached to the Allegiant matrix, and that the network security is configured to allow remote access to this computer.
3. On the Transfer menu, click Upload. Select all tables and click Upload. To save the configuration file, select a directory.
4. Exit the Master Control Software.

Adding the Bosch Allegiant matrix to Bosch VMS

1. Start the Bosch VMS Management Server service, start the Configuration Client, and add the Allegiant device by adding this configuration file (see *Adding a device manually*, page 155 for the step-by-step instruction).
2. Ensure that the Allegiant Master Control Software configuration file used in Bosch VMS matches the current Allegiant configuration.
Bosch VMS runs the required components of Master Control Software invisibly in the background.

Configuring the user name for logging on the Allegiant services

If the Allegiant matrix is connected to a PC in the network and not to the Management Server, ensure that the Allegiant services on this PC and on the Management Server log on with the same user account. This user must be member of an administrators group.

Further notes in the documentation

Follow these references to get detailed information on the available windows:

- *Matrix Switches page, page 241*

Follow these references to get detailed information on the available step-by-step instructions:

- *Configuring a Bosch Allegiant device, page 162*

See also

- *Matrix Switches page, page 241*

5.4.3

Bosch Allegiant Satellite System Concept

The Allegiant matrix switch allows multiple Allegiant systems to be tied together using the Satellite concept. In this case, multiple Allegiant systems can appear to the Bosch VMS as one large system, providing access to all cameras on all systems.

In an Allegiant Satellite System, monitor outputs of a slave Allegiant are tied to video inputs on the master Allegiant. This connection is called a trunk line. In addition, a control channel is established between the master and the slave. When a camera from a slave Allegiant is requested from the master Allegiant, a command is sent to the slave instructing it to switch the requested camera to a trunk line. At the same time, the master Allegiant switches the trunk input to the requested master Allegiant monitor output. This completes the video connection from the requested slave camera to the desired master monitor.

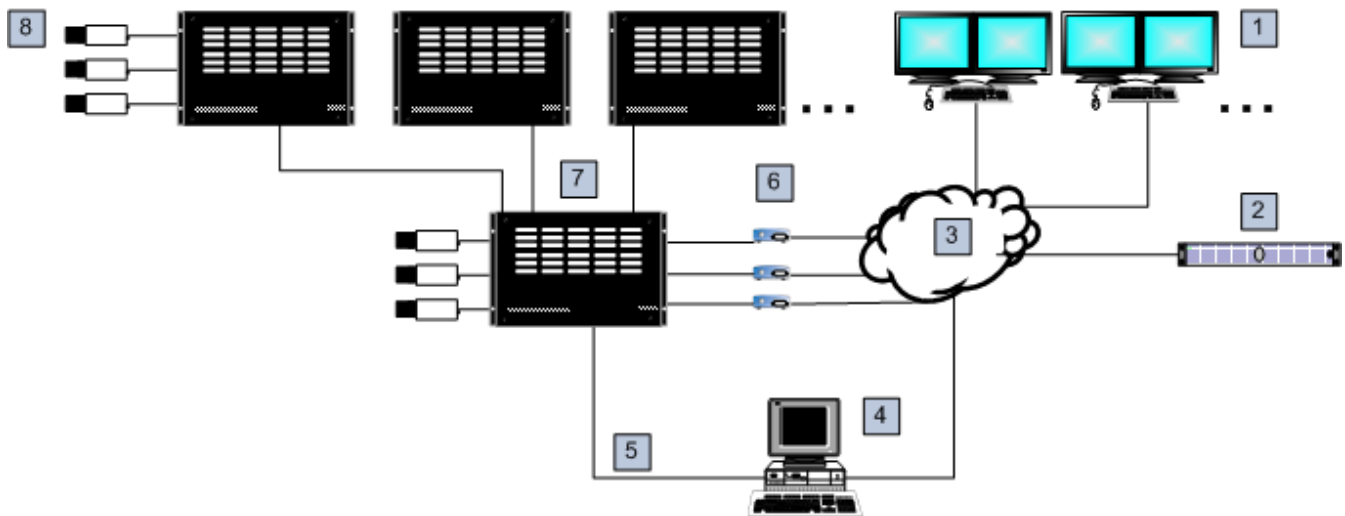

Figure 5.5: Bosch Allegiant system extended with Satellite switches

1	Bosch VMS Client workstations
2	Management Server with Master Control Software
3	Network
4	Allegiant PC with Master Control Software
5	RS-232 connection
6	encoders
7	Allegiant matrix
8	Allegiant Satellite matrix

You can apply the Satellite concept such that an Allegiant can be both a master and a slave. In this way, each Allegiant can view cameras from the others. It is only necessary to connect trunk lines and control lines in both directions, and to properly configure the Allegiant tables. The concept can be further extended, with no practical limit, to multiple Allegiant systems. An Allegiant can have many slaves, and it can be a slave to many masters. You can program the Allegiant tables to allow or disallow user access to camera views as required by site policies.

5.5

Allegiant CCL commands supported in Bosch VMS

To use the CCL commands you need the CCL User Guide. This manual is available in the Online Product Catalog in the document section of each LTC Allegiant Matrix.

Supported command	Description	Remarks
Switching/Sequence		
LCM	Switch Logical Camera to Monitor	LCM, LCM+ and LCM- are equivalent.
LCMP	Switch Logical Camera to Monitor with Pre-position Call	
MON+CAM	Switch Physical Camera to Monitor	
MON-RUN	Run Sequence by Monitor Number	
MON-HOLD	Hold Sequence by Monitor Number	
SEQ-REQ	Sequence Request	
SEQ-ULD	Sequence Unload	
Receiver/Driver		
R/D	Basic Control commands	
REMOTE-ACTION	Simultaneous Pan/Tilt/Zoom Control commands	
REMOTE-TGL	Toggle Pan/Tilt/Zoom Control commands	
PREPOS-SET	Set Pre-position	
PREPOS	Call Pre-position	
AUX-ON AUX-OFF	Auxiliary Control commands – Auxiliary On – Auxiliary Off	
VARSPEED_PTZ	Variable Speed Control commands	
Alarm		
+ALARM	Activate an alarm	Used to control virtual inputs. For example "+alarm 1" closes virtual input 1, "-alarm 1" opens virtual input 1
-ALARM	Deactivate an alarm	Opens a virtual input in Bosch VMS. Closes a virtual input in Bosch VMS.
System		
TC8x00>HEX	Set Hexadecimal Mode	

Supported command	Description	Remarks
Switching/Sequence		
TC8x00>DECIMAL	Set Decimal Mode	

6 Getting started

This chapter provides information on how to get started with Bosch VMS.

6.1 Installing the software modules

Caution!

Close Configuration Client before you start the Bosch VMS Setup.

Caution!

Do not install DiBos Web client on any Bosch VMS computer.

Install every software module on the computer that is supposed to be used for this module.

To install:

1. Insert the product CD-ROM.
2. Start Setup.exe or start the Bosch VMS Setup on the Welcome screen.
3. In the next dialog box, select the modules to be installed on this computer.
4. Follow the instructions on the screen.

6.2 Scanning for devices



Main window > **Devices**

You can scan for the following devices to add them with the help of the **Bosch VMS Scan Wizard** dialog box:

- VRM devices
- Encoders
- Live only encoders
- Live only ONVIF encoders
- Local storage encoders
- Decoders
- Video Streaming Gateway (VSG) devices
- DVR devices
- VIDOS NVRs

See also

- *To add VRM devices via scan., page 83*
- *To add encoders via scan., page 84*
- *To add Bosch live only devices via scan., page 84*
- *To add ONVIF live only devices via scan., page 85*
- *To add local storage encoders via scan., page 85*
- *To add VSG devices via scan., page 85*
- *To add DVR devices via scan., page 86*
- *To add VIDOS NVRs via scan., page 86*

To add VRM devices via scan:

1. Right-click  and click **Scan for VRM Devices**.
The **Bosch VMS Scan Wizard** dialog box is displayed.
2. Select the desired check boxes for the devices that you want to add.

3. In the **Role** list, select the desired role.
It depends on the current type of the VRM device which new role you can select.
If you select **Mirrored** or **Failover**, the next configuration step is additionally required.
4. Click **Next >>**.
The **Authenticate Devices** dialog box of the wizard is displayed.
5. Type in the password for each device that is protected by a password.
Password check is performed automatically, when you do not enter a further character in the password field for a few seconds or you click outside the password field.
If the passwords of all devices are identical, you can enter it in the first **Password** field.
Then right-click this field and click **Copy cell to column**.



In the **Status** column, the successful logons are indicated with



The failed logons are indicated with

6. Click **Finish**.
The device is added to your Bosch VMS.

To add encoders via scan:

1. Right-click  and click **Scan for Encoders**.
The **Bosch VMS Scan Wizard** dialog box is displayed.
2. Select the required encoders, select the desired VRM pool and click **Assign** to assign them to the VRM pool.
3. Click **Next >>**.
The **Authenticate Devices** dialog box of the wizard is displayed.
4. Type in the password for each device that is protected by a password.
Password check is performed automatically, when you do not enter a further character in the password field for a few seconds or you click outside the password field.
If the passwords of all devices are identical, you can enter it in the first **Password** field.
Then right-click this field and click **Copy cell to column**.



In the **Status** column, the successful logons are indicated with



The failed logons are indicated with

5. Click **Finish**.
The device is added to your Bosch VMS.

To add Bosch live only devices via scan:

1. Right-click  and click **Scan for Live Only Encoders**.
The **Bosch VMS Scan Wizard** dialog box is displayed.
2. Select the desired check boxes for the devices that you want to add.
3. Click **Next >>**.
The **Authenticate Devices** dialog box of the wizard is displayed.
4. Type in the password for each device that is protected by a password.
Password check is performed automatically, when you do not enter a further character in the password field for a few seconds or you click outside the password field.
If the passwords of all devices are identical, you can enter it in the first **Password** field.

Then right-click this field and click **Copy cell to column**.

In the **Status** column, the successful logons are indicated with .

The failed logons are indicated with .

5. Click **Finish**.

The device is added to your Bosch VMS.

To add ONVIF live only devices via scan:

1. Right-click  and click **Scan for Live Only ONVIF Encoders**.

The **Bosch VMS Scan Wizard** dialog box is displayed.

2. Select the desired check boxes for the devices that you want to add.
3. Click **Next >>**.

The **Authenticate Devices** dialog box of the wizard is displayed.

4. Type in the password for each device that is protected by a password.
Password check is performed automatically, when you do not enter a further character in the password field for a few seconds or you click outside the password field.

If the passwords of all devices are identical, you can enter it in the first **Password** field.

Then right-click this field and click **Copy cell to column**.

In the **Status** column, the successful logons are indicated with .

The failed logons are indicated with .

5. Click **Finish**.

The device is added to your Bosch VMS.

To add local storage encoders via scan:

1. Right-click  and click **Scan for Local Storage Encoders**.

The **Bosch VMS Scan Wizard** dialog box is displayed.

2. Select the desired check boxes for the devices that you want to add.
3. Click **Next >>**.

The **Authenticate Devices** dialog box of the wizard is displayed.

4. Type in the password for each device that is protected by a password.
Password check is performed automatically, when you do not enter a further character in the password field for a few seconds or you click outside the password field.

If the passwords of all devices are identical, you can enter it in the first **Password** field.

Then right-click this field and click **Copy cell to column**.

In the **Status** column, the successful logons are indicated with .

The failed logons are indicated with .

5. Click **Finish**.

The device is added to your Bosch VMS.

To add VSG devices via scan:

1. Right-click  and click **Scan for Video Streaming Gateways**.

The **Bosch VMS Scan Wizard** dialog box is displayed.

2. Select the required VSG devices, select the desired VRM pool and click **Assign** to assign them to the VRM pool.
3. Click **Next >>**.
The **Authenticate Devices** dialog box of the wizard is displayed.
4. Type in the password for each device that is protected by a password.
Password check is performed automatically, when you do not enter a further character in the password field for a few seconds or you click outside the password field.
If the passwords of all devices are identical, you can enter it in the first **Password** field.
Then right-click this field and click **Copy cell to column**.



In the **Status** column, the successful logons are indicated with .



The failed logons are indicated with .

5. Click **Finish**.
The device is added to your Bosch VMS.

To add DVR devices via scan:

1. Right-click  and click **Scan for DVR Devices**.
The **Bosch VMS Scan Wizard** dialog box is displayed.
2. Select the desired check boxes for the devices that you want to add.
3. Click **Next >>**.
The **Authenticate Devices** dialog box of the wizard is displayed.
4. Type in the password for each device that is protected by a password.
Password check is performed automatically, when you do not enter a further character in the password field for a few seconds or you click outside the password field.
If the passwords of all devices are identical, you can enter it in the first **Password** field.
Then right-click this field and click **Copy cell to column**.



In the **Status** column, the successful logons are indicated with .



The failed logons are indicated with .

5. Click **Finish**.
The device is added to your Bosch VMS.

To add VIDOS NVRs via scan:

1. Right-click  and click **Start Vidos NVR Scan**.
The **Bosch VMS Scan Wizard** dialog box is displayed.
2. Select the desired check boxes for the devices that you want to add.
3. Click **Next >>**.
The **Authenticate Devices** dialog box of the wizard is displayed.
4. Type in the password for each device that is protected by a password.
Password check is performed automatically, when you do not enter a further character in the password field for a few seconds or you click outside the password field.
If the passwords of all devices are identical, you can enter it in the first **Password** field.
Then right-click this field and click **Copy cell to column**.



In the **Status** column, the successful logons are indicated with .



The failed logons are indicated with .

5. Click **Finish**.
The device is added to your Bosch VMS.

See also

- *Adding a device manually, page 155*
- *Bosch VMS Scan Wizard, page 267*

6.3 Using Config Wizard

To start Config Wizard:

- ▶ Click **Start** > **All Programs** > **Bosch VMS** > Config Wizard
The Welcome page is displayed.

Related Topics

- *Config Wizard, page 26*

Available pages

- *Welcome page, page 88*
- *System page, page 89*
- *Basic page, page 90*
- *Scan page, page 91*
- *Authentication page, page 92*
- *Cameras page, page 93*
- *Recording page, page 94*
- *Storage page, page 95*
- *Users page, page 96*
- *Finish page, page 97*

Welcome page

1 Welcome **2** System **3** Basic **4** Scan **5** Authentication **6** Cameras **7** Recording **8** Storage **9** Users **10** Finish

Welcome

Config Wizard helps you set up your Bosch VMS quickly.

The following prerequisites must be fulfilled:

- The cameras and other network devices must have invariable IP addresses (either by using fixed IP addresses or by using static DHCP assignment).
- For cameras and other network devices to be added you must know whether they are connected to the local subnet or to other subnets.
- You need the IP addresses of storage devices that you want to add.

Config Wizard has been initialized successfully. License is valid. Further steps can be performed.

[Next](#)

Restrictions of Config Wizard

- Config Wizard is intended for configuring a VMS where Management Server and VRM run on the same computer.
- If licenses are missing, Config Wizard allows you to save the new configuration.
- Config Wizard can only detect the following device types in the network: video encoder, video decoder and DVR.
- Storage to be added must be ready for recording. This means the device must have at least one formatted LUN. Use Configuration Client for configuring storage devices and formatting their LUNs.
- Config Wizard does not support adding Bosch DSA E-Series storage devices to the configuration.

About Config Wizard

Bosch VMS - Config Wizard 6.0
Build 6.0.0.120

Copyright (c) 2006-2015 by Bosch Sicherheitssysteme GmbH. All rights reserved. Patents pending. Warning: Unauthorized reproduction or distribution of this program, or any portion of it, may result in severe civil and criminal penalties, and will be prosecuted to the maximum extent possible under the law. Portions of Bosch VMS use MS Windows Media Technologies (c) by Microsoft Corp.

[Open Source Licenses](#)

▶ Click **Next** button to continue.

System page

Network settings

Computer name: KLEINE-BOX

Network adapter: LAN-Verbindung

Auto settings (via DHCP)

IP address:

Subnet mask:

Default gateway:

DNS server:

Time settings

Time zone: (UTC+01:00) Amsterdam, Berlin, Bern, Rom, Stockh...

Automatically adjust clock for Daylight Saving Time

Date: Montag, 7. September 2015

Time: 14:49:45

Time server: time.windows.com

Next

Please assign a name to the computer and specify the network settings.

We recommend using the automatic settings for obtaining an IP address from a DHCP server if available. Make sure that the network devices get invariable IP addresses (Static DHCP).

In the field 'Time server' you can specify the IP address or URL of a NTP time server for automatic periodical synchronization of time. You can specify several time servers in the field, separated by blanks; this increases the accuracy of time and provides for fail safety if a time server should not be available. For best results specify local or regional time servers.



Notice!

Only available on DIVAR IP 3000 and DIVAR IP 7000.

You configure the network settings of the operating system.
You configure the time settings of the operating system.

Note:

We highly recommend defining a time server in a video surveillance environment.
As soon as you click **Next** button, the settings are activated.

Basic page

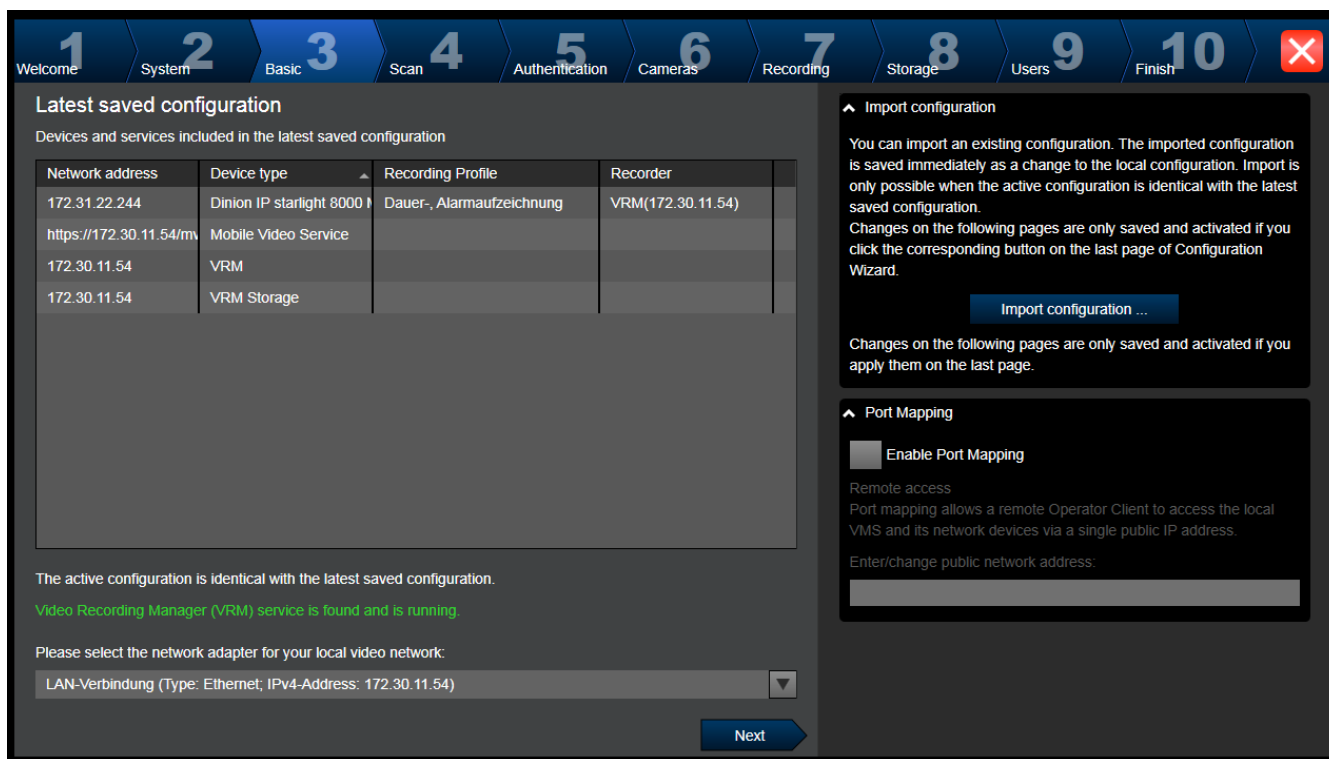

This page displays the latest saved configuration. You can import a Bosch VMS file as a change to the existing configuration. This change is saved but not activated when you click **Next**. You can select the network adapter of your computer that is connected to the video devices (IP cameras, encoders, decoders, iSCSI storage systems) of your system. The IP address of this network adapter is used as IP address of the VRM, the VSG and the local iSCSI storage system.

Click **Port Mapping** to specify the public IP address or DNS name if the system shall be accessed via Internet.

Scan page

Select video devices to be added

Selected 5 of 297

✓	Device name	IP address	MAC address	Device type
<input type="checkbox"/>	(172.31.22.235)	172.31.22.235	00-07-5f-72-0e-56	VIP X1600
<input type="checkbox"/>	VIP X16 XF E (CPP5)	172.31.22.232	00-07-5f-7e-90-af	VIP X16 XF E
<input type="checkbox"/>	VIP X1 XF IVA (172.31.22.231)	172.31.22.231	00-07-5f-75-a8-7f	VIP X1XF
<input checked="" type="checkbox"/>	DINION IP 7000 HD (172.31.22.230)	172.31.22.230	00-04-63-3f-0f-99	Dinion HD NBN-832VxP
<input type="checkbox"/>	NBC-255-P (172.31.22.229)	172.31.22.229	00-07-5f-74-99-2f	NBC-255-P
<input checked="" type="checkbox"/>	DINION IP bullet 5000 HD (172.31.22.228)	172.31.22.228	00-07-5f-7b-23-f9	IP bullet 5000 HD
<input type="checkbox"/>	FLEXIDOME NDN-921-P (172.31.22.226)	172.31.22.226	00-04-63-36-78-04	FlexiDome NDN-921-P
<input checked="" type="checkbox"/>	NDC-225-PI (172.31.22.225)	172.31.22.225	00-07-5f-74-b9-45	NDC-225-PI
<input type="checkbox"/>	VIP-X1600-XFM4 (172.31.22.224)	172.31.22.224	00-07-5f-74-ef-f1	VIP X1600 XFM4
<input type="checkbox"/>	VIP-X1600-XFM4 (172.31.22.223)	172.31.22.223	00-07-5f-75-40-6a	VIP X1600 XFM4
<input checked="" type="checkbox"/>	VIP-X1600-XFM4 (172.31.22.222)	172.31.22.222	00-07-5f-75-40-9a	VIP X1600 XFM4
<input type="checkbox"/>	(172.31.22.221)	172.31.22.221	00-07-5f-72-0e-71	VIP X1600
<input checked="" type="checkbox"/>	VIP-X1600-XFM4 (172.31.22.220)	172.31.22.220	00-07-5f-75-3d-29	VIP X1600 XFM4
<input type="checkbox"/>	FLEXIDOME IP corner 9000 M (172.31.22.216)	172.31.22.216	00-07-5f-7b-01-73	FlexiDome IP corner 9000 M
<input type="checkbox"/>	AUTODOME Jr 800 HD (172.31.22.215)	172.31.22.215	00-04-63-36-65-16	AutoDome Junior HD
<input type="checkbox"/>	FLEXIDOME IP panorami (172.31.22.214)	172.31.22.214	00-07-5f-88-76-44	FlexiDome panorama 5000 M

Scan options

Range of network scan:

- Local subnet only (recommended)
- Across subnets

Rescan network

Change network addresses

Change the IP addresses of the selected encoders/decoders. Start with the following IP address:

Change IP Addresses

Next

Note:

The scan for devices can take a time. You can cancel the scan. All devices that were already scanned, are displayed in the table.

This page displays all video devices that are not included in the latest saved configuration.

Deselect the devices that should not be added to the configuration, then click **Next**.

If the selected devices are not located in the same IP range as the DIVAR IP system, the device IP address can be changed by specifying a start address for the device IP range.

Authentication page

Enter authentication for devices

Device name	IP address	User name	Authentication	Status
NTC-255-PI (172.31.23.12)	172.31.23.12	service	<input type="password"/>	

You must authenticate at the devices of your system. To authenticate, enter the password for the user account of each device. An open green lock indicates a successful authentication.

You can only click 'Next' to continue, when all locks are green.

To copy a password for authentication select a row with a shown password and press Ctrl + C. Then select the rows of the devices for which the copied password should be used. To paste the password press Ctrl + V.

Change default password

You can specify a global default password. When you save the configuration, this password is set on all devices that are currently not protected. The password is set for the user accounts 'service', 'live', 'user', 'svadmin'.

Enforce password protection on activation
Required field

Global default password: Show password

Show passwords

Next

This page is used to authenticate at video devices protected by password. For easy authentication with the same password for multiple devices you can use the clipboard (CTRL +C, CTRL+V):

1. Click to activate **Show passwords**.
2. Select a row with a successfully authenticated device (green lock is displayed), press CTRL+C, select multiple rows displaying a red lock and press CTRL+V).

Password check is performed automatically, when you do not enter a further character in the password field for a few seconds or you click outside the password field.

You can provide a global default password for all devices that are currently not protected by a password.

Cameras page

The screenshot displays the 'Cameras' configuration page. At the top, a navigation bar shows steps 1 through 10: Welcome, System, Basic, Scan, Authentication, Cameras (highlighted), Recording, Storage, Users, and Finish. Below the navigation bar, the page is titled 'Specify camera settings'. It features a table with the following columns: Camera name, IP address, Recording quality, and Live quality. Two camera entries are listed, both with 'Bit Rate Optimized' recording quality and 'Balanced' live quality. To the right of the table, there are three paragraphs of instructional text: 'You can rename each camera in the 'Camera name' column.', 'You can configure recording quality and live quality for each camera. Fractional frame rates (FR) are indicated by the profile names and refer to the fraction of the maximum frame rate of the corresponding camera model.', and 'You can change the settings of the 'Recording quality' and the 'Live quality' columns of multiple cameras simultaneously. To that end select those cameras and change the settings in one of the selected cameras. If the settings in a column are not identical for all selected cameras, you can click '<no change>' to avoid changing these settings unintentionally.' Below the text, it says 'In the Preview pane, you can see a still image of the selected camera.' A 'Preview' section shows a video feed from 'Camera 1 (172.31.22.227)' with a timestamp of '19. Feb 2016 14:31:38'. At the bottom right of the configuration area is a 'Next' button.

Camera name	IP address	Recording quality	Live quality
Camera 1 (172.31.22.227)	172.31.22.227	Bit Rate Optimized	Balanced
Camera 1 (172.31.22.229)	172.31.22.229	Bit Rate Optimized	Balanced

Use this page to manage the cameras of your system.

Recording page

Specify recording settings

Selected 0 of 2

Device name	IP address	Recording profile	Storage Min Time (days)	Storage Max Time (days)
VIP X1 (172.31.22.227)	172.31.22.227	Continuous, Alarm Re	1	unlimited
NBC-255-P (172.31.22.229)	172.31.22.229	Continuous, Alarm Re	1	unlimited

Alarm Recording
 Alarm Recording Night and Weekend
 Continuous Only
 Continuous Only Night and Weekend
 Continuous, Alarm Recording
 No Recording

You can specify the recording profile and how long you want to store the recordings.

You can change the settings for several cameras in parallel. To that end select those cameras and change the settings in one of the selected cameras.
 If the settings in a column are not identical for all selected cameras, you can click '<no change>' to avoid changing these settings unintentionally.

Cameras recorded by DVR devices are not shown, because the recording settings for these cameras can only be set using the configuration application of the DVR device.

^ Motion Alarm Recording in Recording Profiles

Recording profile	Motion Triggered Alarm Recording
Alarm Recording	<input type="checkbox"/>
Alarm Recording Night and Weekend	<input type="checkbox"/>
Continuous Only	<input type="checkbox"/>
Continuous Only Night and Weekend	<input type="checkbox"/>
Continuous, Alarm Recording	<input checked="" type="checkbox"/>
No Recording	<input type="checkbox"/>

Next

Only those cameras are displayed on this page which were newly added. As soon as you activate this configuration, you cannot change the profile assignment of these cameras. You can enable motion recording for the recording profiles with both recording and alarm recording enabled. If required, configure recording and alarm recording in Configuration Client (**Scheduled Recording Settings** dialog box). VCA is activated automatically for each newly added camera.

Storage page

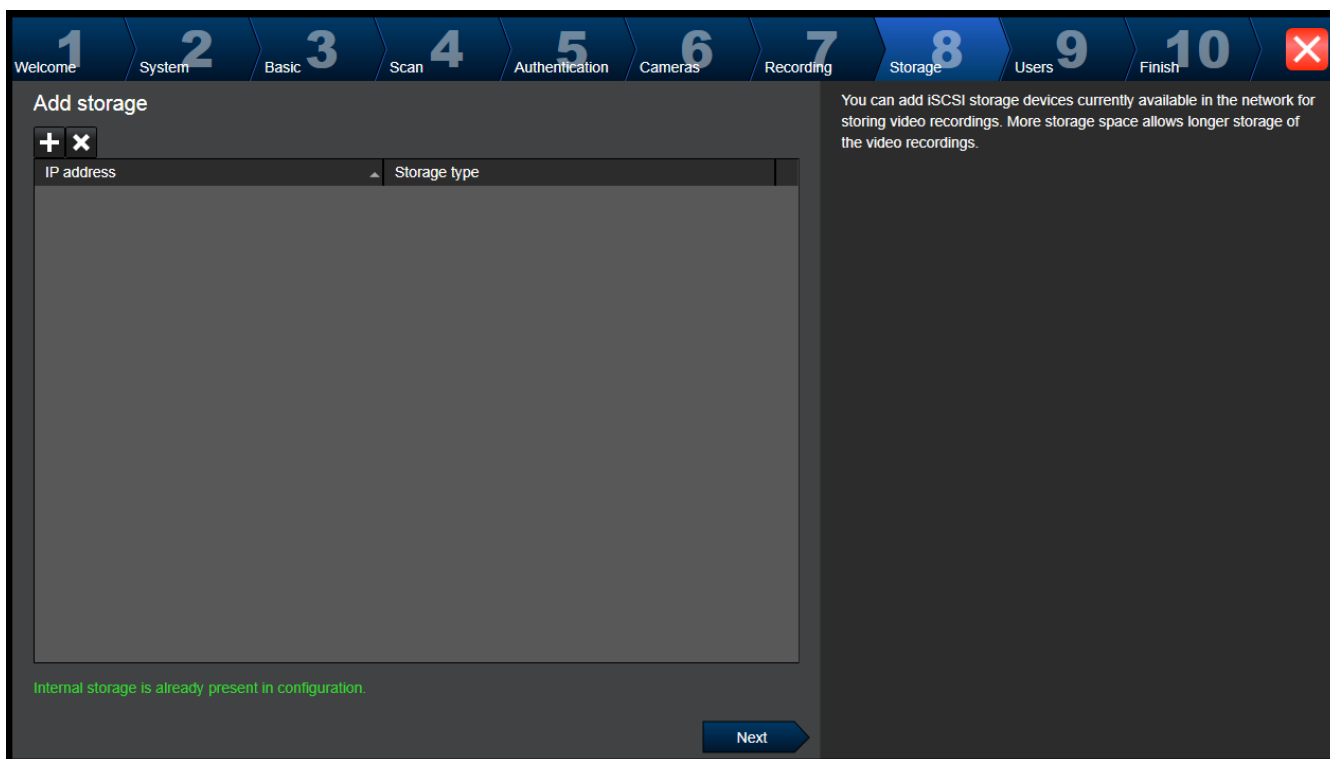

This page allows the addition of further iSCSI storage devices

Users page

User accounts and passwords

User Groups

- User Groups
 - Admin Group
 - Admin
 - Operator Group

User Properties

Full name:

Description:

Password

Strong password policy

Enter new password:

Confirm password:

Show password

You have successfully changed your password.

You can specify the names and passwords of users in predefined groups, and you can add further users to the predefined groups.

Different user groups have different permissions. These permissions define the operations allowed for users in this user group. You can add user groups and change permissions using Configuration Client.

For each user, you can enable a strong password policy. The following rules apply:

- Minimum 8 characters
- At least one upper-case letter (A through Z)
- At least one number (0 through 9)
- At least one special character (for example: ! \$ # %)
- Previous password must not be used.

You can add users and passwords and you can activate the strong password policy for each user. Use Configuration Client to add user groups and to change permissions.

Finish page

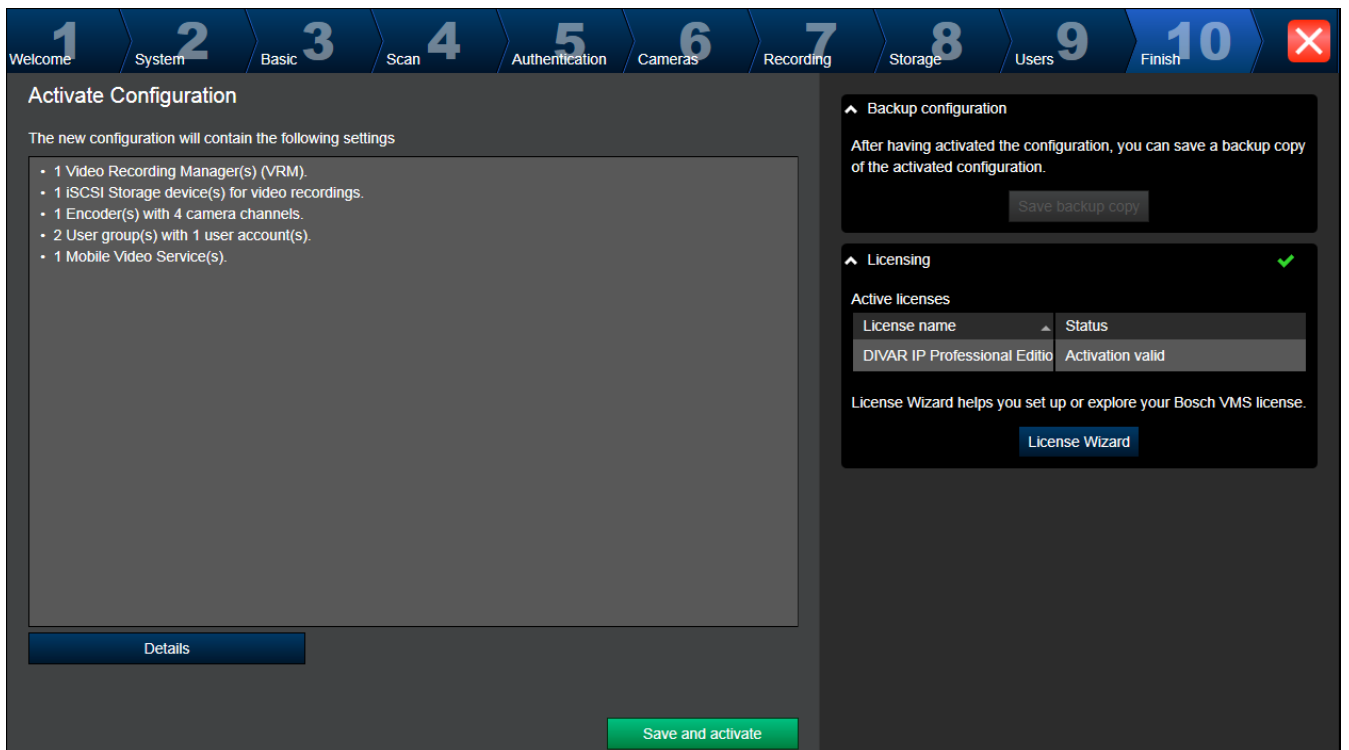

Before you can activate your configuration you must perform the following tasks:

- Provide a global default password for all devices that are not currently protected by a password.
- Activate your license package if required.

Global default password

If in Configuration Client the option **Enforce password protection on activation (Settings -> Options)** is disabled, you are not forced to provide a global default password to activate.

Licensing

Expand **Licensing** and click **License Wizard** to check or activate your license package.

After clicking **Save and activate**, the configuration is activated.

After successful activation, the **Finish** page is displayed again. Now you can store a backup of the configuration if desired: Click **Save backup copy**.

After clicking **Save and activate**, the configuration is activated.

After successful activation, the **Finish** page is displayed again. Now you can store a backup of the configuration if desired: Click **Save backup copy**.

6.4 Accessing the system

You access a system performing the following steps:

1. Perform one of the following steps to select the network address of the desired system:
 - Click a preselected list entry.
 - Enter a network address manually .
 - Select a network address using Server Lookup.
2. Log on to the desired system:
 - Single server system
 - Enterprise System

6.5 Using Server Lookup

A single user of Configuration Client or Operator Client may want to connect to multiple system access points sequentially. This access is called Server Lookup. System access points can be Management Server or Enterprise Management Server.

Server Lookup supports you in locating system access points by their names or descriptions. The user retrieves the list of system access points during logon. He needs to connect to the server hosting the configuration with **Server List / Address Book**.

To access:

1. Start Operator Client or Configuration Client.
The logon dialog box is displayed.
2. In the **Connection:** list, select **<Address Book...>** for Configuration Client or **<Address Book...>** for Operator Client.
If private and public IP address has been configured for a server, this is indicated.
If you select **<Address Book...>** or **<Address Book...>** for the first time, the **Server Lookup** dialog box is displayed.
3. In the **(Enterprise) Management Server Address:** field, type in a valid network address of the desired server.
4. Enter a valid user name and password.
5. If required, click **Remember Settings**.
6. Click **OK**.
The **Server Lookup** dialog box is displayed.
7. Select the desired server.
8. Click **OK**.
9. If the selected server has both a private and a public network address, a message box is displayed asking whether you are using a computer located in the private network of the selected server.
The server name is added to the **Connection:** list in the logon dialog box.
10. Select this server in the **Connection:** list and click **OK**.
If you have selected the **Remember Settings** check box, you can select this server directly when you again want to access this server.

6.6 Configuring remote access

You can configure remote access either for a single system without Enterprise System or for an Enterprise System.

6.6.1 Configuring without Enterprise System

To configure:

1. Configure remote access settings in the **Remote Access Settings** dialog box.
2. Configure the router.

Related Topics

- *Remote Access Settings dialog box, page 230*

6.6.2 Configuring with Enterprise System

To configure:

1. Configure the Server List.
2. Configure Enterprise User Groups and Enterprise Accounts.
3. Configure remote access settings in the **Remote Access Settings** dialog box.
4. Configure the router.

Related Topics

- *Configuring the Server List for Enterprise System, page 109*
- *Creating a group or account, page 209*
- *Remote Access Settings dialog box, page 230*

6.7 Activating the software licenses

Main window

When you install Bosch VMS for the first time, you must activate the licenses for the software packages that you have ordered, including the base package and any expansions and/or optional features.

To obtain the Activation Key for a license, you need the Authorization Number. This number is included in your product box.

With a Bundle Information file you can ease the process of activating.

Caution!

The computer signature is used for licensing. This computer signature can change after exchanging hardware on the Management Server computer. When the computer signature is changed, the license for the base package becomes invalid.

To avoid licensing problems, finish the hardware and software configuration before you generate the computer signature.

The following hardware changes can make the base license invalid:

Exchanging the network interface card.

Adding a VMWare or VPN virtual network interface.

Adding or activating a WLAN network interface.

Switchover of a Stratus server mainboard without teaming settings.

To activate the software:

1. Start Configuration Client.
2. On the **Tools** menu, click **License Manager....**
The **License Manager** dialog box is displayed.
3. Click to check the boxes for the software package, the features, and the expansions that you want to activate. For the expansions, enter the number of licenses.
If you have received a Bundle Information file, click **Import Bundle Info** to import it.
4. Click **Activate**.
The **License Activation** dialog box is displayed.
5. Write down the computer signature or copy and paste it into a text file.
6. On a computer with Internet access, enter the following URL into your browser:
<https://activation.boschsecurity.com>
If you do not have an account to access the Bosch License Activation Center, either create a new account (recommended) or click the link to activate a new license without logging on. If you create an account and log on before activating, the License Manager keeps track of your activations. You can then review this at any time.
Follow the instructions to obtain the License Activation Key.
7. Return to the Bosch VMS software. In the **License Activation** dialog box, type the License Activation Key obtained from the License Manager and click **Activate**.
The software package is activated.

See also

- *License Manager dialog box, page 227*
- *License Activation dialog box, page 228*

6.8 Starting Configuration Client

Only the user called Admin can log on to Configuration Client.

Note:

You cannot start Configuration Client when another user on another computer in the system has already started Configuration Client.

To start Configuration Client:

1. From the **Start** menu, select **Programs** > Bosch VMS > Config Client.
The dialog box for logging on is displayed.
2. In the **User Name:** field, type your user name.
When you start the application for the first time, enter Admin as user name, no password required.
3. In the **Password:** field, type your password.
4. Click **OK**.
The application starts.

6.9 Configuring the language of Configuration Client

You configure the language of your Configuration Client independently of the language of your Windows installation.



To configure the language:

1. On the **Settings** menu, click **Options....**
The **Options** dialog box is displayed.
2. In the **Language** list, select the desired language.
If you select **System language**, the language of your Windows installation is used.
3. Click **OK**.
The language is switched after the next restart of the application.

6.10 Configuring the language of Operator Client

You configure the language of your Operator Client independently of the language of your Windows installation and of your Configuration Client. This step is performed in the Configuration Client.

To configure the language:

1. Click **User Groups** > . Click the **User Group Properties** tab.
2. In the **Language** list, select the desired language.
3. Click  to save the settings.
4. Click  to activate the configuration.
Restart Operator Client.

6.11 Adding a new license

Main window

Have the Activation Letter at hand that you received from Bosch.

To add a new license:

1. On the **Tools** menu, click **License Manager....**
The **License Manager** dialog box is displayed.
2. Select the software package that you want to activate.

3. Click **Activate**.
The **License Activation** dialog box is displayed.
4. Type the License Activation Key that you find in the Activation Letter.
5. Click **Activate**.
The software package is activated.
6. Repeat this procedure for each software package that you want to activate.

Related Topics

- *License Manager dialog box, page 227*
- *License Activation dialog box, page 228*

6.12

Maintaining Bosch VMS

This chapter provides information on how to maintain a just installed or upgraded Bosch VMS. Perform the following tasks for maintaining the system:

- Export Bosch VMS configuration and user settings. The version history (all versions of the configuration that were activated earlier) is not exported. It is recommended to activate your configuration before exporting.
 - See *To export configuration data:, page 101* for the procedure.

Or

- Perform a backup of the elements.bvms. This is required if you want to restore an (Enterprise) Management Server including the version history. User settings are not included.
 - See *To perform a backup:, page 101* for the procedure.
- Save VRM configuration file (config.xml)
 - See *To save VRM configuration:, page 102* for the procedure.

This exported configuration does not keep the system's history. No rollback is possible.

The entire system configuration including the complete history of system changes is stored in one file:

C:\ProgramData\Bosch\VMS\Elements.bvms.

To export configuration data:

1. On the **System** menu, click **Export Configuration....**
The **Export Configuration File** dialog box is displayed.

Note: If your current working copy configuration is not activated ( is active), you export this working copy and not the activated configuration.

2. Click **Save**.
3. Enter a filename.
The current configuration is exported. A .zip file with database and user data is created.

To perform a backup:

1. Stop the service **Bosch VMS Central Server** on the (Enterprise) Management Server.
 2. Copy the file elements.bvms to the desired directory for backup.
 3. Start the service **Bosch VMS Central Server** on the (Enterprise) Management Server.
- The VRM configuration is stored in a single encrypted file config.xml.
The file can be copied and stored for backup while the VRM service is up and running.
The file is encrypted and contains all VRM relevant data such as:
- User data
 - All system devices and their VRM relevant settings

Parts of the VRM configuration are also stored in the Bosch VMS configuration. When you change something within these data, it is written to config.xml after activating the Bosch VMS configuration.

The following settings are not stored in the Bosch VMS configuration:

- **VRM Settings > Main Settings**
- **Network > SNMP**
- **Service > Advanced**
- **Recording preferences**
- **Load Balancing**

When you change something on one of these pages, it is written immediately to the VRM Server and not saved in the Bosch VMS configuration.

To save VRM configuration:

- ▶ Copy Config.xml to safe location.
You can find this file in the following directory for a Primary VRM:
C:\Program Files (x86)\Bosch\Video Recording Manager\primary\VRM Server
- You can find this file in the following directory for a Secondary VRM:
C:\Program Files (x86)\Bosch\Video Recording Manager\secondary\VRM Server

6.13 Replacing a device

This chapter provides information on how to repair the system for example when devices fail and must be replaced.

Prerequisite

The maintenance tasks have been performed.

See also

- *Maintaining Bosch VMS, page 101*

6.13.1 Replacing a MS / EMS

There is no difference between Management Server and Enterprise Management Server replacement.

You can either restore the configuration of the old Management Server or Enterprise Management Server or you can import the exported configuration.

When you restore the configuration, the Server ID remains unchanged.

When you import the configuration, the Server ID of the new system is used. You need a new Server ID if you want to create an Enterprise System using an exported configuration that you import in each Management Server as a template. Each Management Server in this Enterprise System must have a unique Server ID.

You can import an exported configuration and the user settings of this configuration. The user settings contain the users that were added in this configuration and their settings in Operator Client like window sizes and favorites.

Note: Importing a configuration does not restore the version history of the old configuration. When you import a configuration, no user settings are imported. You must manually restore the exported user settings.

To import the configuration:

1. On the **System** menu, click **Import Configuration...**
The **Import Configuration File** dialog box is displayed.
2. Select the desired file for import and click **Open**.
The **Import Configuration...** dialog box is displayed.

3. Enter the appropriate password and click **OK**.
 The Configuration Client is restarted. You must logon again.
 The imported configuration is not activated but editable in Configuration Client.

To restore the exported configuration:

You can only access (copy, delete) this file when the **Bosch VMS Central Server** service is stopped.

1. Stop the service **Bosch VMS Central Server** on the (Enterprise) Management Server.
2. If required, rename the backup file to Elements.bvms.
3. Replace the existing Elements.bvms.
4. Start the service **Bosch VMS Central Server** on the (Enterprise) Management Server.

Note: To reset the system to an empty configuration, stop the service and delete the Elements.bvms.

Further configuration files:

- Elements.bvms.bak (from V.2.2 on): Automatic backup file of the last activation including version history. Later changes of the configuration being not activated, are not included.
- Elements_Backup*****.bvms: Configuration from an older version. This file is created after a software update.

To restore the exported user settings:

1. Extract the zip file that was created during the maintenance export.
 The export.bvms file and the UserData directory are extracted.
2. On the desired (Enterprise) Management Server: Copy the UserData directory to C:\ProgramData\Bosch\VMS\.

















6.13.2

Replacing a VRM

To replace the VRM device from within Bosch VMS:

Prerequisite is an installed OS with correct network settings and the correct version of VRM (for example from the suitable Bosch VMS Setup DVD).

1. Start Bosch VMS Configuration Client.
2. In the Device Tree, select the VRM device.
3. Perform the settings on the following pages, then save and activate the configuration:

- Main window > **Devices** > Expand  > Expand  > 
- Main window > **Devices** > Expand  > Expand  > **VRM Settings** > **Main Settings**
- Main window > **Devices** > Expand  > Expand  > **Network** > **SNMP**
- Main window > **Devices** > Expand  > Expand  > **Service** > **Advanced**
- Main window > **Devices** > Expand  > Expand  >  >  > **Advanced Settings** > **Recording Preferences**
- Main window > **Devices** > Expand  > Expand  >  >  > **Load Balancing**

To replace the VRM device without Bosch VMS:

Prerequisite is an installed OS with correct network settings and the correct version of VRM (e.g. from the suitable Bosch VMS SetupDVD).

You use the original backup config.xml from the VRM device, containing all configuration settings (no further settings are required).

1. Stop the **Video Recording Manager** service.

2. Copy config.xml to the new server.
3. Start the **Video Recording Manager** service.

To replace an iSCSI device (planned failover):

1. Add the new iSCSI device.
2. Using Configuration Manager, on the iSCSI device to be replaced, configure all LUNs as read-only.

Note: You can remove the old iSCSI device when the old recordings are no longer required.

6.13.3 Replacing an encoder or decoder

Caution!

Do not remove a device from the Device Tree if you want to retain its recordings. For replacing this device, exchange the hardware.

Replacing an encoder/decoder of the same type

Prerequisite is a factory default device (IP Address = 192.168.0.1).

1. Disconnect the old device from the network.
2. Do not delete the device from the Device Tree in the Bosch VMS Configuration Client! When deleting the device from VRM, recording is lost.
3. Connect the new device of the same type to the network.

Caution!

The next steps require the above mentioned default IP address. With DHCP assigned IP addresses you cannot perform the initial device scan.

4. Configuration Client: On the **Hardware** menu, click **Initial Device Scan...**
The **Initial Device Scan** dialog box is displayed.
5. Click a cell to change the desired address. For changing multiple devices, select the desired rows. You can select multiple devices by pressing the CTRL- or the SHIFT-key. Then right-click the selected rows and click **Set IP Addresses...** or click **Set Subnet Mask...** to change the corresponding values.
You must enter the correct subnet mask and IP address.
Subnet mask and IP Address must be identical to the replaced device.
6. Click **OK**.
7. After a few seconds you can access the device setting in the Device Tree.
8. Change all required device settings that are not controlled by Bosch VMS (refer to information below).
9. Save and activate.

Notes:

- The initial device scan only finds devices with default IP addresses (192.168.0.1) or duplicate IP addresses.
- Do not use the VRM or NVR scan to scan defaulted devices since you will not be able to change the IP address afterwards.

Replacing an encoder with DHCP assigned IP address:

Prerequisite is a factory default encoder (DHCP assigned IP).

1. Connect the encoder to the Ethernet port of your computer directly.
2. Write down the network adapter configuration for TCP/IPv4 to restore it later.

3. On the network adapter of your computer, configure the following fixed IP address and subnet mask for your network adapter:
192.168.0.2
255.255.255.0
4. Start Internet Explorer.
5. In the **Address** bar, type in 192.168.0.1.
The Web page of the device is displayed.
6. Click **Settings**, then click **Network**.
7. On the **Network** page, in the **DHCP** list, select **Off**.
8. In the **IP address** field, in the **Subnet mask** field and in the **Gateway address** field, type in the required values valid for your network.
9. Click **Set and Reboot**.
10. Restore the network adapter configuration.



Replacing an encoder/decoder of another device type



- Disconnect the old device from the network.
- Do not delete the device from the Device Tree in the Bosch VMS Configuration Client!
When deleting the device from an NVR, recording is lost.
- Connect the new device of the new type to the network.

Main window >  **Devices** > Expand  > Expand  > Right-click  > Click **Edit Encoder** > **Edit Encoder** dialog box
or

Main window >  **Devices** > Right-click  > Click **Edit Encoder** > **Edit Encoder** dialog box
or

Main window >  **Devices** > Right-click  > Click **Edit Encoder** > **Edit Encoder** dialog box
or

Main window >  **Devices** > Expand  > Expand  > Right-click  > Click **Edit Encoder** > **Edit Encoder** dialog box
or

Main window >  **Devices** > Expand  > Right-click  > Click **Edit Decoder** > **Edit Decoder** dialog box

After an upgrade of the device, you can update its device capabilities. A message text informs you whether the retrieved device capabilities match the device capabilities stored in Bosch VMS.

To update:

1. Click **OK**.

A message box is displayed with the following text:

If you apply the device capabilities, the recording settings and the event settings for this device may change. Check these settings for this device.

2. Click **OK**.

The device capabilities are updated.

Replacing a VSG camera

When you replace a VSG camera, ensure that the replaced camera has the same type, the same IP address and the same ONVIV profile as the old camera.

Additionally you must perform the following settings on a new AXIS camera via the Web interface of the VSG camera before replacing the old AXIS camera:

- Set a password for user root
- Configure time synchronization
- Disable link-local address
- Create an ONVIF user
- Disable replay attack protection

Settings controlled by Bosch VMS

Encoders and decoders configured in a Bosch VMS system are controlled by the Bosch VMS Server and thus cannot be shared with other applications.

You can use the Bosch VMS Device Monitor to check which device show a mismatching configuration deviating from the Bosch VMS configuration.

Bosch VMS Configuration Client offers configuration pages for all BVIP devices.

The scale of settings depends on the particular BVIP model (e. g. VIPX 1600 XFM4).

Bosch VMS keeps control of all BVIP settings required for a seamless integration into a Bosch VMS system.

Settings controlled by Bosch VMS:

- Camera name
- Time server settings
- Recording Management (profiles, retention times, schedules)
- Definitions of quality settings
- Passwords

Stored in the Bosch VMS configuration but not changed on the devices:

- IP address (you can change IP addresses with Bosch VMS IP Device Configuration)
- Relay / input names (difference between names in the device and names configured in Bosch VMS is displayed)

System events for mismatching device configuration

- SystemInfo events are generated, once the configuration of a device has been fixed during a periodic check.
- SystemWarning events are generated, once a mismatching configuration has been detected on a device for the first time. Subsequent checks do not raise this event until the configuration has been corrected by an activation or a periodic fix.
- SytemError events are generated, once an error regarding configuration has been detected during activation or periodic checks. Subsequent checks do not raise this event until the configuration has been corrected by an activation or a periodic fix.

6.13.4 Replacing an Operator Client

To replace an Operator Client workstation:

1. Replace the computer.
2. Start the Bosch VMS Setup on the new computer.
3. In the list of components to be installed, select Operator Client.
If required, select other components that were installed on the replaced computer.
4. Install the software.

6.13.5 Final tests

To check MS / EMS replacement and Operator Client replacement:

1. Activate the configuration.
2. Start Operator Client.
3. Check the Logical Tree in Operator Client.
It must be identical with Logical Tree in Configuration Client.

To check VRM replacement:

- ▶ Start VRM Monitor and check the active recordings.

6.13.6 Recovering Divar IP 3000/7000

Refer to the Installation Manuals of DIVAR IP 3000 or DIVAR IP 7000. In the chapter on recovering the unit you find how to proceed.

6.14 Configuring time synchronization



Notice!

Ensure that the time of the all computers of Bosch VMS is synchronized with Management Server. Otherwise you can loose recordings.

Configure the time server software on Management Server. On the other computers, configure the IP address of Management Server as time server using standard Windows procedures.

6.15 Configuring the storage media of an encoder



Main window >  **Devices** > Expand  > Expand  >  >  > **Advanced Settings** > **Recording Management**

Note: Ensure that the desired cameras of this encoder are added to the Logical Tree. You must configure the storage media of an encoder to use the ANR function.

Note: If you want to configure the storage media of an encoder that has already been added to your system and is recorded via VRM, ensure that secondary recording is stopped:

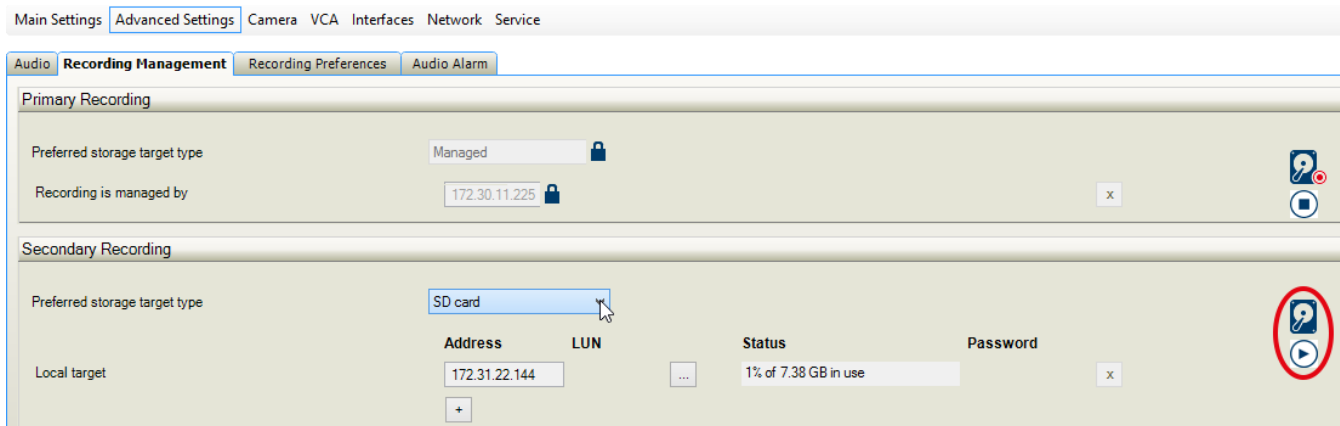

The ANR function only works on encoders with firmware version 5.90 or later. Not all encoder types support ANR even if the correct firmware version is installed.

To configure the storage media of an encoder:

1. Under **Secondary Recording**, in the **Preferred storage target type** list, select the storage media. Depending on the device type, different media are available.
2. If required, click the ... button to format the storage media.
After the successful formatting process, the storage media is ready for use with the ANR function.
3. Configure the ANR function for this encoder on the **Cameras and Recording** page.

See also

- *Recording Management page, page 294*
- *Configuring the ANR function, page 194*

6.16 Creating an Enterprise System

Perform the following tasks to create an Enterprise System on an Enterprise Management Server and on multiple Management Server computers:

1. *Configuring the Server List for Enterprise System, page 109*
2. *Creating an Enterprise User Group , page 110*
3. *Creating an Enterprise Account , page 111*

This example covers the Scenario 1 described in the *Enterprise System , page 26* chapter:

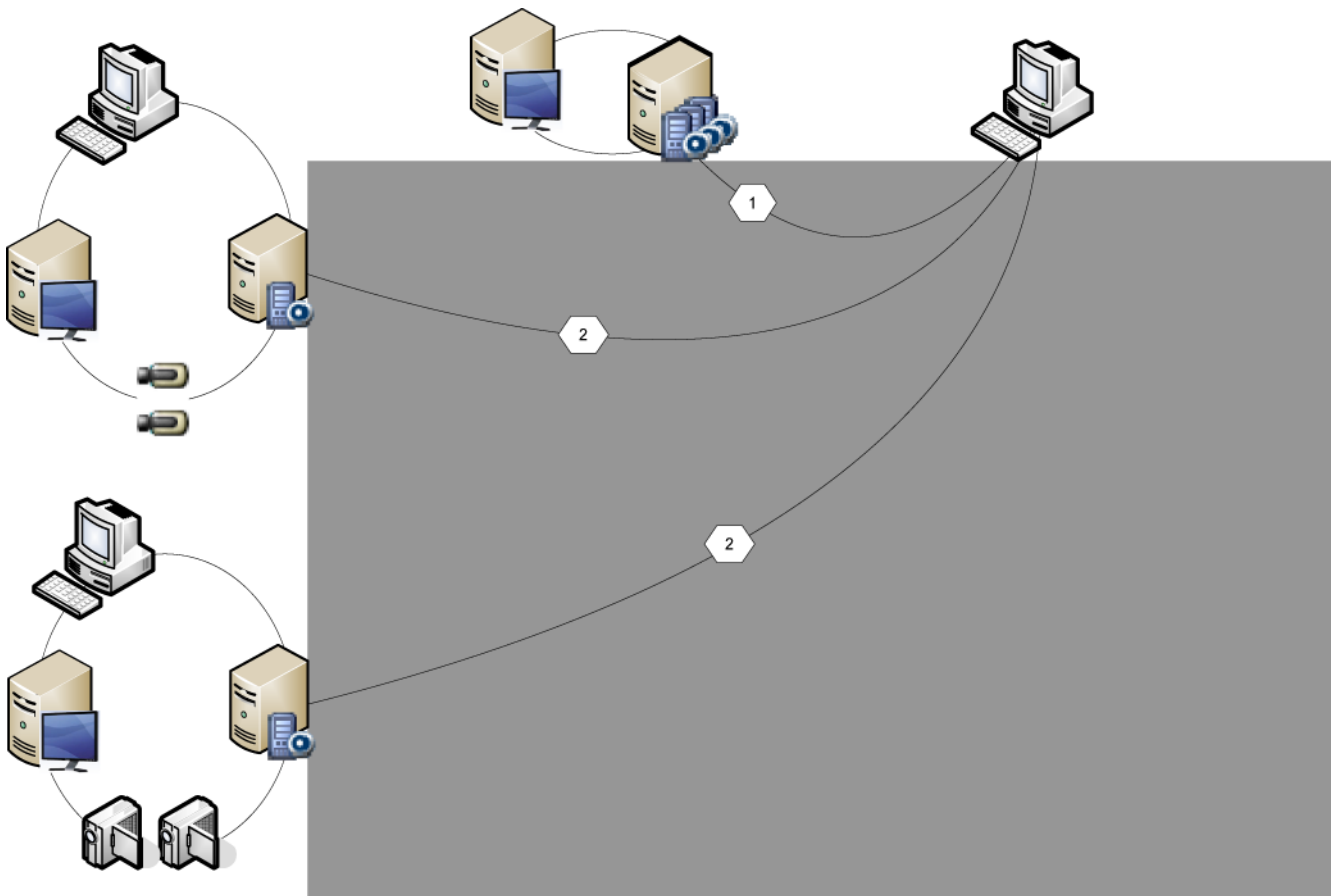

Figure 6.1: Enterprise Scenario 1

You need valid licenses for using an Enterprise System.

6.16.1 Configuring the Server List for Enterprise System



Main window > **Devices > Enterprise System > Server List / Address Book**

You configure multiple Management Server computers in the Server List of an appropriate Management Server.

For simultaneous access you must configure one or more Enterprise User Groups. This changes this Management Server to an Enterprise Management Server.

A user of Operator Client can log on with a user name of an Enterprise User Group to get simultaneous access to the Management Server computers configured in the Server List.



User

Operating permissions are configured on the Enterprise Management Server in **Groups**, Enterprise User Group tab.



User Groups,

Device permissions are configured on each Management Server in Enterprise Access tab.

1. Click  to save the settings.

2. Click  to undo the last setting.



- Click  to activate the configuration.

To add servers:

- Click **Add Server**.
The **Add Server** dialog box is displayed.
- Type in a display name for the server and type in the private network address (DNS name or IP address).
- If required, type in a public network address (DNS name or IP address) for remote access.
- Click **OK**.
- Repeat these steps until you have added all desired Management Server computers.

To add columns:

- ▶ Right-click on the table header and click **Add column**.
You can add up to 10 columns.
To delete a column, right-click the desired column and click **Delete column**.
 - ✓ When you export the Server List, the added columns are also exported.
- The Management Server computers for your Enterprise System are configured.
Now configure the desired Enterprise User Groups and the Enterprise Access.
The following screenshot shows an example:

Management Server	Private Network Address	Public Network Address	Server Number	Server Description
Server01	172.25.23.1	84.60.206.86	1	
Server02	172.25.23.2	84.60.206.85	2	
Server03	172.25.23.3	84.60.206.84	3	

Related Topics

- *Enterprise System* , page 26
- *Server List / Address Book page*, page 234
- *User Groups page*, page 370
- *Using Server Lookup*, page 98

6.16.2

Creating an Enterprise User Group



Main window > **User Groups**

You perform the task of creating an Enterprise User Group for an Enterprise Management system on the Enterprise Management Server.

You create an Enterprise User Group with users to configure their operating permissions. These operating permissions are available on an Operator Client that is connected to the Enterprise Management Server. An example of an operating permission is the user interface of the alarm monitor.

To create an Enterprise User Group:

1. Click the Enterprise User Groups tab.
2. Click .
The **New Enterprise User Group** dialog box is displayed.
3. Type in the name and a description.
4. Click **OK**.
The Enterprise User Group is added to the corresponding tree.
5. Configure the operating permissions and server access for the configured Management Server computers as required.

The following screenshot shows an example:

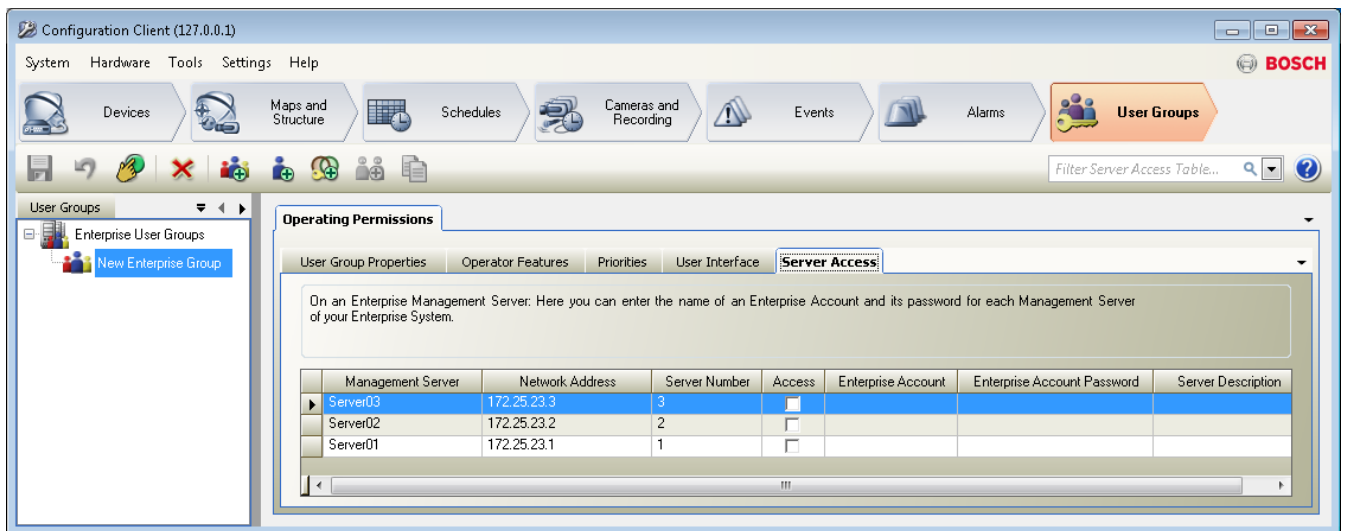

See also

- *User Group Properties page, page 372*
- *Operator Features page, page 381*
- *Priorities page, page 384*
- *User Interface page, page 384*
- *Server Access page, page 385*

6.16.3 Creating an Enterprise Account



Main window > **User Groups**

Caution!

At least one device must be configured in the Device Tree before you can add an Enterprise Account.

You perform the task of creating an Enterprise Account on a Management Server. Repeat this task on each Management Server that is a member of your Enterprise System.

You create an Enterprise Account to configure the device permissions for an Operator Client using an Enterprise System.

To create an Enterprise Account:

1. Click the Enterprise Access tab.

2. Click . The **New Enterprise Account** dialog box is displayed.
3. Type in the name and a description.
4. Click **OK**. The Enterprise Account is added to the corresponding tree.
5. Configure the credentials and the device permissions as required. The following screenshot shows an example:

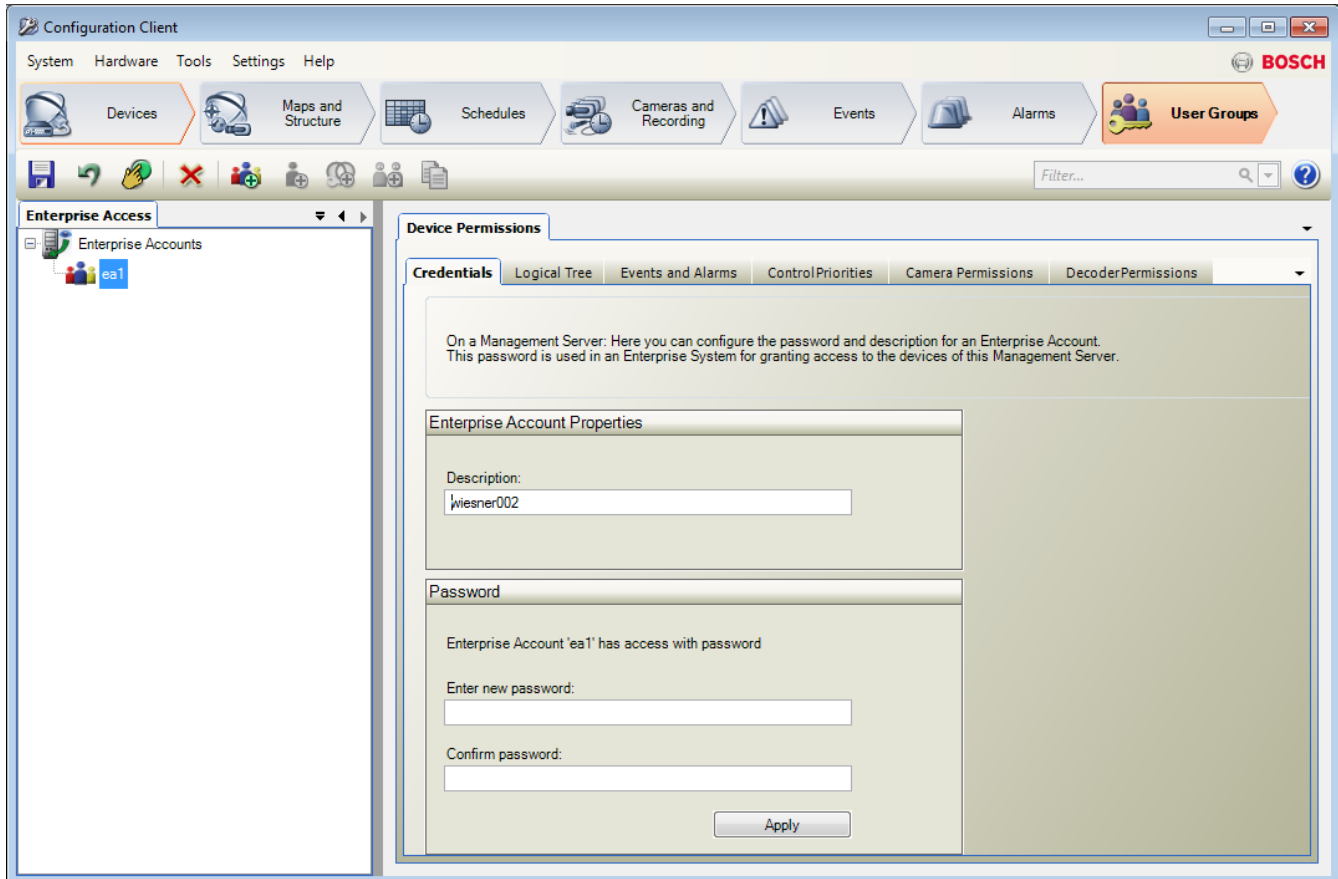

See also

- *Credentials page, page 380*
- *Logical Tree page, page 381*
- *Events and Alarms page, page 378*
- *Control Priorities, page 376*
- *Camera Permissions page, page 375*
- *Decoder Permissions page, page 377*

6.17 Configuring the mounting position of a panoramic camera

Main window >  **Devices** > Expand  > Expand  >  > 

or

Main window >  **Devices** >  > 

or

Main window >  **Devices** >  > 

To configure:

1. Click **Main Settings > Initialization**.
2. In the **Calibration** field, set the mounting position.

See also

- *Viewing modes of a panoramic camera, page 62*

7 Creating an Enterprise System

Perform the following tasks to create an Enterprise System on an Enterprise Management Server and on multiple Management Server computers:

1. *Configuring the Server List for Enterprise System, page 114*
2. *Creating an Enterprise User Group, page 116*
3. *Creating an Enterprise Account, page 116*

This example covers the Scenario 1 described in the *Enterprise System, page 26* chapter:

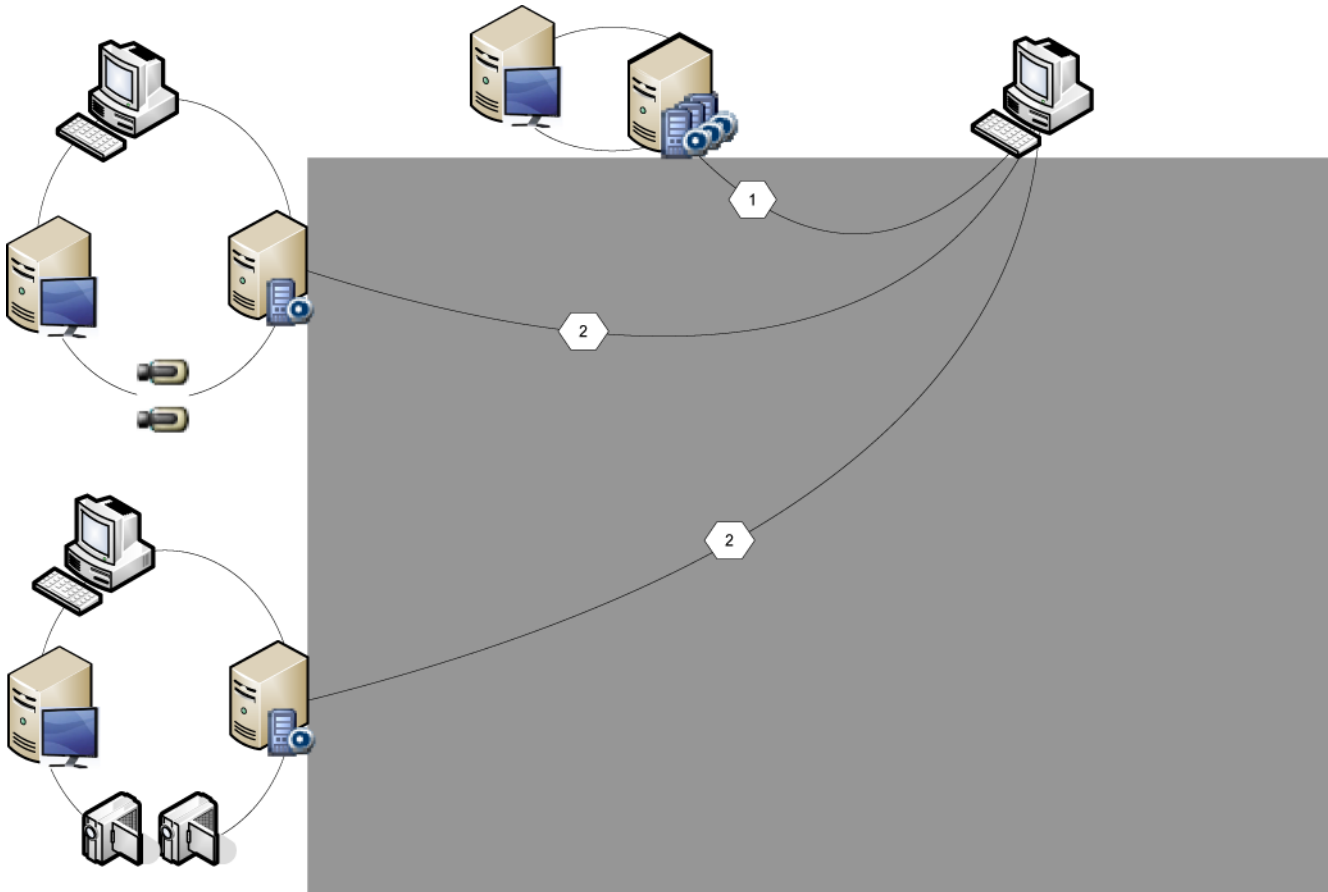

Figure 7.1: Enterprise Scenario 1

You need valid licenses for using an Enterprise System.

7.1 Configuring the Server List for Enterprise System



Main window > **Devices > Enterprise System > Server List / Address Book**

You configure multiple Management Server computers in the Server List of an appropriate Management Server.

For simultaneous access you must configure one or more Enterprise User Groups. This changes this Management Server to an Enterprise Management Server.

A user of Operator Client can log on with a user name of an Enterprise User Group to get simultaneous access to the Management Server computers configured in the Server List.

Operating permissions are configured on the Enterprise Management Server in **Groups**, Enterprise User Group tab.





User



User Groups,

Device permissions are configured on each Management Server in Enterprise Access tab.

1. Click  to save the settings.
2. Click  to undo the last setting.
3. Click  to activate the configuration.

To add servers:

1. Click **Add Server**.
The **Add Server** dialog box is displayed.
2. Type in a display name for the server and type in the private network address (DNS name or IP address).
3. If required, type in a public network address (DNS name or IP address) for remote access.
4. Click **OK**.
5. Repeat these steps until you have added all desired Management Server computers.

To add columns:

- ▶ Right-click on the table header and click **Add column**.
You can add up to 10 columns.
To delete a column, right-click the desired column and click **Delete column**.
- ✓ When you export the Server List, the added columns are also exported.

The Management Server computers for your Enterprise System are configured. Now configure the desired Enterprise User Groups and the Enterprise Access. The following screenshot shows an example:

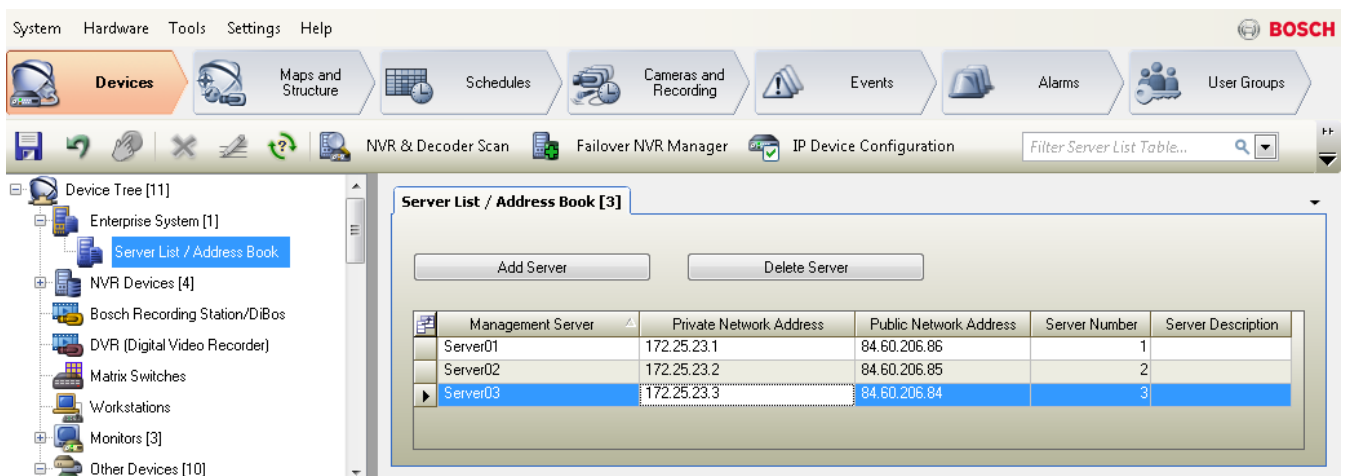

Related Topics

- Enterprise System , page 26
- Server List / Address Book page, page 234
- User Groups page, page 370
- Using Server Lookup, page 98

7.2 Creating an Enterprise User Group



Main window > **User Groups**

You perform the task of creating an Enterprise User Group for an Enterprise Management system on the Enterprise Management Server.

You create an Enterprise User Group with users to configure their operating permissions. These operating permissions are available on an Operator Client that is connected to the Enterprise Management Server. An example of an operating permission is the user interface of the alarm monitor.

To create an Enterprise User Group:

1. Click the Enterprise User Groups tab.
2. Click . The **New Enterprise User Group** dialog box is displayed.
3. Type in the name and a description.
4. Click **OK**. The Enterprise User Group is added to the corresponding tree.
5. Configure the operating permissions and server access for the configured Management Server computers as required.

The following screenshot shows an example:

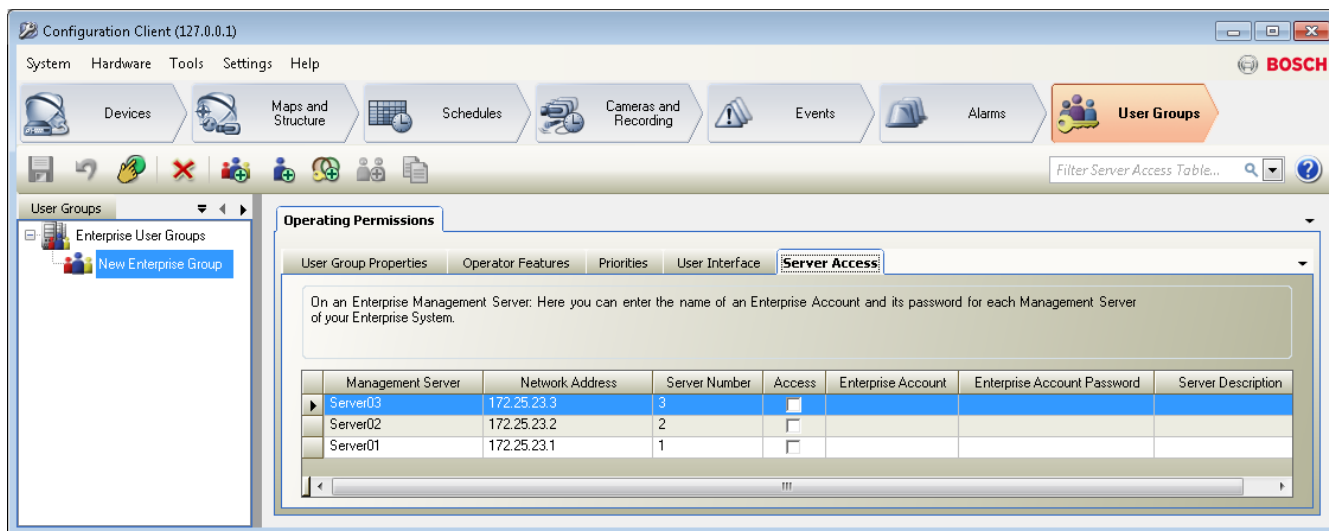

See also

- *User Group Properties page, page 372*
- *Operator Features page, page 381*
- *Priorities page, page 384*
- *User Interface page, page 384*
- *Server Access page, page 385*

7.3 Creating an Enterprise Account



Main window > **User Groups**

Caution!

At least one device must be configured in the Device Tree before you can add an Enterprise Account.

You perform the task of creating an Enterprise Account on a Management Server. Repeat this task on each Management Server that is a member of your Enterprise System.

You create an Enterprise Account to configure the device permissions for an Operator Client using an Enterprise System.

To create an Enterprise Account:

1. Click the Enterprise Access tab.
2. Click .
The **New Enterprise Account** dialog box is displayed.
3. Type in the name and a description.
4. Click **OK**.
The Enterprise Account is added to the corresponding tree.
5. Configure the credentials and the device permissions as required.

The following screenshot shows an example:

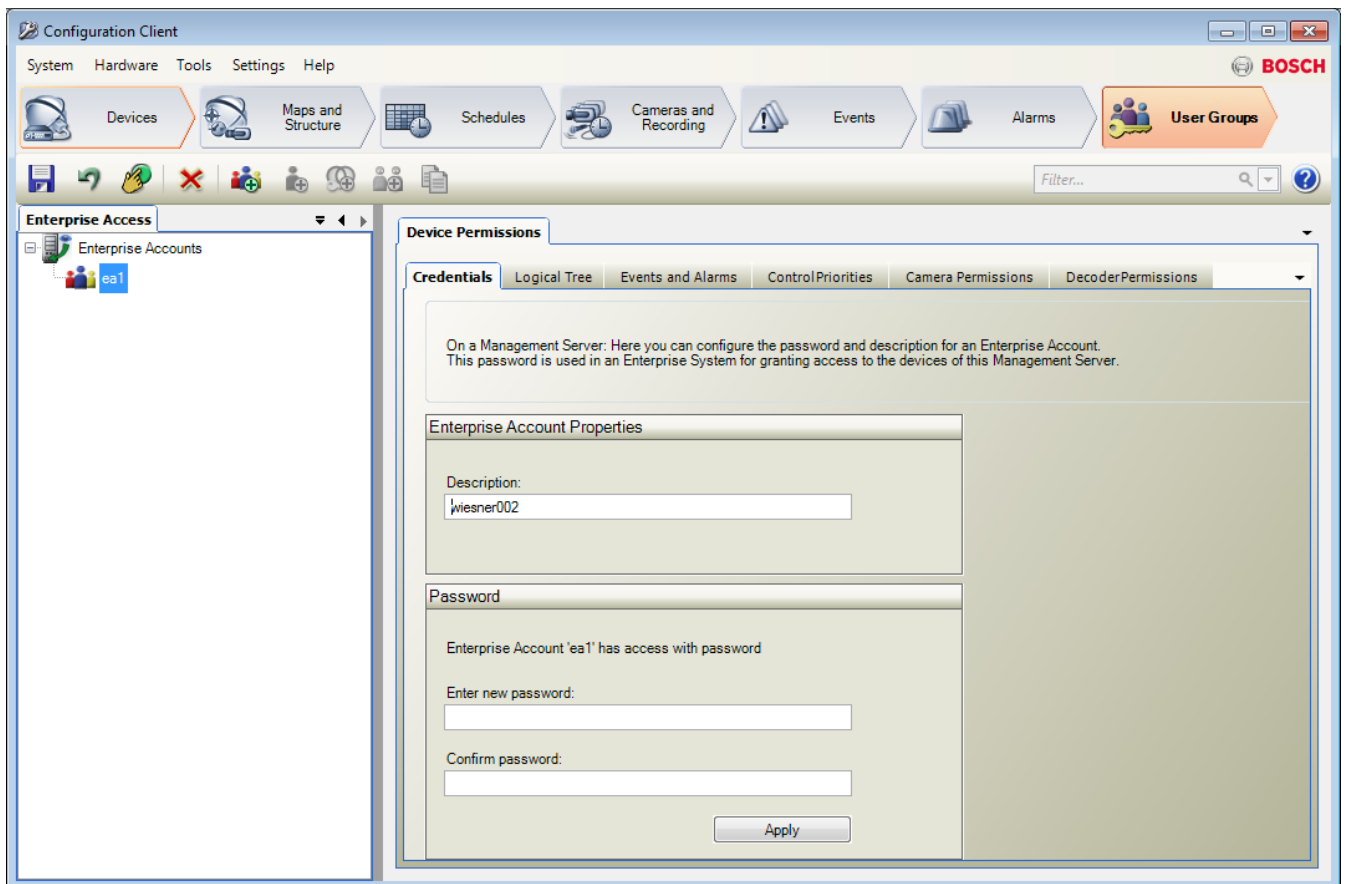

See also

- *Credentials page, page 380*
- *Logical Tree page, page 381*
- *Events and Alarms page, page 378*
- *Control Priorities, page 376*

- *Camera Permissions page, page 375*
- *Decoder Permissions page, page 377*

8 Configuring the Server List for Enterprise System



Main window > **Devices > Enterprise System > Server List / Address Book**

You configure multiple Management Server computers in the Server List of an appropriate Management Server.

For simultaneous access you must configure one or more Enterprise User Groups. This changes this Management Server to an Enterprise Management Server.



A user of Operator Client can log on with a user name of an Enterprise User Group to get simultaneous access to the Management Server computers configured in the Server List.



Operating permissions are configured on the Enterprise Management Server in **User Groups**, Enterprise User Group tab.



Device permissions are configured on each Management Server in **User Groups**, Enterprise Access tab.

1. Click  to save the settings.
2. Click  to undo the last setting.
3. Click  to activate the configuration.

To add servers:

1. Click **Add Server**.
The **Add Server** dialog box is displayed.
2. Type in a display name for the server and type in the private network address (DNS name or IP address).
3. If required, type in a public network address (DNS name or IP address) for remote access.
4. Click **OK**.
5. Repeat these steps until you have added all desired Management Server computers.

To add columns:

- ▶ Right-click on the table header and click **Add column**.
You can add up to 10 columns.
To delete a column, right-click the desired column and click **Delete column**.
- ✓ When you export the Server List, the added columns are also exported.

The Management Server computers for your Enterprise System are configured. Now configure the desired Enterprise User Groups and the Enterprise Access. The following screenshot shows an example:

The screenshot displays the Bosch Video Management System interface. The top navigation bar includes 'System', 'Hardware', 'Tools', 'Settings', and 'Help'. Below this is a secondary navigation bar with icons for 'Devices', 'Maps and Structure', 'Schedules', 'Cameras and Recording', 'Events', 'Alarms', and 'User Groups'. A toolbar below the navigation bar contains icons for 'NVR & Decoder Scan', 'Failover NVR Manager', and 'IP Device Configuration', along with a search box labeled 'Filter Server List Table...'. The main interface is divided into a 'Device Tree' on the left and a 'Server List / Address Book [3]' window on the right. The 'Device Tree' shows a hierarchy: 'Enterprise System [1]' containing 'Server List / Address Book', 'NVR Devices [4]', 'Bosch Recording Station/DiBos', 'DVR (Digital Video Recorder)', 'Matrix Switches', 'Workstations', 'Monitors [3]', and 'Other Devices [10]'. The 'Server List / Address Book' window features 'Add Server' and 'Delete Server' buttons and a table with the following data:

Management Server	Private Network Address	Public Network Address	Server Number	Server Description
Server01	172.25.23.1	84.60.206.86	1	
Server02	172.25.23.2	84.60.206.85	2	
Server03	172.25.23.3	84.60.206.84	3	

Related Topics



- *Enterprise System* , page 26
- *Server List / Address Book page*, page 234
- *User Groups page*, page 370
- *Using Server Lookup*, page 98

9 Configuring Server Lookup



Main window > **Devices > Enterprise System > Server List / Address Book**

For Server Lookup, the user of Operator Client or Configuration Client logs on with a user name of a normal user group, not as a user of an Enterprise User Group.

1. Click  to save the settings.
2. Click  to undo the last setting.
3. Click  to activate the configuration.

To add servers:

1. Click **Add Server**.
The **Add Server** dialog box is displayed.
2. Type in a display name for the server and type in the private network address (DNS name or IP address).
3. If required, type in a public network address (DNS name or IP address) for remote access.
4. Click **OK**.
5. Repeat these steps until you have added all desired Management Server computers.

To add columns:

- ▶ Right-click on the table header and click **Add column**.
You can add up to 10 columns.
To delete a column, right-click the desired column and click **Delete column**.
- ✓ When you export the Server List, the added columns are also exported.

The Management Server computers for Server Lookup are configured.
The following screenshot shows an example:

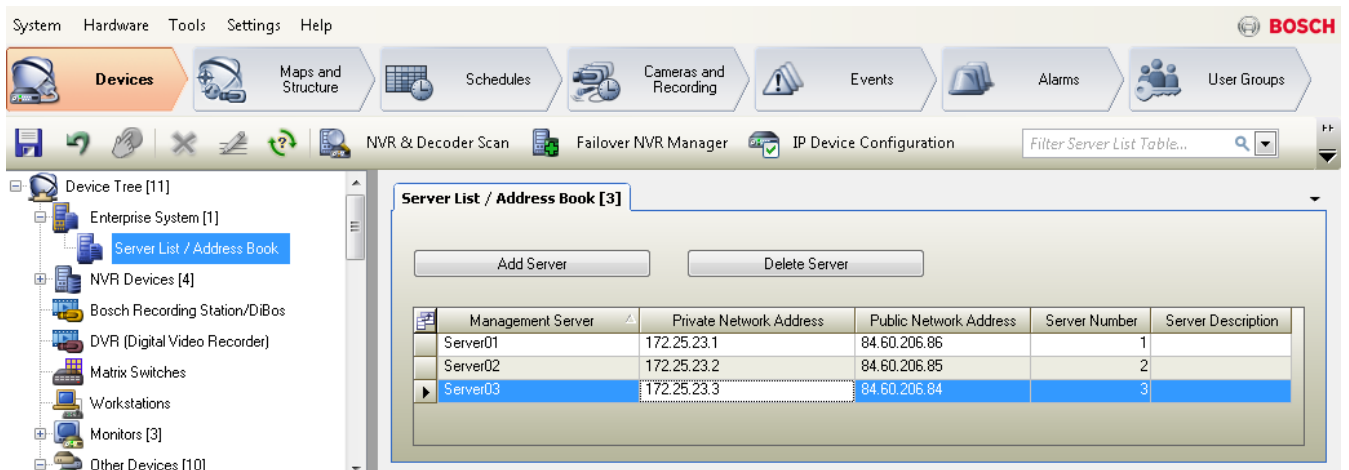

Related Topics

- *Server Lookup* , page 33
- *Server List / Address Book* page, page 234
- *Using Server Lookup*, page 98

9.1 Exporting the Server List



Main window >  **Devices > Enterprise System > Server List / Address Book**

You can export the Server List with all configured properties for editing and later import.

When you edit the exported csv file in an external editor, note the limitations described in the *Server List*, page 35 chapter.

To export:

1. Right-click on the table header and click **Export Server List....**
 2. Type in a name for the export file and click **Save**.
- ✓ All columns of the Server List are exported as a csv file.

Related Topics

- *Server Lookup* , page 33
- *Server List*, page 35
- *Server List / Address Book page*, page 234

9.2 Importing a Server List



Main window >  **Devices > Enterprise System > Server List / Address Book**

When you have edited the exported csv file in an external editor, note the limitations described in the *Server List*, page 35 chapter.

To import:

1. Right-click on the table header and click **Import Server List....**
2. Click the desired file and click **Open**.

Related Topics

- *Server Lookup* , page 33
- *Server List*, page 35
- *Server List / Address Book page*, page 234

10 Adding an unmanaged site



Main window > **Devices** >

You can add a video network device to the **Unmanaged Sites** item of the Device Tree.

It is assumed that all unmanaged network devices of an unmanaged site are located in the same time zone.

To create:

1. Right-click  and then click **Add Unmanaged Site**.
The **Add Unmanaged Site** dialog box is displayed.
2. Type in a site name and a description.
3. In the **Time zone** list, select the appropriate entry.
4. Click **OK**.
A new unmanaged site is added to the system.
5. Right-click this item and then click **Add Unmanaged Network Device**.
The **Add Unmanaged Network Device** dialog is displayed.
6. Select the desired device type.
7. Type in a valid IP address and credentials for this device.
8. Click **OK**.
You can now add this unmanaged site to the Logical Tree.
Please note that only the site is visible in the Logical Tree but not the network devices belonging to this site.

See also

- *Add Unmanaged Network Device dialog box*, page 288
- *Unmanaged Sites page*, page 287
- *Unmanaged site*, page 31

10.1 Importing unmanaged sites



Main window > **Devices** >

You can import a CSV file containing a configuration of a DVR or another Bosch VMS that you want to import in your Bosch VMS as an unmanaged site.

To import:

1. Right-click  and then click **Import Unmanaged Sites**.
2. Click the desired file and click **Open**.
One or more new unmanaged site is added to the system.
You can now add these unmanaged sites to the Logical Tree.
Note: If an error occurs and the file cannot be imported, an error message informs you accordingly.

See also

- *Structure of CSV file for importing unmanaged sites*, page 32

10.2 Configuring the time zone



Main window >  **Devices** > Expand  > 

You can configure the time zone of an unmanaged site. This is useful when a user of Operator Client wants to access an unmanaged site using a computer with Operator Client located in another time zone than this unmanaged site.

To configure the time zone:

- ▶ In the **Time zone** list, select the appropriate entry.



See also

- *Unmanaged Sites page, page 287*

11 Managing VRM storage

Main window >  **Devices** > 

This chapter provides information on how to configure the VRM storage in your system.

1. Click  to save the settings.
2. Click  to undo the last setting.
3. Click  to activate the configuration.

11.1 Synchronizing Bosch VMS configuration

Main window >  **Devices** > Expand  > Right-click  > **Synchronize Bosch VMS Configuration** command

As of Bosch VMS 6.0, VRM 3.50 is supported. When you do not upgrade VRM to version 3.50 during the upgrade to Bosch VMS 6.0, recording continues but you cannot change the configuration of the old VRM.

If you upgraded your VRM software to version 3.50, you must manually synchronize the Bosch VMS configuration.

11.2 Scanning for VRM devices

Main window >  **Devices** > 

In your network, you need a VRM service running on a computer, and an iSCSI device.

Caution!

When you add an iSCSI device with no targets and LUNs configured, start a default configuration and add the IQN of each encoder to this iSCSI device.

When you add an iSCSI device with targets and LUNs pre-configured, add the IQN of each encoder to this iSCSI device.

See *Configuring an iSCSI device*, page 130 for details.

The system supports you with a scan for devices.

To add VRM devices via scan:

1. Right-click  and click **Scan for VRM Devices**.
The **Bosch VMS Scan Wizard** dialog box is displayed.
2. Select the desired check boxes for the devices that you want to add.
3. In the **Role** list, select the desired role.
It depends on the current type of the VRM device which new role you can select.
If you select **Mirrored** or **Failover**, the next configuration step is additionally required.
4. Click **Next >**.
5. In the **Master VRM** list, select the Master VRM for the selected Mirrored or Failover VRM.

6. Click **Next >>**.
The **Authenticate Devices** dialog box of the wizard is displayed.
7. Type in the password for each device that is protected by a password.
Password check is performed automatically, when you do not enter a further character in the password field for a few seconds or you click outside the password field.
If the passwords of all devices are identical, you can enter it in the first **Password** field.
Then right-click this field and click **Copy cell to column**.



In the **Status** column, the successful logons are indicated with



The failed logons are indicated with



8. Click **Finish**.
The device is added to your Bosch VMS.

See also

- *Bosch VMS Scan Wizard, page 267*
- *VRM Devices page, page 269*
- *Configuring an iSCSI device, page 130*
- *Dual / failover recording, page 40*

11.3 Adding a Primary VRM manually



Main window >  **Devices** > Right-click  > Click **Add VRM** > **Add VRM** dialog box
You can add a Primary VRM device manually if you know the IP address and password.

To add a Primary VRM device:

1. Make the required settings for your VRM device.
2. In the **Type** list, select the **Primary** entry.
3. Click **OK**.

The VRM device is added.

See also

- *Add VRM dialog box, page 270*
- *Dual / failover recording, page 40*

11.4 Adding a Secondary VRM manually



Main window >  **Devices** > Right-click  > Click **Add VRM** > **Add VRM** dialog box



Notice!

For configuring a Secondary VRM you must first install the appropriate software on the desired computer. Run Setup.exe and select **Secondary VRM**.

You can add a Secondary VRM device manually if you know the IP address and password.

To add a Secondary VRM device:

1. Make the required settings for your VRM device.
2. In the **Type** list, select the **Secondary** entry.
3. Click **OK**.

The VRM device is added.
You can now configure the Secondary VRM like any Primary VRM.

See also

- *Add VRM dialog box, page 270*
- *Dual / failover recording, page 40*

11.5 Adding a Mirrored VRM manually

Main window >  **Devices** > Expand  > Right-click  > Click **Add Mirrored VRM** > **Add VRM** dialog box



Notice!

For configuring a Secondary VRM you must first install the appropriate software on the desired computer. Run Setup.exe and select **Secondary VRM**.

Only a Secondary VRM can take over the role of a Mirrored VRM. You add a Mirrored VRM to a Primary VRM.

You can add a Mirrored VRM device manually if you know the IP address and password. The initially selected VRM is the Master VRM for this Mirrored VRM.

To add a Mirrored VRM device:



1. Make the required settings for your VRM device.
2. Ensure that the correct Master VRM is selected. If not, cancel this procedure.
3. Click **OK**.

The Mirrored VRM device is added to the selected Primary VRM.

See also

- *Add VRM dialog box, page 270*
- *Dual / failover recording, page 40*

11.6 Adding a Failover VRM manually

Main window >  **Devices** > Expand  > Right-click  > Click **Add Failover VRM** > **Add Failover VRM** dialog box



Notice!

For configuring a Secondary VRM you must first install the appropriate software on the desired computer. Run Setup.exe and select **Secondary VRM**.

Either a Primary VRM or a Secondary VRM can take over the role of a Failover VRM. You add a Primary Failover VRM to a Primary VRM or you add a Secondary Failover VRM to a Secondary VRM.

You can add a Failover VRM device manually if you know the IP address and password. The initially selected VRM is the Master VRM for this Failover VRM.

You can effectively assign a Failover VRM to a Master VRM only when both are online and are successfully authenticated. The passwords are then synchronized.

To add a Failover VRM device:

1. Make the required settings for your VRM device.
 2. Ensure that the correct Master VRM is selected. If not, cancel this procedure.
 3. Click **OK**.
- ✓ The Failover VRM device is added to the selected Master VRM.

See also

- *Add Failover VRM dialog box, page 271*
- *Dual / failover recording, page 40*

11.7**Adding a VRM pool**

Main window >  **Devices** > Expand 

To add a VRM pool:

- ▶ Right-click  or  and click **Add Pool**.
A new pool is added to the system.

See also

- *iSCSI storage pool, page 38*



11.8**Adding an iSCSI device**

Main window >  **Devices** > Expand  > Expand  > 

To add an iSCSI device:

1. Right-click  and click **Add iSCSI Device**.
The **Add iSCSI Device** dialog box is displayed.
2. Type the desired display name, the network address of an iSCSI device, and the device type and click **OK**.
The iSCSI device is added to the selected VRM pool.
If required, add targets and LUNs.

11.9**Configuring automatic recording mode on a pool**

Main window >  **Devices** > Expand  > Expand  > 

Notice:

If you have configured a failover recording mode earlier, this configuration is overwritten.

To configure:

- ▶ In the **Recording preferences mode** list, select **Automatic**.
After activation of the configuration the **Automatic** recording mode is active. On the **Recording Preferences** page of an encoder, the primary and the secondary target list are disabled.

Related Topics

- *Configuring failover recording mode on an encoder, page 139*

11.10 Adding a DSA E-Series iSCSI device



You can either add an E-Series iSCSI device that is already initialized or you add an E-Series iSCSI device that is not initialized.

You can add LUNs larger than 2 TB if the pool is enabled for large LUNs.

LUNs larger than 2 TB ("large LUNs") are not supported by the following devices:

- VRM devices earlier than 3.60
- VSG devices with firmware version earlier than 6.30
- Encoders with firmware version earlier than 6.30

Bosch VMS prevents you to perform the following procedures:

- Add or move devices with firmware version earlier than 6.30 to a pool that allows large LUNs.
- Add or move devices that are currently not connected to the network, to a pool that allows large LUNs.
- Add or move an iSCSI device that contains large LUNs, to a pool that does not allow large LUNs.
- Allow large LUNs on a pool that contains devices with firmware version earlier than 6.30.
- Disable large LUNs on a pool with an iSCSI device that contains large LUNs.

Please move devices with firmware earlier than 6.30 to a pool that does not allow large LUNs.

To add an initialized iSCSI device:

1. Right-click  and then click **Add DSA E-Series Device**.
The **Add DSA E-Series Device** dialog box is displayed.
2. Type in the management IP address and the password.
3. Click **Connect**.
If connection is established, the fields in the **Controller** group and/or the **2nd Controller** group are filled.
4. Click **OK**.
The device is added to the system.
The available targets are automatically scanned and the LUNS are displayed.
You can use the iSCSI device.
If the pool is enabled for large LUNs, and the iSCSI device has large LUNs configured, the **Large LUN** column displays a checkmark for the affected LUNs.

To add a not initialized iSCSI device:

1. Right-click  and then click **Add DSA E-Series Device**.
The **Add DSA E-Series Device** dialog box is displayed.
2. Type in the management IP address and the password.
3. Click **Connect**.
If connection is established, the fields in the **Controller** group and/or the **2nd Controller** group are filled.
4. Click **OK**.
The device is added to the system.

5. Click  and then click .
6. Click the **Basic Configuration** tab.

7. Type in the desired LUN capacity.
If you type in a value larger than 2 TB, you must enable your pool for LUNs larger than 2 TB.
8. Click **Initialize**.
The LUNs are created.
9. Click **Close**.
10. Right-click the iSCSI device, and then click **Scan Target**.
The LUNs are displayed with an unknown state.
11. Save and activate the configuration.
12. Format all LUNs.
13. If you added an iSCSI device with dual controller, remove the desired LUNs from the first controller, right-click the second controller, and click **Scan Target** to add these LUNs.

See also

- *Add DSA E-Series Device dialog box, page 278*
- *Basic Configuration page, page 279*
- *Formatting a LUN, page 133*

11.11 Configuring an iSCSI device

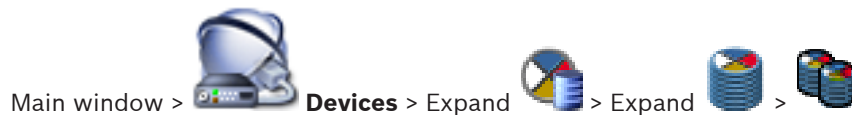

After adding VRM devices, iSCSI devices, and encoders, perform the following tasks to ensure that video data of encoders is stored on the iSCSI devices or video data can be retrieved from these iSCSI devices:

- Execute the default configuration to create LUNs on each target of the iSCSI device.
This step is optional. You do not need to perform this step on an iSCSI device with LUNs pre-configured.
- Scan the iSCSI device to add the targets and LUNs to the Device Tree after default configuration.



Note:

Not all iSCSI devices support the default configuration and automatic IQN mapping.

Prerequisite:

The iSCSI device must be configured with valid IP addresses.

To perform basic configuration of an DSA E-Series iSCSI device:

- ▶ Expand the appropriate VRM device  and , click the appropriate iSCSI device .







1. Click the **Basic Configuration** tab.
2. Type in the desired LUN capacity.
If you type in a value larger than 2 TB, you must enable your pool for LUNs larger than 2 TB.
3. Click **Initialize**.
The LUNs are created.
4. Click **Close**.
5. Right-click the iSCSI device, and then click **Scan Target**.
The LUNs are displayed with an unknown state.
6. Save and activate the configuration.

7. Format all LUNs.
8. If you added an iSCSI device with dual controller, remove the desired LUNs from the first controller, right-click the second controller, and click **Scan Target** to add these LUNs.

To perform basic configuration on other iSCSI devices:

1. Click the **Basic Configuration** tab.
2. Type in the desired LUN count.
3. Click **Set**.
The LUNs are created.
4. Click **Close**.
5. Right-click the iSCSI device, and then click **Scan Target**.
The LUNs are displayed with an unknown state.
6. Save and activate the configuration.
7. Format all LUNs.

To perform IQN mapping for other iSCSI devices:

1. Expand the appropriate VRM device  and , click the appropriate iSCSI device .
2. Right-click  and click **Map IQNs**.
The iqn-Mapper dialog box is displayed and the process is started.
The encoders that are assigned to the selected VRM device are evaluated and their IQNs are added to this iSCSI device.
3. Click  to save the settings.
4. Click  to activate the configuration.

See also

- *Basic Configuration page, page 279*
- *Load Balancing dialog box, page 279*
- *iqn-Mapper dialog box, page 280*
- *Formatting a LUN, page 133*

11.12 Moving an iSCSI system to another pool

Main window > **Devices** > Expand  > Expand  > Expand  > 

You move a device from one pool to another within the same VRM device without any recording loss.

To move:

1. Right-click  and click **Change Pool ...**.
The **Change pool** dialog box is displayed.
2. In the **New Pool:** list, select the desired pool.
3. Click **OK**.
The device is moved to the selected pool.

See also

- *Change Pool for dialog box, page 276*

11.13 Adding a LUN



Main window > **Devices** > Expand



Usually the network scan adds the desired iSCSI devices with their targets and LUNs automatically. If your network scan did not work correctly or you want to configure your iSCSI device offline before it is actually integrated into your network, you configure a target in your iSCSI device and on this target you configure one or more LUNs.

You can add LUNs larger than 2 TB if the pool is enabled for large LUNs.

LUNs larger than 2 TB ("large LUNs") are not supported by the following devices:

- VRM devices earlier than 3.60
- VSG devices with firmware version earlier than 6.30
- Encoders with firmware version earlier than 6.30

Bosch VMS prevents you to perform the following procedures:

- Add or move devices with firmware version earlier than 6.30 to a pool that allows large LUNs.
- Add or move devices that are currently not connected to the network, to a pool that allows large LUNs.
- Add or move an iSCSI device that contains large LUNs, to a pool that does not allow large LUNs.
- Allow large LUNs on a pool that contains devices with firmware version earlier than 6.30.
- Disable large LUNs on a pool with an iSCSI device that contains large LUNs.

Please move devices with firmware earlier than 6.30 to a pool that does not allow large LUNs.

To add:

1. If required, click to select **Allow LUNs larger than 2 TB**.

2. Right-click  and click **Scan Target**.

The target  is added.

3. Click the target.
The **LUNs** page is displayed.
4. Click **Add**.

The **Add LUN** dialog box is displayed.

5. Enter the desired LUN number and click **Ok**.
The LUN is added as a new row in the table.
Repeat this step for each desired LUN.

Notes:

- To remove a LUN, click **Remove**.
The video data remains on this LUN.
- To format a LUN, click **Format LUN**.
All data on this LUN is removed!

See also

- *Pool page, page 272*
- *LUNs page, page 281*
- *Add LUN dialog box, page 281*

11.14 Formatting a LUN



You format a LUN to prepare it for the first use.



Notice!

All data on the LUN is lost after formatting.

To configure:

1. Select the desired LUN and, in the **Format** column, click to check.
2. Click **Format LUN**.
3. Read the displayed message carefully and confirm the message if desired.
The selected LUN is formatted. All data on this LUN is lost.

See also

- *LUNs page, page 281*

11.15 Changing the password of a VRM device



To change the password:

1. Right-click and click **Change VRM Password**.
The **Change Password** dialog box is displayed.
 2. In the **Old Password** field, type in the appropriate password.
 3. In the **New Password** field, type in the new password and click and repeat this entry in the second **New Password** field.
 4. Click **OK**.
 5. Confirm the next dialog box.
- ✓ The password is changed immediately on the device.

11.16 Configuring dual recording in the Device Tree



You must disable the ANR function to configure dual recording.

If you configure dual recording for one camera of a multi-channel encoder, the system ensures that the same recording target is configured for all cameras of this encoder.

You can configure dual recording by assigning encoders that are recorded by a Primary VRM to a Secondary VRM. This is for example useful when you want to assign only a part of the encoders that are recorded by a Primary VRM.

A Secondary VRM must already be added.

To configure:

1. Right-click  and click **Add Encoder from Primary VRM**.
The **Add Encoders** dialog box is displayed.
2. Click to select the desired encoders.
When you select a pool or a VRM, all child items are automatically selected.
3. Click **OK**.
The selected encoders are added to the Secondary VRM.

See also

- *Configuring dual recording in the Camera Table, page 194*
- *Configuring the ANR function, page 194*
- *Dual / failover recording, page 40*
- *Adding a Secondary VRM manually, page 126*

12 Managing encoders / decoders





Main window > **Devices**

This chapter provides information on how to configure the devices in your system.

Changing the Device Tree impacts other pages of the Configuration Client:



- **Maps and Structure**
With the devices of the Device Tree you create a user defined structure called Logical Tree. Hence, if you remove a device from the Device Tree, this device is automatically removed from the Logical Tree. But adding a device to the Device Tree does not add this device to the Logical Tree.
- **Cameras and Recording**
All cameras of the Device Tree are available in the Camera Table and the Recording Tables. You cannot modify DiBos or Bosch Allegiant cameras.
- **Events**
All devices of the Device Tree are available in the corresponding Event Tables.
- **User Groups**
You can reduce the functional range of the devices on several permission pages (per user group or Enterprise Account).

This chapter provides information on how to configure the encoders and decoders in your system.

1. Click  to save the settings.
2. Click  to undo the last setting.
3. Click  to activate the configuration.

12.1 Adding an encoder to a VRM pool



Main window > **Devices** > Expand  > Expand  > 

The system supports you with a scan for devices.

To add encoders via scan:

1. Right-click  and click **Scan for Encoders**.
The **Bosch VMS Scan Wizard** dialog box is displayed.
2. Select the required encoders, select the desired VRM pool and click **Assign** to assign them to the VRM pool.
3. Click **Next >>**.
The **Authenticate Devices** dialog box of the wizard is displayed.
4. Type in the password for each device that is protected by a password.
Password check is performed automatically, when you do not enter a further character in the password field for a few seconds or you click outside the password field.
If the passwords of all devices are identical, you can enter it in the first **Password** field.

Then right-click this field and click **Copy cell to column**.

In the **Status** column, the successful logons are indicated with .

The failed logons are indicated with .

5. Click **Finish**.

The device is added to your Bosch VMS.

See also

- *Bosch VMS Scan Wizard, page 267*

12.2

Moving an encoder to another pool

Main window > **Devices** > Expand  > Expand  >  > 

You move a device from one pool to another within the same VRM device without any recording loss.

To move:

1. Right-click  and click **Change Pool**
The **Change pool** dialog box is displayed.
2. In the **New Pool:** list, select the desired pool.
3. Click **OK**.
The device is moved to the selected pool.

See also

- *Change Pool for dialog box, page 276*

12.3

Adding a live only encoder

Main window >  **Devices** > 

The system supports you with a scan for devices.

To add Bosch live only devices via scan:

1. Right-click  and click **Scan for Live Only Encoders**.
The **Bosch VMS Scan Wizard** dialog box is displayed.
2. Select the desired check boxes for the devices that you want to add.
3. Click **Next >>**.
The **Authenticate Devices** dialog box of the wizard is displayed.
4. Type in the password for each device that is protected by a password.
Password check is performed automatically, when you do not enter a further character in the password field for a few seconds or you click outside the password field.
If the passwords of all devices are identical, you can enter it in the first **Password** field.
Then right-click this field and click **Copy cell to column**.

In the **Status** column, the successful logons are indicated with .

The failed logons are indicated with .

5. Click **Finish**.
The device is added to your Bosch VMS.

To add ONVIF live only devices via scan:

1. Right-click  and click **Scan for Live Only ONVIF Encoders**.
The **Bosch VMS Scan Wizard** dialog box is displayed.
2. Select the desired check boxes for the devices that you want to add.
3. Click **Next >>**.
The **Authenticate Devices** dialog box of the wizard is displayed.
4. Type in the password for each device that is protected by a password.
Password check is performed automatically, when you do not enter a further character in the password field for a few seconds or you click outside the password field.
If the passwords of all devices are identical, you can enter it in the first **Password** field.
Then right-click this field and click **Copy cell to column**.

In the **Status** column, the successful logons are indicated with .

The failed logons are indicated with .

5. Click **Finish**.
The device is added to your Bosch VMS.

See also

- *Bosch VMS Scan Wizard, page 267*
- *Live Only page, page 286*

12.4 Adding a local storage encoder

Main window >  **Devices** > 

The system supports you with a scan for devices.

To add local storage encoders via scan:

1. Right-click  and click **Scan for Local Storage Encoders**.
The **Bosch VMS Scan Wizard** dialog box is displayed.
2. Select the desired check boxes for the devices that you want to add.
3. Click **Next >>**.
The **Authenticate Devices** dialog box of the wizard is displayed.
4. Type in the password for each device that is protected by a password.
Password check is performed automatically, when you do not enter a further character in the password field for a few seconds or you click outside the password field.
If the passwords of all devices are identical, you can enter it in the first **Password** field.
Then right-click this field and click **Copy cell to column**.

In the **Status** column, the successful logons are indicated with .

The failed logons are indicated with .

5. Click **Finish**.
The device is added to your Bosch VMS.

See also

- *Bosch VMS Scan Wizard, page 267*
- *Local Storage page, page 287*

12.5**Configuring an encoder / decoder****To configure an encoder:**

Main window >  **Devices** > Expand  > Expand  >  > 

or

Main window >  **Devices** > Expand  > Expand  > Expand  > 



or

Main window >  **Devices** >  > 

or

Main window >  **Devices** >  > 

To configure a decoder:

Main window >  **Devices** > Expand  > Expand  > 

See the Online Help for the  pages for details.

**Notice!**

IP devices can be connected that do not have all configuration pages that are described here.

See also

- *Bosch Encoder / Decoder page, page 290*

12.6**Updating the device capabilities**

Main window >  **Devices** > Expand  > Expand  > Right-click  > Click **Edit Encoder** > **Edit Encoder** dialog box

or

Main window >  **Devices** > Right-click  > Click **Edit Encoder** > **Edit Encoder** dialog box

or

 Main window >  **Devices** > Right-click  > Click **Edit Encoder** > **Edit Encoder** dialog box
 or

 Main window >  **Devices** > Expand  > Expand  > Right-click  > Click **Edit Encoder** > **Edit Encoder** dialog box
 or

 Main window >  **Devices** > Expand  > Right-click  > Click **Edit Decoder** > **Edit Decoder** dialog box

After an upgrade of the device, you can update its device capabilities. A message text informs you whether the retrieved device capabilities match the device capabilities stored in Bosch VMS.

To update:







1. Click **OK**.
 A message box is displayed with the following text:
If you apply the device capabilities, the recording settings and the event settings for this device may change. Check these settings for this device.
2. Click **OK**.
 The device capabilities are updated.

See also

- *Edit Encoder / Edit Decoder dialog box, page 247*

12.7

Configuring failover recording mode on an encoder

 Main window >  **Devices** > Expand  > Expand  >  > 

Prerequisites: On the **Pool** page, in the **Recording preferences mode** list, select **Failover**. If **Automatic** is selected, the settings are performed automatically and cannot be configured. If you want to use a secondary target for both automatic or failover mode: On the **Pool** page, in the **Secondary target usage** list, select **On**.

It is recommended to configure at least 2 iSCSI devices for failover mode.

To configure:

1. Click **Advanced Settings**.
2. Click **Recording Preferences**.
3. Under **Primary target**, select the entry for the required target. All storage systems entered under **Storage Systems** will be shown in the list.
4. Under **Secondary target**, select the entry for the required target. All storage systems entered under **Storage Systems** are displayed in the list.
 The changes are active immediately. An activation is not required.

Related Topics

- *Configuring automatic recording mode on a pool, page 128*

12.8 Configuring multiple encoders / decoders

Main window

You can modify the following properties of multiple encoders and decoders at once:

- Display names
- IP addresses
- Firmware versions



Notice!

Changing the IP address of an IP device can make it unreachable.

To configure multiple IP addresses:

1. On the **Hardware** menu, click **IP Device Configuration....** The **IP Device Configuration** dialog box is displayed.
2. Select the required devices. You can select multiple devices by pressing the CTRL- or the SHIFT-key.
3. Right-click the selected devices and click **Set IP Addresses....** The **Set IP Addresses** dialog box is displayed.
4. In the **Start with:** field, type the first IP address.
5. Click **Calculate**. In the **End with:** field, the last IP address of the range for the selected devices is displayed.
6. Click **OK**.
7. In the **IP Device Configuration...** dialog box, click **Apply**.
The new IP addresses are updated in the selected devices.

To configure multiple display names:

1. On the **Hardware** menu, click **IP Device Configuration....** The **IP Device Configuration** dialog box is displayed.
2. Select the required devices. Multiple selection is possible by pressing the SHIFT key.
3. Right-click the selected devices and click **Set Display Names...** The **Set Display Names** dialog box is displayed.
4. In the **Start with:** field, type the first string.
5. Click **Calculate**. In the **End with:** field, the last string of the range for the selected devices is displayed.
6. Click **OK**.
7. In the **IP Device Configuration...** dialog box, click **Apply**.
The calculated names are updated in the selected devices.

To update firmware for multiple devices:

1. On the **Hardware** menu, click **IP Device Configuration....** The **IP Device Configuration** dialog box is displayed.
2. Select the required devices.
3. Click **Update Firmware**.
4. Select the file containing the update.
5. Click **OK**.

12.9 Changing the password of an encoder / decoder

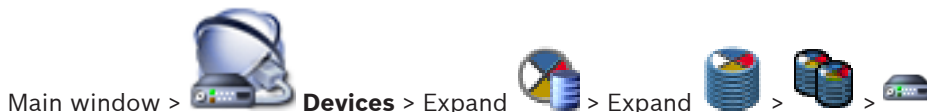



Define and change a separate password for each level. Enter the password (19 characters maximum; no special characters) for the selected level.

To change the password:

1. Right-click  and click **Change password...**
The **Enter password** dialog box is displayed.
 2. In the **Enter user name** list, select the desired user for which you want to change the password.
 3. In the **Enter password for user** field, type in the new password.
 4. Click **OK**.
- ✓ The password is changed immediately on the device.

See also

- *Enter password dialog box, page 249*

12.10 Providing the destination password for a decoder



To enable the access of a password protected encoder to a decoder, you must enter the password of the user authorization level of the encoder as the destination password in the decoder.

To provide:

1. In the **Enter user name** list, select destination password.
 2. In the **Enter password for user** field, type in the new password.
 3. Click **OK**.
- ✓ The password is changed immediately on the device.

See also

- *Enter password dialog box, page 249*

12.11 Configuring the storage media of an encoder

Main window >  **Devices** > Expand  > Expand  >  >  > **Advanced Settings** > **Recording Management**

Note: Ensure that the desired cameras of this encoder are added to the Logical Tree. You must configure the storage media of an encoder to use the ANR function.

Note: If you want to configure the storage media of an encoder that has already been added to your system and is recorded via VRM, ensure that secondary recording is stopped:

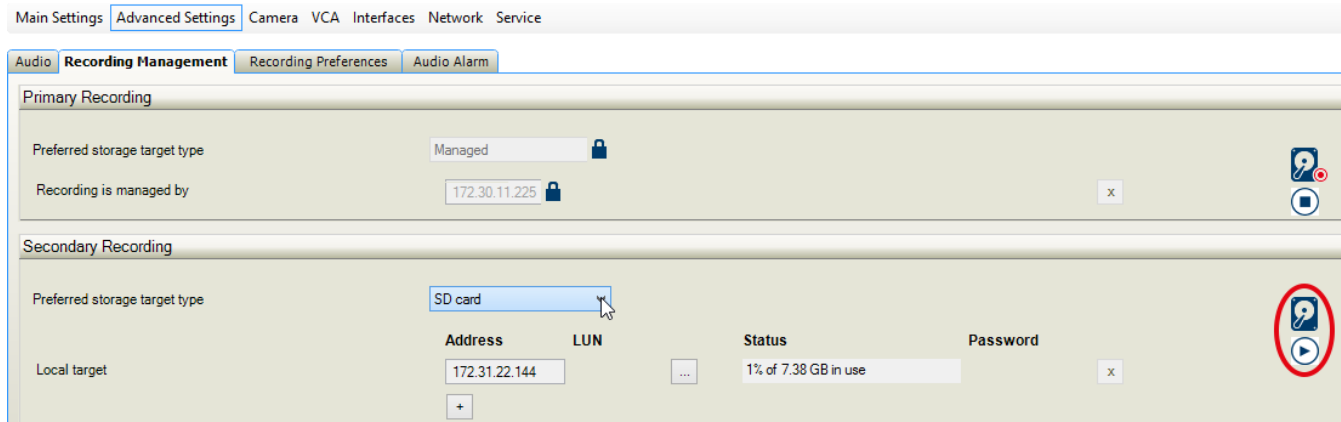

The ANR function only works on encoders with firmware version 5.90 or later. Not all encoder types support ANR even if the correct firmware version is installed.







To configure the storage media of an encoder:

1. Under **Secondary Recording**, in the **Preferred storage target type** list, select the storage media. Depending on the device type, different media are available.
2. If required, click the ... button to format the storage media. After the successful formatting process, the storage media is ready for use with the ANR function.
3. Configure the ANR function for this encoder on the **Cameras and Recording** page.



See also

- *Recording Management page, page 294*
- *Configuring the ANR function, page 194*

12.12 Adding and removing an ONVIF profile

Main window >  **Devices** > Expand  > Expand  > Expand  > Expand  >  > **ONVIF Encoder Events** tab

or

Main window >  **Devices** > Expand  >  > **ONVIF Encoder Events** tab
You can add, remove or change ONVIF profiles for a selected encoder.

To add:

1. Click **Add...**

2. In the **Add Profile** dialog box, type a name for the profile.
3. Click **Next >**.
4. In the next dialog box, select the desired camera.
5. Click **Next >**.
6. In the next dialog box, select the desired non-recording encoder profile.
7. Click **Save**.
 The new profile is saved.
 The settings of this profile are filled with the values from the selected encoder profile.
 You can change these values if required.

To remove:

- ▶ In the list, select a profile and click **Remove**.

To change:

1. In the list, select a profile.
2. Change the settings as required.

12.13 Configuring ONVIF events

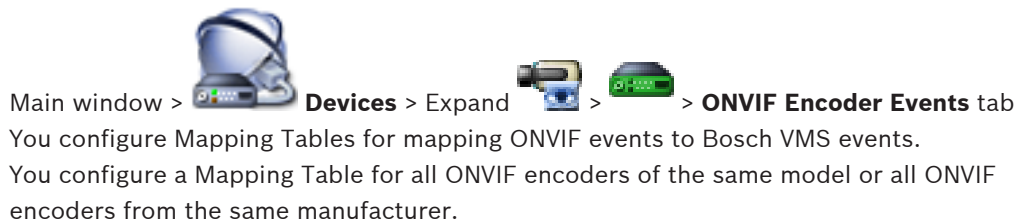
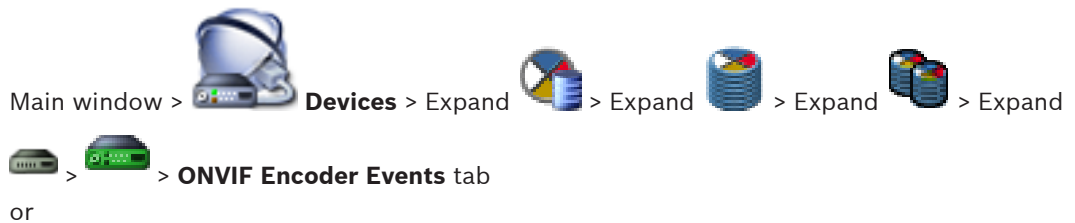

Click  to update ONVIF encoders that were added offline with the event mapping of an already added ONVIF encoder with the same manufacturer and/or model name.
 For multichannel encoders you can configure the event sources, for example a specific camera or a relay.

To create a Mapping Table:

1. Click  .
 The **Add Mapping Table** dialog box is displayed.
2. Type in a name for the Mapping Table.
3. In the **Manufacturer** and the **Model** lists, select the entries if desired.
 When you select **<none>** in both lists, the event mapping is only valid for this device.
 When you select **<none>** in the **Model** list and the manufacturer name in the **Manufacturer** list, the event mapping is valid for all devices with the same manufacturer.
 When you select the available entries in both lists, the event mapping is valid for all devices with the same manufacturer and model.
4. Click **OK**.
 You can now edit the Mapping Table, for example add a row to the **Motion Detected** event.

To edit a Mapping Table:

1. Click .
The **Rename Mapping Table** dialog box is displayed.
2. Change the desired entries.





To add or remove event mappings:

1. In the **Mapping Table** list, select the desired name.
2. To add a row: Click **Add row**.
3. In the row, select the desired entries.
When multiple rows are available, an event is triggered when only one of the rows is true.
4. To remove a row: Click **Remove row**.

To remove a Mapping Table:

1. In the **Mapping Table** list, click the name of the event mappings that you want to remove.
2. Click .





To configure an event source:

1. Expand  and click  or  or .
2. Click the **ONVIF Event Source** tab.
3. In the **Trigger Event** column, activate the event configured in this row.
4. Select the desired event definitions.

See also

- *Enabling logging for ONVIF events, page 394*
- *ONVIF events, page 61*
- *ONVIF Encoder Events page, page 325*
- *ONVIF Event Source page, page 340*

12.14 Importing an ONVIF Mapping Table file

Main window >  **Devices** > Expand  > Expand  > Expand  > Expand  >  > **ONVIF Encoder Events** tab

or

Main window >  **Devices** > Expand  >  > **ONVIF Encoder Events** tab

You can import an ONVIF Mapping Table available as a file (OMF file).

Released ONVIF Mapping files are stored in the following directory of Configuration Client:

- %programdata%\Bosch\VMS\ONVIF

If the same Mapping Table name is already imported, an error message is displayed.

If a newer version of this file is imported, a warning is displayed. Click **OK** if you want to import this file. Otherwise click **Cancel**.

To import:







1. Click .
2. Select the desired file and click **Open**.
The **Import Mapping Table** dialog box is displayed.



3. Make the appropriate settings.
4. Click **OK**.

See also

- *Import Mapping Table dialog box, page 327*
- *ONVIF Encoder Events page, page 325*

12.15 Exporting an ONVIF Mapping Table file

Main window >  **Devices** > Expand  > Expand  > Expand  > Expand
 >  > **ONVIF Encoder Events** tab
 or

Main window >  **Devices** > Expand  >  > **ONVIF Encoder Events** tab
 You can export an ONVIF Mapping Table as a file (OMF file). The Mapping Table is saved for the selected encoder model.

To export:

1. Click .
2. Type in a filename and click **Save**.
 The ONVIF Mapping Table is exported as OMF file for the selected encoder model.

See also

- *ONVIF Encoder Events page, page 325*

12.16 Encrypting live video

Main window >  **Devices** > Expand  > Expand  > Right-click  > Click **Edit Encoder** > **Edit Encoder** dialog box

Main window >  **Devices** > Right-click  > Click **Edit Encoder** > **Edit Encoder** dialog box

Main window >  **Devices** > Right-click  > Click **Edit Encoder** > **Edit Encoder** dialog box

You can activate the encryption of live video transferred from an encoder to the following devices if HTTPS port 443 is configured on the encoder:

- Operator Client computer
- Management Server computer
- Configuration Client computer
- VRM computer
- Decoder

Note:

When activated, the user of Operator Client cannot switch a stream to UDP and to UDP multicast.

When activated, ANR does not work for the affected device.

When activated, encoder replay does not work on encoders with firmware earlier than 6.30.

To activate:

1. Click to enable **Secure connection (encryption)**.
2. Click **OK**.

Encryption is enabled for this encoder.

See also

- *Network Access page, page 315*
- *Edit Encoder / Edit Decoder dialog box, page 247*

12.17**Managing the verification of authenticity**

For activating the verification of authenticity on an encoder, you must perform the following steps:

- Configure the authentication on the encoder.
- Download a certificate from the encoder.
- Install this encoder certificate on the workstation used for authenticity verification.

See also

- *Verification of authenticity, page 69*

12.17.1**Configuring the authentication**

Main window >  **Devices** > Expand  > Expand  > Expand  > 

or

Main window >  **Devices** > Expand  > 

You can activate the verification of authenticity on an encoder.

To configure:

1. Click **Camera**, and then click **Video Input**.
2. In the **Video authentication** list, select **SHA-256**.
3. In the **Signature intervals** list, select the desired value.
A small value increases the security, a large value reduces the load for the encoder.

4. Click .

See also

- *Video Input page, page 295*

12.17.2**Downloading a certificate**

Main window >  **Devices** > Expand  > Expand  > Expand  > 

or

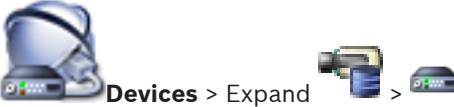
 Main window > **Devices** > Expand
 You can download a certificate from an encoder.

To download:

1. Click **Service**, and then click **Certificates**.
2. Select the desired certificate and click the **Save** icon.

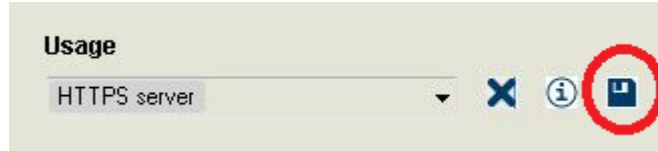

3. Select the appropriate directory for saving the certificate file.
 4. Rename the file extension of the certificate file to *.cer.
- You can now install this certificate on the workstation where you want to verify authenticity.

12.17.3

Installing a certificate on a workstation

You can install the certificate that you have downloaded from an encoder, on a workstation where you want to perform authenticity verification.

1. On the workstation, start `Microsoft Management Console`.
2. Add the `Certificates` snap-in on this computer with the `Computer account` option selected.
3. Expand `Certificates (Local computer)`, expand `Trusted Root Certification Authorities`.
4. Right-click `Certificates`, point to `All Tasks` and then and click `Import...`.
The `Certificate Import Wizard` is displayed.
The `Local Machine` option is preselected and cannot be changed.
5. Click `Next`.
6. Select the certificate file that you have downloaded from the encoder.
7. Click `Next`.
8. Leave the settings unchanged and click `Next`.
9. Leave the settings unchanged and click `Finish`.

13 Managing Video Streaming Gateway





Main window >  **Devices**

This chapter provides information on how to configure the devices in your system.

Changing the Device Tree impacts other pages of the Configuration Client:

- **Maps and Structure**
With the devices of the Device Tree you create a user defined structure called Logical Tree. Hence, if you remove a device from the Device Tree, this device is automatically removed from the Logical Tree. But adding a device to the Device Tree does not add this device to the Logical Tree.
- **Cameras and Recording**
All cameras of the Device Tree are available in the Camera Table and the Recording Tables. You cannot modify DiBos or Bosch Allegiant cameras.
- **Events**
All devices of the Device Tree are available in the corresponding Event Tables.
- **User Groups**
You can reduce the functional range of the devices on several permission pages (per user group or Enterprise Account).

This chapter provides information on how to configure the VSG device in your system.

1. Click  to save the settings.
2. Click  to undo the last setting.
3. Click  to activate the configuration.

See also

- *Video Streaming Gateway device page , page 282*
- *Add Bosch Encoder dialog box, page 283*
- *Add ONVIF Encoder dialog box, page 284*
- *Add JPEG Camera dialog box, page 285*
- *Add RTSP Encoder dialog box, page 286*

13.1 Adding a Video Streaming Gateway device



Main window >  **Devices** > Expand  > 

To add VSG devices via scan:

1. Right-click  and click **Scan for Video Streaming Gateways**.
The **Bosch VMS Scan Wizard** dialog box is displayed.
2. Select the required VSG devices, select the desired VRM pool and click **Assign** to assign them to the VRM pool.
3. Click **Next >>**.
The **Authenticate Devices** dialog box of the wizard is displayed.

- Type in the password for each device that is protected by a password. Password check is performed automatically, when you do not enter a further character in the password field for a few seconds or you click outside the password field. If the passwords of all devices are identical, you can enter it in the first **Password** field. Then right-click this field and click **Copy cell to column**.



In the **Status** column, the successful logons are indicated with



The failed logons are indicated with

- Click **Finish**. The device is added to your Bosch VMS.

To add a VSG device manually:







- Right-click  and click **Add Video Streaming Gateway**. The **Add Video Streaming Gateway** dialog box is displayed.
- Make the required settings for your VSG device.
- Click **Add**.
 - ✓ The VSG device is added to the system. The cameras assigned to this VSG device are recorded.

See also

- *Add Video Streaming Gateway dialog box, page 277*
- *Add Bosch Encoder dialog box, page 283*
- *Add ONVIF Encoder dialog box, page 284*
- *Add JPEG Camera dialog box, page 285*
- *Add RTSP Encoder dialog box, page 286*

13.2 Moving a VSG to another pool



Main window >  **Devices** > Expand  > Expand  > Expand  > 

You move a device from one pool to another within the same VRM device without any recording loss.

To move:

- Right-click  and click **Change Pool ...**. The **Change pool** dialog box is displayed.
- In the **New Pool:** list, select the desired pool.
- Click **OK**. The device is moved to the selected pool.

See also

- *Change Pool for dialog box, page 276*

13.3 Adding a camera to a VSG



Main window >  **Devices** > Expand  > Expand  > Expand  > 

You can add the following devices to your VSG:

- Encoders from Bosch
- ONVIF cameras
- JPEG cameras
- RTSP encoders

If you added VSG encoders offline, you can refresh their state.

To add:

1. Right-click , point to **Add Encoder/camera** and click the desired command.
2. Make the required settings in the dialog box for adding the device.
3. Click **OK**.

The device is added.

To refresh:

- ▶ Right-click the desired encoder and click **Refresh state**.
The properties of the device are retrieved.

See also

- *Add Bosch Encoder dialog box, page 283*
- *Add ONVIF Encoder dialog box, page 284*
- *Add JPEG Camera dialog box, page 285*
- *Add RTSP Encoder dialog box, page 286*

13.4 Configuring multicast

Main window >  **Devices** > Expand  > Expand  > Expand  > 

For each camera assigned to a Video Streaming Gateway device you can configure a multicast address with port.

To configure multicast:

1. Select the desired check box to enable multicast.
2. Type a valid multicast address and a port number.
3. If required, configure continuous multicast streaming.

See also

- *Multicast tab (Video Streaming Gateway), page 282*

13.5 Configuring logging

Main window >  **Devices** > Expand  > Expand  > Expand  > 

For each a Video Streaming Gateway device you can configure logging.

To configure logging:

1. Click the **Service** tab, then click **Advanced**.
2. Click to select the desired logging settings.







The log files are usually stored in the following path:



```
C:\Program Files (x86)\Bosch\Video Streaming Gateway\log
```

See also

- *Advanced tab (Video Streaming Gateway), page 282*

13.6 Adding and removing an ONVIF profile

Main window >  **Devices** > Expand  > Expand  > Expand  > Expand
 >  > **ONVIF Encoder Events** tab
 or

Main window >  **Devices** > Expand  >  > **ONVIF Encoder Events** tab
 You can add, remove or change ONVIF profiles for a selected encoder.

To add:

1. Click **Add...**
 2. In the **Add Profile** dialog box, type a name for the profile.
 3. Click **Next >**.
 4. In the next dialog box, select the desired camera.
 5. Click **Next >**.
 6. In the next dialog box, select the desired non-recording encoder profile.
 7. Click **Save**.
- The new profile is saved.
 The settings of this profile are filled with the values from the selected encoder profile.
 You can change these values if required.



To remove:

- ▶ In the list, select a profile and click **Remove**.

To change:

1. In the list, select a profile.
2. Change the settings as required.

13.7 Assigning an ONVIF profile

Main window >  **Cameras and Recording** > 
 You can assign an ONVIF Media Profile token to an ONVIF camera.
 You can assign either for live video or for recording.

To assign a live video token:

- ▶ In the **Live Video - Profile** column, select the desired entry.

To assign a recording token:

- ▶ In the **Recording - Profile** column, select the desired entry.

See also

- *Cameras page, page 350*

13.8 Configuring ONVIF events

Main window >  **Devices** > Expand  > Expand  > Expand  > Expand

 >  > **ONVIF Encoder Events** tab

or

Main window >  **Devices** > Expand  >  > **ONVIF Encoder Events** tab

You configure Mapping Tables for mapping ONVIF events to Bosch VMS events.

You configure a Mapping Table for all ONVIF encoders of the same model or all ONVIF encoders from the same manufacturer.

Click  to update ONVIF encoders that were added offline with the event mapping of an already added ONVIF encoder with the same manufacturer and/or model name.
For multichannel encoders you can configure the event sources, for example a specific camera or a relay.

To create a Mapping Table:

1. Click  .
The **Add Mapping Table** dialog box is displayed.
2. Type in a name for the Mapping Table.
3. In the **Manufacturer** and the **Model** lists, select the entries if desired.
When you select **<none>** in both lists, the event mapping is only valid for this device.
When you select **<none>** in the **Model** list and the manufacturer name in the **Manufacturer** list, the event mapping is valid for all devices with the same manufacturer.
When you select the available entries in both lists, the event mapping is valid for all devices with the same manufacturer and model.
4. Click **OK**.
You can now edit the Mapping Table, for example add a row to the **Motion Detected** event.

To edit a Mapping Table:

1. Click  .
The **Rename Mapping Table** dialog box is displayed.
2. Change the desired entries.





To add or remove event mappings:

1. In the **Mapping Table** list, select the desired name.
2. To add a row: Click **Add row**.
3. In the row, select the desired entries.
When multiple rows are available, an event is triggered when only one of the rows is true.
4. To remove a row: Click **Remove row**.

To remove a Mapping Table:

1. In the **Mapping Table** list, click the name of the event mappings that you want to remove.
2. Click  .







To configure an event source:

1. Expand  and click  or  or .
2. Click the **ONVIF Event Source** tab.
3. In the **Trigger Event** column, activate the event configured in this row.
4. Select the desired event definitions.

See also

- *Enabling logging for ONVIF events, page 394*
- *ONVIF events, page 61*
- *ONVIF Encoder Events page, page 325*
- *ONVIF Event Source page, page 340*

13.9 Importing an ONVIF Mapping Table file

Main window >  **Devices** > Expand  > Expand  > Expand  > Expand  >  > **ONVIF Encoder Events** tab

or

Main window >  **Devices** > Expand  >  > **ONVIF Encoder Events** tab

You can import an ONVIF Mapping Table available as a file (OMF file).

Released ONVIF Mapping files are stored in the following directory of Configuration Client:

- %programdata%\Bosch\VMS\ONVIF

If the same Mapping Table name is already imported, an error message is displayed.

If a newer version of this file is imported, a warning is displayed. Click **OK** if you want to import this file. Otherwise click **Cancel**.







To import:

1. Click .
2. Select the desired file and click **Open**.
The **Import Mapping Table** dialog box is displayed.
3. Make the appropriate settings.
4. Click **OK**.

See also



- *Import Mapping Table dialog box, page 327*
- *ONVIF Encoder Events page, page 325*

13.10 Exporting an ONVIF Mapping Table file

Main window >  **Devices** > Expand  > Expand  > Expand  > Expand  >  > **ONVIF Encoder Events** tab

or



Main window >  **Devices** > Expand  >  > **ONVIF Encoder Events** tab

You can export an ONVIF Mapping Table as a file (OMF file). The Mapping Table is saved for the selected encoder model.

To export:

1. Click .

2. Type in a filename and click **Save**.

The ONVIF Mapping Table is exported as OMF file for the selected encoder model.

See also

- *ONVIF Encoder Events page, page 325*

14 Managing various devices





Main window > **Devices**

This chapter provides information on how to configure the devices in your system.

Changing the Device Tree impacts other pages of the Configuration Client:

- **Maps and Structure**
With the devices of the Device Tree you create a user defined structure called Logical Tree. Hence, if you remove a device from the Device Tree, this device is automatically removed from the Logical Tree. But adding a device to the Device Tree does not add this device to the Logical Tree.
- **Cameras and Recording**
All cameras of the Device Tree are available in the Camera Table and the Recording Tables. You cannot modify DiBos or Bosch Allegiant cameras.
- **Events**
All devices of the Device Tree are available in the corresponding Event Tables.
- **User Groups**
You can reduce the functional range of the devices on several permission pages (per user group or Enterprise Account).

1. Click  to save the settings.
2. Click  to undo the last setting.
3. Click  to activate the configuration.

14.1 Adding a device manually



Main window > **Devices**

You add the following devices to the Device Tree manually, that means you must know the network address of the device to add it:

- Video IP device from Bosch
- Bosch Recording Station/DiBos system
- Analog matrix
For adding a Bosch Allegiant device, you need a valid Allegiant configuration file.
- Bosch VMS workstation
A workstation must have the Operator Client software installed.
- Communication device
- Bosch ATM/POS Bridge, DTP device
- Virtual input
- Network monitoring device
- Bosch IntuiKey keyboard
- KBD-Universal XF keyboard
- Analog monitor group
- I/O module
- Allegiant CCL emulation
- Intrusion panel from Bosch

- Server-based analytics device

You can scan for the following devices to add them with the help of the **Bosch VMS Scan Wizard** dialog box:

- VRM devices
- Encoders
- Live only encoders
- Live only ONVIF encoders
- Local storage encoders
- Decoders
- Video Streaming Gateway (VSG) devices
- DVR devices
- VIDOS NVRs





Notice:

After having added a device, click  to save the settings.

Notice:

If you add a Video IP encoder or decoder from Bosch with the **<Auto Detect>** selection, this device must be available in the network.

To add a Video IP device from Bosch:

1. Expand , expand , right-click .
Or
Right-click .
Or
Right-click .
2. Click **Add Encoder**.
The **Add Encoder** dialog box is displayed.
3. Enter the appropriate IP address.
4. In the list, select **<Auto Detect>**.
5. Click **OK**.
The device is added to the system.

To add a DiBos system:

1. Right-click .
2. Click **Add BRS/DiBos System**.
The **Add BRS/DiBos System** dialog box is displayed.
3. Enter the appropriate values.
4. Click **Scan**.
The DiBos system is added to your system.
5. In the displayed message box, click **OK** to confirm.



Caution!

Add the DVR using the administrator account of the device. Using a DVR user account with restricted permissions can result in features that are not usable in Bosch VMS, for example using the control of a PTZ camera.

To add a Bosch Allegiant device:

1. Right-click  and click **Add Allegiant**.
The **Open** dialog box is displayed.
2. Select the appropriate Allegiant configuration file and click **OK**.
The Bosch Allegiant device is added to your system.



Note: You can add only one Bosch Allegiant matrix.

To add a Bosch VMS workstation:



1. Right-click  and click **Add Workstation**.
The **Add Workstation** dialog box is displayed.
2. Enter the appropriate value click **OK**.

The workstation  is added to your system.



To add an analog monitor group:

1. Expand , right-click  and click **Add Monitor Group**.
The **Create New Analog Monitor Group** dialog box is displayed.
If you already have performed a network scan, and decoders have been detected, there is already a default analog monitor group available with all detected decoders assigned.
2. Make the appropriate settings.
3. Click **OK**.
The analog monitor group is added to your system.



To add a communication device:

1. Expand , right-click  and click the required command.
The appropriate dialog box is displayed.
2. Enter the appropriate settings.
3. Click **OK**.
The communication device is added to your system.



To add a peripheral device:

1. Expand , right-click  and click the required command.
The appropriate dialog box is displayed.
2. Enter the appropriate settings.
3. Click **OK**.
The peripheral device is added to your system.

To add a virtual input:



1. Expand , click .
The corresponding page is displayed.
2. Click **Add Inputs**.
A row is added to the table.
3. Make the appropriate settings.
4. Click **Add**.
The virtual input is added to your system.

To add a network monitoring device:



1. Expand , right-click  and click **Add SNMP**.
The **Add SNMP** dialog box is displayed.
2. Type a name for the SNMP device.
The network monitoring device is added to your system.

To add a CCTV keyboard:

Note: For adding a keyboard you must have added a workstation.

1. Expand , click .
The corresponding page is displayed.
2. Click **Add Keyboard**.
A row is added to the table.
3. In the appropriate field of the **Keyboard Type** column, select the desired keyboard type:
IntuiKey Keyboard
KBD-Universal XF Keyboard
4. In the appropriate field of the **Connection** column, select the workstation that is connected with the keyboard.
5. Make the appropriate settings.
The keyboard is added to your system.



To add an I/O module:

1. Expand , right-click  and click **Add New ADAM Device**.
The **Add ADAM** dialog box is displayed.
2. Type the IP address of the device.
If you want to skip the currently selected device and jump to the next one, click **Skip**.
3. Select the device type.
The corresponding page is displayed.
4. Click the **ADAM** tab to change the display names of the inputs if required.
5. Click the **Name** tab to change the display names of the Relays if required.

**Notice!**

You can also perform a scan for ADAM devices (**Scan for ADAM Devices**). The IP addresses of the devices are detected. If available the device type is preselected. You must confirm this selection.

To add an Allegiant CCL emulation:



1. Expand , click .
The **Allegiant CCL Emulation** tab is displayed.
2. Click to check **Enable Allegiant CCL Emulation**.
3. Make the required settings.
The Allegiant CCL emulation service is started on the Management Server.

To add an intrusion panel:

1. Expand , right-click  and click **Add Panel**.
The **Add Intrusion Panel** dialog box is displayed.
2. Enter the appropriate values.

3. Click **OK**.
The intrusion panel is added to your system.



To add a server-based analytics device:

1. Expand , right-click  and click **Add Video Analytics Device**.
The **Add Video Analytics Device** dialog box is displayed.
2. Enter the appropriate values.
3. Click **OK**.
The device is added to your system.

See also

- *Add Encoder / Add Decoder dialog box, page 246*
- *Add DiBos System dialog box, page 239*
- *E-mail/SMTP Server dialog box, page 254*
- *Add SMS Device dialog box, page 254*
- *Add Bosch ATM/POS-Bridge dialog box, page 257*
- *DTP Settings page, page 258*
- *Add Virtual Inputs dialog box, page 260*
- *Add SNMP dialog box, page 261*
- *Assign Keyboard page, page 262*
- *I/O Modules page, page 263*
- *Allegiant CCL Emulation page, page 264*
- *Add Intrusion Panel dialog box, page 266*

14.2 Adding a VIDOS NVR

Main window >  **Devices** > Expand  > 

The system supports you with a scan for devices.

To add VIDOS NVRs via scan:

1. Right-click  and click **Start Vidos NVR Scan**.
The **Bosch VMS Scan Wizard** dialog box is displayed.
2. Select the desired check boxes for the devices that you want to add.
3. Click **Next >>**.
The **Authenticate Devices** dialog box of the wizard is displayed.
4. Type in the password for each device that is protected by a password.
Password check is performed automatically, when you do not enter a further character in the password field for a few seconds or you click outside the password field.
If the passwords of all devices are identical, you can enter it in the first **Password** field.
Then right-click this field and click **Copy cell to column**.

In the **Status** column, the successful logons are indicated with .

The failed logons are indicated with .

5. Click **Finish**.
The device is added to your Bosch VMS.

See also

- *Bosch VMS Scan Wizard, page 267*

14.3 Configuring a decoder for use with a Bosch IntuiKey keyboard



Main window > **Devices** > Expand

Perform the following steps to configure a VIP XD decoder that is connected to a Bosch IntuiKey keyboard.

To configure a decoder:

1. Click the appropriate decoder which is used for connecting a Bosch IntuiKey keyboard.
2. Click the **Periphery** tab.
3. Ensure that the following settings are applied:
 - Serial port function: **Transparent**
 - Baud rate: **19200**
 - Stop bits: **1**
 - Parity check: **None**
 - Interface mode: **RS232**
 - Half-duplex mode: **Off**

See also

- *Scenarios for Bosch IntuiKey keyboard connections, page 73*
- *Connecting a Bosch IntuiKey keyboard to a decoder, page 74*
- *Updating Bosch IntuiKey keyboard firmware, page 75*
- *COM1, page 311*

14.4 Configuring the integration of a DiBos system



Main window > **Devices** > Expand

**Notice!**

You do not configure the DiBos system itself but only the integration into Bosch VMS.

To scan for new DiBos devices:

- ▶ Right-click  and click **Rescan BRS/DiBos System**.
The DiBos system is scanned for new devices and they are added.

To remove an item:

1. Click the **Cameras** tab, the **Relays** tab, or the **Inputs** tab.
2. Right-click an item and click **Remove**. The item is removed.

To rename a DiBos device:

1. Right-click a DiBos device and click **Rename**.
2. Type the new name for the item.

14.5 Configuring the integration of a DVR



Main window >  **Devices** > Expand  > 



Caution!

Add the DVR using the administrator account of the device. Using a DVR user account with restricted permissions can result in features that are not usable in Bosch VMS, for example using the control of a PTZ camera.



Notice!

You do not configure the DVR itself but only the integration of the DVR device into Bosch VMS.

To add DVR devices via scan:

1. Right-click  and click **Scan for DVR Devices**.
The **Bosch VMS Scan Wizard** dialog box is displayed.
2. Select the desired check boxes for the devices that you want to add.
3. Click **Next >>**.
The **Authenticate Devices** dialog box of the wizard is displayed.
4. Type in the password for each device that is protected by a password.
Password check is performed automatically, when you do not enter a further character in the password field for a few seconds or you click outside the password field.
If the passwords of all devices are identical, you can enter it in the first **Password** field.
Then right-click this field and click **Copy cell to column**.

In the **Status** column, the successful logons are indicated with .

The failed logons are indicated with .

5. Click **Finish**.
The device is added to your Bosch VMS.

To remove an item:

1. Click the **Settings** tab, the **Cameras** tab, the **Inputs** tab, or the **Relays** tab.
2. Right-click an item and click **Remove**. The item is removed.



Notice!

To restore a removed item, right-click the DVR device and click **Rescan DVR Device**.

To rename a DVR device:



1. Right-click a DVR device and click **Rename**.
2. Type the new name for the item.

See also

- *Bosch VMS Scan Wizard, page 267*
- *DVR (Digital Video Recorder) page, page 240*

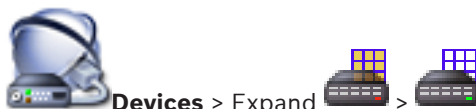
14.6 Configuring a Bosch Allegiant device



Main window >  **Devices** > Expand  > 

You do not configure the Bosch Allegiant device itself but only the Bosch VMS related properties.

To assign an output to an encoder:

1. Click the **Outputs** tab.
2. In the **Usage** column, click **Digital Trunk** in the desired cells.
3. In the **Encoder** column, select the desired encoder.

Adding an input to a Bosch Allegiant device:

1. Click the **Inputs** tab.
2. Click **Add Inputs**. A new row is added to table.
3. Type the required settings in the cells.

Deleting an input:



1. Click the **Inputs** tab.
2. Click the required table row.
3. Click **Delete Input**. The row is deleted from the table.

See also

- *Connecting a Bosch IntuiKey keyboard to Bosch VMS, page 73*
- *Connection page, page 241*
- *Cameras page, page 242*
- *Outputs page, page 242*
- *Inputs page, page 243*

14.7 Configuring a startup Command Script



Main window >  **Devices** > Expand  >  > **Settings** page

You configure a Command Script to be started when the Operator Client on the selected workstation is started.

You must create a corresponding Command Script.

For creating a Command Script, see *Managing Command Scripts, page 205*.

To configure a startup script:

- ▶ In the **Startup script:** list, select the required Command Script.

See also

- *Workstation page, page 243*

14.8 Changing the network address of a workstation



Main window >  **Devices** > Expand 



To change the IP address:

1. Right-click  and click **Change Network Address**.
The **Change Network Address** dialog box is displayed.

2. Change the entry in the field according to your requirements.

14.9 Enabling Forensic Search on a workstation



Main window >  **Devices** > Expand  >  > **Settings** page

You must enable Forensic Search on a workstation.

Note:

Enable video content analysis on each encoder. Use the VCA page of the encoder in the Device Tree.

To enable Forensic Search:

- ▶ Click to select the **Enable Forensic Search** check box.

14.10 Assigning an analog monitor group to a workstation



Main window >  **Devices** > Expand  >  > **Analog Monitor Groups** page

You assign an analog monitor group to a Bosch VMS workstation. In the **Options** dialog box, you can configure that all workstations can control analog monitor groups regardless of the setting here.

To assign an analog monitor group:

- ▶ In the **Assigned Analog Monitor Groups** column, select the check box.

See also

- *Options dialog box, page 229*
- *Workstation page, page 243*

14.11 Configuring an analog monitor group



Main window >  **Devices** > Expand  > 

Caution!

You cannot control an analog monitor group from within Operator Client when the connection to the Management Server is lost or when Operator Client with Enterprise System is used.

You configure the monitors in an analog monitor group logically in rows and columns. This arrangement does not have to meet the physical arrangement of the monitors.

To configure an analog monitor group:

1. In the **Name:** field, type a name for the analog monitor group.
2. In the **Columns:** and **Rows:** fields, enter the desired values.
3. Drag each available decoder to an analog monitor image on the right.
The logical number of the decoder is displayed as a black number on the monitor image and the color of this image changes.
If no decoder is available, unassign a decoder from another analog monitor group or repeat network scan.
4. Click the **Advanced Configuration** tab.
5. Change the logical numbers of the assigned decoders as required. If you enter an already used number, a message box is displayed.

- Click **Quad View** to enable quad view for this decoder.

Note:

We do not recommend configuring quad view for H.264 cameras.

- In the **Initial Camera** column, select the desired camera.
- In the OSD related columns, select the desired options.

14.12 Adding a monitor wall

Main window >  **Devices** > Right-click  > Click **Add Monitor Wall**

After having added the monitor wall, the user of Operator Client can control this monitor wall. The user can change the monitor layout and assign encoders to monitors.

To add:

- Select the desired decoder.
- If required, enter the maximum number of cameras and configure thumbnails.

- Click .

- Click  **Maps and Structure**.
- Drag the monitor wall to the Logical Tree.
- If required, configure the access to the monitor wall with corresponding user group permissions.



See also

- *Add Monitor Wall dialog box, page 253*

14.13 Configuring a communication device

Main window >  **Devices** > Expand  > Expand 

To configure a communication device:





- Click the required device:  or .
- Make the appropriate settings.

For detailed information on the various fields, see the Online Help for the appropriate application window.

See also

- *E-mail/SMTP Server dialog box, page 254*
- *Add SMS Device dialog box, page 254*
- *SMTP Server page, page 254*
- *GSM Settings / SMSC Settings page, page 256*

14.14 Configuring a peripheral device

Main window >  **Devices** > Expand  > Expand  >  **Bosch ATM/POS-Bridge**

or



To configure a peripheral device:

- ▶ Change the required settings.

For detailed information on the various fields, follow the link to the appropriate application window below.

See also

- *ATM Settings page, page 258*
- *Bosch ATM/POS-Bridge page, page 257*
- *DTP Settings page, page 258*

14.15 Configuring an SNMP trap receiver



To configure the SNMP trap receiver:

1. Click  to display the **SNMP Trap Receiver** page.
2. Make the required settings.

For detailed information on the various fields, see the Online Help for the appropriate application window.

See also

- *SNMP Trap Receiver page, page 261*

14.16 Configuring a Bosch IntuiKey keyboard (workstation)



To configure a Bosch IntuiKey keyboard connected to a workstation:

1. Click the **Settings** tab.
2. In the **Keyboard Settings** field, make the required settings.

For detailed information on the various fields, see the Online Help for the appropriate application window.

See also

- *Workstation page, page 243*

14.17 Configuring a Bosch IntuiKey keyboard (decoder)



**Notice!**

You cannot connect a KBD-Universal XF keyboard to a decoder.

To configure a Bosch IntuiKey keyboard connected to a decoder:

1. In the **Connection** column, click a cell, and select the appropriate decoder.
You can also select a workstation, if the Bosch IntuiKey keyboard is connected to it.

A workstation must be configured on the  page.

2. In the **Connection Settings** field, make the required settings.
For detailed information on the various fields, see the Online Help for the appropriate application window.

See also

- *Assign Keyboard page, page 262*
- *Scenarios for Bosch IntuiKey keyboard connections, page 73*
- *Connecting a Bosch IntuiKey keyboard to a decoder, page 74*

14.18 Configuring an I/O module

Main window >  **Devices** > Expand  > Expand  > 

To configure an I/O module:

1. Click the **ADAM** tab.
2. In the **ADAM type:** list, select the appropriate device type.

Caution!

Do not change the device type if not really necessary.

If you for example change the device type to a type with fewer inputs, all configuration data for the removed inputs get lost.

1. Click the **Inputs** tab.
2. In the **Name** column, change the display name of an input if required.
3. Click the **Relays** tab.
4. In the **Relays** column, change the name of a relay if required.

For detailed information on the various fields, see the Online Help for the appropriate application window.

See also

- *I/O Modules page, page 263*

14.19 Configuring an Allegiant CCL emulation

Main window >  **Devices** > Expand  > 

To use the CCL commands you need the CCL User Guide. This manual is available in the Online Product Catalog in the document section of each LTC Allegiant Matrix.

The *Allegiant CCL commands supported in Bosch VMS, page 80* section lists the CCL commands supported in Bosch Video Management System.

To configure an Allegiant CCL emulation:

1. Click **Enable Allegiant CCL Emulation**.
2. Configure the communication settings as required.

For detailed information on the various fields, see the Online Help for the appropriate application window.

See also

- *Allegiant CCL Emulation page, page 264*

14.20 Adding a Mobile Video Service



Main window > **Devices** > Right-click > Click **Add Mobile Video Service**

You can add one or more Mobile Video Service entries to your Bosch VMS.

To add:

1. Type in the URI of your Mobile Video Service.
 2. Click **OK**.
- ✓ Mobile Video Service and Management Server now know each other and the Mobile Video Service can receive configuration data from Management Server.

See also

- *Mobile Video Service page, page 265*

14.21 Adding a video analytics device



Main window > **Devices** > Expand >

When adding a server-based analytics device, you type in the credentials for the new device.

To add:

1. Right-click  and click **Add Video Analytics Device**.
The **Add Video Analytics Device** dialog box is displayed.
2. Type in the required information.

For detailed information on the various fields, see the Online Help for the appropriate application window.

See also

- *Add Video Analytics Device dialog box, page 267*
- *Configuring server-based video analytics, page 173*

15 Configuring video-based fire alarm detection

For configuring a video-based fire alarm you must perform the following steps:

1. Configure a fire detection on your fire detection camera.
You use the Webpage of the camera for this configuration.
For detailed information on configuring a fire detection camera, see
 - *Configuring a fire detection camera, page 168*
2. Add this fire detection camera to the system. You can add the fire detection camera to a VRM pool, as a live only encoder, or as a local storage encoder.
For detailed information on adding a camera, see
 - *Adding an encoder to a VRM pool, page 169*
 - *Adding a live only encoder, page 169*
 - *Adding a local storage encoder, page 170*
3. Configure a fire event for this camera.
 - *Configuring a fire event, page 171*
4. Configure the alarm for the fire event.
 - *Configuring a fire alarm, page 171*

See also

- *Adding an encoder to a VRM pool, page 169*
- *Adding a live only encoder, page 169*
- *Adding a local storage encoder, page 170*
- *Configuring a fire event, page 171*
- *Configuring a fire alarm, page 171*

15.1 Configuring a fire detection camera

Main window >  **Devices** > Expand  > Expand  > Expand  > 

or

Main window >  **Devices** > Expand  > Expand  > Expand  > 

or

Main window >  **Devices** >  > 

or

Main window >  **Devices** >  > 





For configuring a video-based fire alarm, you must first configure the fire detection on the fire detection camera.

For details see the Operation Manual of your fire detection camera.

To configure:

1. Right-click the device icon and click **Show Webpage in Browser**.
2. Click **Configuration**.
3. On the navigation pane, expand **Alarm** and click **Fire detection**.
4. Perform the desired settings.

15.2 Adding an encoder to a VRM pool

Main window >  **Devices** > Expand  > Expand  > 

The system supports you with a scan for devices.

To add encoders via scan:

1. Right-click  and click **Scan for Encoders**.
The **Bosch VMS Scan Wizard** dialog box is displayed.
2. Select the required encoders, select the desired VRM pool and click **Assign** to assign them to the VRM pool.
3. Click **Next >>**.
The **Authenticate Devices** dialog box of the wizard is displayed.
4. Type in the password for each device that is protected by a password.
Password check is performed automatically, when you do not enter a further character in the password field for a few seconds or you click outside the password field.
If the passwords of all devices are identical, you can enter it in the first **Password** field.
Then right-click this field and click **Copy cell to column**.

In the **Status** column, the successful logons are indicated with .

The failed logons are indicated with .

5. Click **Finish**.
The device is added to your Bosch VMS.

See also

- *Bosch VMS Scan Wizard, page 267*

15.3 Adding a live only encoder

Main window >  **Devices** > 

The system supports you with a scan for devices.

To add Bosch live only devices via scan:

1. Right-click  and click **Scan for Live Only Encoders**.
The **Bosch VMS Scan Wizard** dialog box is displayed.
2. Select the desired check boxes for the devices that you want to add.
3. Click **Next >>**.
The **Authenticate Devices** dialog box of the wizard is displayed.
4. Type in the password for each device that is protected by a password.
Password check is performed automatically, when you do not enter a further character in the password field for a few seconds or you click outside the password field.
If the passwords of all devices are identical, you can enter it in the first **Password** field.

Then right-click this field and click **Copy cell to column**.



In the **Status** column, the successful logons are indicated with



The failed logons are indicated with

5. Click **Finish**.

The device is added to your Bosch VMS.

To add ONVIF live only devices via scan:

1. Right-click  and click **Scan for Live Only ONVIF Encoders**.
The **Bosch VMS Scan Wizard** dialog box is displayed.
2. Select the desired check boxes for the devices that you want to add.
3. Click **Next >>**.
The **Authenticate Devices** dialog box of the wizard is displayed.
4. Type in the password for each device that is protected by a password.
Password check is performed automatically, when you do not enter a further character in the password field for a few seconds or you click outside the password field.
If the passwords of all devices are identical, you can enter it in the first **Password** field.
Then right-click this field and click **Copy cell to column**.



In the **Status** column, the successful logons are indicated with



The failed logons are indicated with

5. Click **Finish**.

The device is added to your Bosch VMS.

See also

- *Bosch VMS Scan Wizard*, page 267
- *Live Only page*, page 286

15.4 Adding a local storage encoder

Main window >  **Devices** > 

The system supports you with a scan for devices.

To add local storage encoders via scan:

1. Right-click  and click **Scan for Local Storage Encoders**.
The **Bosch VMS Scan Wizard** dialog box is displayed.
2. Select the desired check boxes for the devices that you want to add.
3. Click **Next >>**.
The **Authenticate Devices** dialog box of the wizard is displayed.
4. Type in the password for each device that is protected by a password.
Password check is performed automatically, when you do not enter a further character in the password field for a few seconds or you click outside the password field.
If the passwords of all devices are identical, you can enter it in the first **Password** field.

Then right-click this field and click **Copy cell to column**.



In the **Status** column, the successful logons are indicated with



The failed logons are indicated with

5. Click **Finish**.

The device is added to your Bosch VMS.

See also

- *Bosch VMS Scan Wizard, page 267*
- *Local Storage page, page 287*

15.5 Configuring a fire event



Main window > **Events**

To configure:

1. In the tree, select **Encoders/Decoders > Camera > Fire or Smoke State > Fire or Smoke detected**.
The corresponding Event Configuration Table is displayed.
2. In the **Trigger Alarm - Schedule** column, click a cell and select the appropriate schedule.
The schedule determines when the alarm is triggered.
Select one of the Recording Schedules or Task Schedules that you have configured in the **Schedules** page.
3. Make the required settings.

Note: You can use the same procedure for the other available fire events.

15.6 Configuring a fire alarm



Main window > **Alarms**

To configure:

1. In the tree, select **Encoders/Decoders > Camera > Fire or Smoke State > Fire or Smoke detected**.
The corresponding Alarm Configuration Table is displayed.
2. Make the required settings.

16

Configuring MIC IP 7000 connected to a VIDEOJET 7000 connect

For operating a MIC IP 7000 camera connected to a VIDEOJET 7000 connect, you must perform the following configuration for proper working.

Before you add the MIC IP camera to Bosch VMS, perform the following tasks:

1. Reset both the MIC IP 7000 camera and the VIDEOJET 7000 connect device to the factory default settings on the Web page of each device.
2. Set the MIC IP 7000 camera to the **MIC IP Starlight 7000 HD-VJC-7000** variant.
3. Configure the MIC IP 7000 camera and the VIDEOJET 7000 connect device according to the documentation delivered with the devices.
4. If you want to use ANR, execute the ANR Setup Utility for the VIDEOJET 7000 connect device.

Perform this task on a computer being member of the same network as the VIDEOJET 7000 connect device.

You find the ANR Setup Utility on the product catalog page for the VIDEOJET 7000 connect device.



Perform this procedure to add and configure the MIC IP 7000 camera in Bosch VMS:

1. In the Device Tree, add only the MIC IP 7000 camera.
You cannot add the VIDEOJET 7000 connect device to Bosch VMS.
2. Right-click the just added camera and click **Edit Encoder**.
The **Edit Encoder** dialog box is displayed.
The device capabilities are automatically retrieved according to the variant configured above.
3. If required, configure ANR on the **Cameras and Recording** page.

17

Configuring server-based video analytics

Perform the following steps to configure video analytics:

1. Install the analytics viewer application of the video analytics on each Bosch VMS workstation to be used for analytics. Take a note containing the path to the analytics viewer application.
For detailed information on installing the analytics viewer application, see: *Installing the analytics viewer application, page 173*.
2. Add the cameras to the Device Tree that you want to use as analytics cameras. These cameras are automatically retrieved when the Bintelan Analytics Platform connects with your Bosch VMS Management Server.
3. Add a video analytics device  to the Device Tree of Configuration Client.
For detailed information on adding a video analytics device, see: *Adding a video analytics device, page 174*.
4. In the video analytics device, configure the path to the analytics viewer application. A default path of the analytics viewer application is pre-configured.
5. Configure the IP address of the Bintelan Analytics Platform.
6. Use the Bintelan Bosch Client application on the Bintelan Analytics Platform for connecting with Bosch VMS Management Server.
Type in the IP address of this Management Server.
7. Add the video analytics device  to the Logical Tree.
8. Configure an alarm for the **External Data** event for the desired video analytics cameras.
9. The user of Operator Client drags the video analytics device to an Image pane.
10. When an alarm occurs, an external data alarm entry is displayed in the Alarm List.
11. The user selects this entry in the Alarm List.
An image with the matched person or object is displayed in the analytics viewer application.

See also

- *Adding a video analytics device, page 174*
- *Video Analytics Settings page, page 266*
- *Installing the analytics viewer application, page 173*

17.1

Installing the analytics viewer application

For displaying the Ganetec analytics viewer application, the software must be installed in the directory configured in Configuration Client.

For installation, you need the BintelanClient_BoschAlarmViewer.exe from the Ganetec Web page or from the Bosch Online Product Catalog.

Perform the installation on each Operator Client workstation where you want to use the analytics viewer application.

To install:

1. Double-click the Setup.
2. Follow the instructions on the screen.

Note: The installation directory for the analytics viewer application must be below
`%ProgramFiles(x86)%\VideoAnalytics.`

17.2 Adding a video analytics device

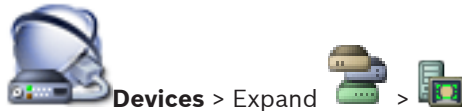

Main window >  **Devices** > Expand  > 

When adding a server-based analytics device, you type in the credentials for the new device.

To add:

1. Right-click  and click **Add Video Analytics Device**.
The **Add Video Analytics Device** dialog box is displayed.
2. Type in the required information.

For detailed information on the various fields, see the Online Help for the appropriate application window.

See also

- *Add Video Analytics Device dialog box, page 267*
- *Configuring server-based video analytics, page 173*

18 Configuring maps and structure

This chapter provides information on how to configure the Logical Tree and how to manage resource files such as maps.





Notice!

If you move a group of devices in the Logical Tree, these devices lose their permission settings. You must set the permissions in the **User Groups** page again.

Follow these references to get detailed information on the available application windows:

- *Resource Manager dialog box, page 343*
- *Select Resource dialog box, page 343*
- *Sequence Builder dialog box, page 344*
- *Add Sequence dialog box, page 345*
- *Add Sequence Step dialog box, page 345*
- *Add URL dialog box, page 345*
- *Select Map for Link dialog box, page 346*

1. Click  to save the settings.
2. Click  to undo the last setting.
3. Click  to activate the configuration.

18.1 Configuring the Logical Tree

See also

- *Maps and Structure page, page 342*

18.2 Adding a device to the Logical Tree



Main window > **Maps and Structure**

To add a device:

- ▶ Drag an item from the Device Tree to the required location in the Logical Tree. You can drag a complete node with all sub-items from the Device Tree to the Logical Tree. You can select multiple devices by pressing the CTRL- or the SHIFT-key.

See also

- *Maps and Structure page, page 342*

18.3 Removing a tree item



Main window > **Maps and Structure**

To remove a tree item from the Logical Tree:

- ▶ Right-click an item in the Logical Tree and click **Remove**. If the selected item has sub-items, a message box is displayed. Click **OK** to confirm. The item is removed.
When you remove an item from a map folder of the Logical Tree, it is also removed from the map.

See also

- *Maps and Structure page, page 342*

18.4 Managing resource files

Main window >  **Maps and Structure** > 
or

Main window >  **Alarms** > 

You can import resource files in the following formats:

- DWF files (2 D, map resource files)
For use in Operator Client, these files are converted to a bitmap format.
- HTML files (map document files)
- MP3 (audio file)
- TXT files (Command Scripts or camera sequences)
- MHT files (Web archives)
- URL files (links to Web pages)
- WAV (audio file)

The imported resource files are added to a database. They are not linked to the original files.

**Notice!**

After each of the following tasks:

Click  to save the settings.

To import a resource file:

1. Click  .
The **Import Resource** dialog box is displayed.
2. Select one or more files.
3. Click **Open**.
The selected files are added to the list.
If a file has already been imported, a message box is displayed.
If you decide to import an already imported file again, a new entry is added to the list.

To remove a resource file:

1. Select a resource file.
2. Click  .
The selected resource file is removed from the list.

To rename a resource file:

1. Select a resource file.

2. Click .
3. Enter the new name.
The original file name and creation date persists.

To replace the content of a resource file:

1. Select a resource file.
2. Click .
3. Select a file with the appropriate content and click **Open**.
The resource name persists, the original file name is exchanged with the new file name.

To export a resource file:

1. Select a resource file.
2. Click .
3. Select the appropriate directory and click **OK**.
The original file is exported.

See also

- *Select Resource dialog box, page 343*

18.5 Adding a Command Script



Main window > **Maps and Structure**

Before you can add a Command Script, you must have Command Script files imported or created.

If required, see *Configuring Command Scripts, page 205* for details.

To add a Command Script file:

1. Select a folder where you want to add the new Command Script.
2. Click . The **Select Client Script** dialog box is displayed.
3. Select a file in the list.
4. Click **OK**.
A new Command Script is added under the selected folder.

See also

- *Select Resource dialog box, page 343*

18.6 Managing pre-configured camera sequences



Main window > **Maps and Structure**

You can perform the following tasks for managing camera sequences:

- Create a camera sequence
- Add a step with a new dwell time to an existing camera sequence
- Remove a step from camera sequence
- Delete a camera sequence

**Notice!**

When the configuration is changed and activated, a camera sequence (pre-configured or automatic) usually is continued after restart of the Operator Client.

But in the following cases the sequence is not continued:

A monitor where the sequence is configured to be displayed has been removed.

The mode of a monitor (single/quad view) where the sequence is configured to be displayed has been changed.

The logical number of a monitor where the sequence is configured to be displayed is changed.

**Notice!**

After each of the following tasks:

Click to save the settings.

To create a camera sequence:

1. In the Logical Tree, select a folder where you want to create the camera sequence.

2. Click .

The **Sequence Builder** dialog box is displayed.

3. In the **Sequence Builder** dialog box, click .

The **Add Sequence** dialog box is displayed.

4. Enter the appropriate values.

For detailed information on the various fields, see the Online Help for the appropriate application window.

▶ Click **OK**.

A new camera sequence is added.

To add a step with a new dwell time to a camera sequence:

1. Select the desired camera sequence.

2. Click **Add Step**.

The **Add Sequence Step** dialog box is displayed.

3. Make the appropriate settings.

4. Click **OK**.

A new step is added to the camera sequence.

To remove a step from a camera sequence:

▶ Right-click the desired camera sequence and click **Remove Step**.

The step with the highest number is removed.

To delete a camera sequence:

1. Select the desired camera sequence.

2. Click . The selected camera sequence is removed.

See also

- *Sequence Builder dialog box, page 344*
- *Add Sequence dialog box, page 345*
- *Add Sequence Step dialog box, page 345*

18.7 Adding a camera sequence



Main window > **Maps and Structure**

You add a camera sequence to the root directory or to a folder of the Logical Tree.

To add a camera sequence:

1. In the Logical Tree, select a folder where you want to add the new camera sequence.



2. Click . The **Sequence Builder** dialog box is displayed.

3. In the list, select a camera sequence.

4. Click **Add to Logical Tree**. A new  is added under the selected folder.

See also

- *Sequence Builder dialog box, page 344*

18.8 Adding a folder



Main window > **Maps and Structure**

To add a folder:

1. Select a folder where you want to add the new folder.



2. Click . A new folder is added under the selected folder.



3. Click  to rename the folder.

4. Type the new name and press ENTER.

See also

- *Maps and Structure page, page 342*

18.9 Adding a map



Main window > **Maps and Structure**

Before you can add a map, you must have map resource files imported.

To import a map resource file see *Managing resource files, page 176* for details.

To add a map:

1. Ensure that the map resource file that you want to add has already been imported.
2. Select a folder where you want to add the new map.



3. Click . The **Select Resource** dialog box is displayed.

4. Select a file in the list.

If the required files are not available in the list, click **Manage...** to display the **Resource Manager** dialog box for importing files.

5. Click **OK**.

A new map  is added under the selected folder.
The map is displayed.
All devices within this folder are displayed in the upper left corner of the map.

See also

- *Select Resource dialog box, page 343*



18.10 Adding a link to another map



Main window > **Maps and Structure**

After you have added at least two maps, you can add a link on one map to the other so that the user can click from one map to a linked one.

To add a link:

1. Click a map folder  in the Logical Tree.
2. Right-click the map and click **Create Link**.
The **Select Map for Link** dialog box is displayed.
3. In the dialog box, click a map .
4. Click **Select**.
5. Drag the item to the appropriate place on the map.

See also

- *Select Map for Link dialog box, page 346*

18.11 Assigning a map to a folder



Main window > **Maps and Structure**

Before you can assign maps, you must have map resource files imported.
If required, see *Managing resource files, page 176* for details.

To assign a map resource file:

1. Right-click a folder and click **Assign Map**.
The **Select Resource** dialog box is displayed.
2. Select a map resource file in the list.
3. Click **OK**. The selected folder is displayed as .
The map is displayed in the map window.
All items within this folder are displayed in the upper left corner of the map.

See also

- *Maps and Structure page, page 342*
- *Select Resource dialog box, page 343*

18.12 Managing devices on a map



Main window > **Maps and Structure**

Before you can manage devices on a map you must add a map or assign a map to a folder and add devices to this folder.



Notice!

After each of the following tasks:



Click  to save the settings.

To place items on a map:

1. Select a map folder.
2. Drag devices from the Device Tree to the map folder.
The devices of a map folder are located on the left upper corner of the map.
3. Drag the items to the appropriate places on the map.

To remove an item in the Logical Tree only from the map:

1. Right-click the item on the map and click **Invisible**.
The item is removed from the map.
The item remains in the Logical Tree.
2. To make it visible again, right-click the device in the Logical Tree and click **Visible In Map**.

To remove an item from the map and from the Full Logical Tree:

- ▶ Right-click the item in the Logical Tree and click **Remove**.
The item is removed from the map and from the Logical Tree.

To change the icon for the orientation of a camera:

- ▶ Right-click the item, point to **Change Image**, and then click the appropriate icon.
The icon changes accordingly.

To change the color of an item:

- ▶ Right-click the item and click to **Change Color**. Select the appropriate color.
The icon changes accordingly.

See also

- *Maps and Structure page, page 342*

18.13 Adding a document



Main window > **Maps and Structure**

You can add text files, HTML files (including MHT files) or an URL file (containing an Internet address) as documents. And you can add a link to another application.

Before you can add a document, you must have document files imported.

To import document files see *Managing resource files, page 176* for details.

To add a map document file:

1. Ensure that the document file that you want to add has already been imported.
2. Select a folder where you want to add the new document.
3. Click . The **Select Resource** dialog box is displayed.

4. Select a file in the list. If the required files are not available in the list, click **Manage...** to display the **Resource Manager** dialog box for importing files.
5. Click **OK**. A new document is added under the selected folder.

See also

- *Select Resource dialog box, page 343*

18.14**Adding a malfunction relay**

Main window >  **Maps and Structure** >  > **Malfunction Relay** dialog box

To add:

1. In the **Malfunction Relay** list, select the desired relay.
2. Click **Events...**
The **Events selection for Malfunction Relay** dialog box is displayed.
3. Click to select the desired events that can trigger the malfunction relay.
4. Click **OK**.
The malfunction relay is added to the system.

See also

- *Malfunction Relay dialog box, page 346*

19 Configuring schedules



Main window > **Schedules**

There are two schedule types available:

- Recording Schedules
- Task Schedules

You can configure a maximum of 10 different Recording Schedules in the Recording Schedule Table. In these segments the cameras can behave differently. For example, they can have different frame rate and resolution settings (to be configured in the **Cameras and Recording** page). In every point in time, exactly one Recording Schedule is valid. There are no gaps and no overlaps.

You configure Task Schedules for scheduling various events which can occur in your system (to be configured in the **Events** page).



See glossary for definitions of Recording Schedules and Task Schedules.

The schedules are used in other pages of the Configuration Client:

- **Cameras and Recording** page
Used to configure recording.
- **Events** page
Used to determine when events cause logging, alarms, or execution of Command Scripts.
- **User Groups** page
Used to determine when the members of a user group can log on.

Follow these references to get detailed information on the available application windows:

- *Recording Schedules page, page 348*
- *Task Schedules page, page 349*

- ▶ Click  to save the settings.
- ▶ Click  to undo the last setting.
- ▶ Click  to activate the configuration.

19.1 Configuring a Recording Schedule



Main window > **Schedules**

You can add exception days and holidays to any Recording Schedule. These settings override the normal weekly settings.

The sequence of decreasing priority is: exception days, holidays, weekdays.

The maximum number of Recording Schedules is 10. The first three entries are configured by default. You can change these settings. Entries with the gray icon  do not have a time period configured.

Recording Schedules share the same weekdays.

Each Standard Task Schedule has its own weekdays patterns.

To configure a Recording Schedule:

1. In the **Recording Schedules** tree, select a schedule.
2. Click the **Weekdays** tab.

- In the **Schedule Table** field, drag the pointer to select the time periods for the selected schedule. The selected cells are displayed in the color of the selected schedule.

Notes:

- You can mark a time period on a weekday of a Recording Schedule with the color of another Recording Schedule.

See also

- Recording Schedules page, page 348*



19.2 Adding a Task Schedule



Main window > **Schedules**

To add a Task Schedule:

- Click **Add**.
A new entry is added.
- Enter the appropriate name.
- Click **Standard** for a standard Task Schedule or **Recurring** for a recurring Task Schedule.
If you change the setting, a message box is displayed. Click **OK** if you want to change the schedule type.

- A standard Task Schedule is displayed as , a recurring Task Schedule as .
- Make the appropriate settings for the selected schedule.

See also

- Task Schedules page, page 349*

19.3 Configuring a standard Task Schedule



Main window > **Schedules**

Each standard Task Schedule has its own weekdays patterns.

To configure a standard Task Schedule:

- In the **Task Schedules** tree, select a standard Task Schedule.
- Click the **Weekdays** tab.
- In the **Schedule Table** field, drag the pointer to select the time periods for the selected schedule.

See also

- Task Schedules page, page 349*

19.4 Configuring a recurring Task Schedule



Main window > **Schedules**

Each recurring Task Schedule has its own day pattern.

To configure a recurring Task Schedule:

- In the **Task Schedules** tree, select a recurring Task Schedule .

2. In the **Recurrence Pattern** field, click the frequency with which you want the Task Schedule to recur (**Daily, Weekly, Monthly, Yearly**) and then make the corresponding settings.
3. In the **Start date:** list, select the appropriate start date.
4. In the **Day Pattern** field, drag the pointer to select the appropriate time period.

See also

- *Task Schedules page, page 349*

19.5 Removing a Task Schedule



Main window >  > Select an item in the **Task Schedules** tree

To remove a Task Schedule:

1. In the **Task Schedules** tree, select an item.
2. Click **Delete**.
The Task Schedule is deleted. All items that are assigned to this schedule, are not scheduled.

See also

- *Task Schedules page, page 349*

19.6 Adding holidays and exception days



Main window >  **Schedules**

Caution!

You can configure empty exception days and holidays. Exception days and holidays replace the schedule of the corresponding week day.

Example:

Old configuration:

Weekday schedule configured to be active from 9:00 to 10:00

Exception day schedule configured to be active from 10:00 to 11:00

Result: activity from 10:00 to 11:00

Same behavior is valid for holidays.



You can add holidays and exception days to a Recording Schedule or to a Task Schedule.

Recording Schedules share the same holidays and exception days.

Each standard Task Schedule has its own holidays or exception days patterns.

To add holidays and exception days to a schedule:

1. In the **Recording Schedules** or **Task Schedules** tree, select a schedule.
2. Click the **Holidays** tab.
3. Click **Add**.
The **Add Holiday(s)** dialog box is displayed.
4. Select one or more holidays and click **OK**.
The selected holidays are added to the Schedule Table.
5. Drag the pointer to select the appropriate time period (this is not possible for Recording Schedules).
The selected cells are cleared and vice versa.

6. Click the **Exception Days** tab.
7. Click **Add**.
The **Add Exception Day(s)** dialog box is displayed.
8. Select one or more special days and click **OK**.
The selected exception days are added to the Schedule Table.
9. Drag the pointer to select the appropriate time period (this is not possible for Recording Schedules).
The selected cells are cleared and vice versa.
The sorting order of the added holidays and exception days is chronological.

Notes:

- You can mark a time period on a holiday or exception day of a Recording Schedule with the color of another Recording Schedule.

See also

- *Recording Schedules page, page 348*
- *Task Schedules page, page 349*

19.7

Removing holidays and exception days



Main window > **Schedules**

You can remove holidays and exception days from a Recording Schedule or a Task Schedule.

To remove holidays and exception days from a Task Schedule:

1. In the **Recording Schedules** or **Task Schedules** tree, select a schedule.
2. Click the **Holidays** tab.
3. Click **Delete**.
The **Select the holidays to delete** dialog box is displayed.
4. Select one or more holidays and click **OK**.
The selected holidays are removed from the Schedule Table.
5. Click the **Exception Days** tab.
6. Click **Delete**.
The **Select the exception days to delete.** dialog box is displayed.
7. Select one or more exception days and click **OK**.
The selected exception days are removed from the Schedule Table.

See also

- *Recording Schedules page, page 348*
- *Task Schedules page, page 349*

19.8

Renaming a schedule



Main window >

To rename a schedule:

1. In the **Recording Schedules** or **Task Schedules** tree, select an item.
2. Click .
3. Enter the new name and press ENTER. The entry is renamed.

See also

- *Recording Schedules page, page 348*
- *Task Schedules page, page 349*

20 Configuring cameras and recording settings





Main window > **Cameras and Recording**

This chapter provides information on how to configure the cameras in your Bosch VMS. You configure various camera properties and the recording settings.

Follow these references to get detailed information on the available application windows:

- *Cameras page, page 350*
- *Scheduled Recording Settings dialog box (only VRM and Local Storage), page 353*
- Stream Quality Settings dialog box
- *COM1, page 311*
- *PTZ/ROI Settings dialog box, page 357*
- Copy Recording Settings dialog box (NVR only)

- ▶ Click  to save the settings.
- ▶ Click  to undo the last setting.
- ▶ Click  to activate the configuration.

20.1 Copying and pasting in tables

You can configure many objects simultaneously within a Camera Table, an Event Configuration Table, or an Alarm Configuration Table.

You can copy the configurable values of a table row in other rows:

- Copy all values of a row to other rows.
- Copy only one value of a row to another row.
- Copy the value of one cell to a complete column.

You can copy the values in two different ways:

- Copy into the clipboard and then paste.
- Direct copy and paste.

You can determine in which rows to paste:

- Copy in all rows.
- Copy in selected rows.

To copy and paste all configurable values of a row into another row:

1. Right-click the row with the desired values and click **Copy Row**.
2. Click the row heading of the row that you want to modify.
To select more than one row press the CTRL key and point to the other row headings.
3. Right-click the table and click **Paste**.
The values are copied.

To copy and paste one value of a row into another row:

1. Right-click the row with the desired values and click **Copy Row**.
2. Right-click the cell that you want to modify, point to **Paste Cell to**, and click **Current Cell**.
The value is copied.

To copy all configurable values directly:

1. Click the row heading of the row that you want to modify.
To select more than one row press the CTRL key and point to the other row headings.

- Right-click the row with the desired values, point to **Copy Row to**, and click **Selected Rows**.

The values are copied.

To copy one value directly:

- Click the row heading of the row that you want to modify.
To select more than one row press the CTRL key and point to the other row headings.
- Right-click the cell with the desired value, point to **Copy Cell to**, and click **Selection in Column**.

The value is copied.

To copy a value of a cell to all other cells in this column:

- Right-click the cell with the desired value, point to **Copy Cell to**, and click **Complete Column**.

The value is copied.

To duplicate a row:

- Right-click the row and click **Add Duplicated Row**.

The row is added below with a new name.

See also

- Cameras page, page 350
- Scheduled Recording Settings dialog box (only VRM and Local Storage), page 353
- Events page, page 359
- Alarms page, page 364

20.2 Exporting the Camera Table



Main window > **Cameras and Recording**
Or



Main window > **Cameras and Recording** > Click an icon to change the Cameras page

according to the desired storage device, for example 

Displays various information on the cameras available in your Bosch VMS.

You can export the Camera Table into a CSV file.

To export:

- Right-click anywhere in the Camera Table and click **Export table...**
- In the dialog box, type in an appropriate filename.
- Click **Save**.

The selected Camera Table is exported in a csv file.

20.3 Configuring stream quality settings

To add a stream quality settings entry:

- Click  to add a new entry in the list.
- Type in a name.

To remove a stream quality settings entry:

- ▶ Select an entry in the list and click  to delete the entry.
You cannot delete default entries.

To rename a stream quality settings entry:

1. Select an entry in the list.
2. Enter the new name in the **Name** field.
You cannot rename default entries.
3. Click **OK**.

To configure stream quality settings:

1. Select an entry in the list.
2. Make the appropriate settings.

20.4

Configuring camera properties

Main window >  **Cameras and Recording** > 

To change camera properties:

1. In the **Camera** column, click a cell and type a new name for the camera.
This name is displayed in all other places where cameras are listed.
2. Make the appropriate settings in the other columns.

For detailed information on the various fields, see the Online Help for the appropriate application window.

See also

- *Cameras page, page 350*

20.5

Configuring recording settings (only VRM and Local Storage)

Main window >  **Cameras and Recording** > 

You can configure the recording settings of all devices that are added to the VRM Devices item in the Device Tree.

Note: For recording, ensure that the corresponding VRM or local storage is properly configured.

VRM: **Devices** > Expand  > 

Local Storage: **Devices** > Expand  > 

To add a recording settings entry:

1. Click  to add a new entry in the list.
2. Type in a name.

To remove a recording settings entry:



- ▶ Select an entry in the list and click  to delete the entry.
You cannot delete default entries.

To rename a recording settings entry:

1. Select an entry in the list.

2. Enter the new name in the **Name:** field.
You cannot rename default entries.
3. Click **OK**.

To configure recording settings:

1. Select an entry in the list.
2. Make the appropriate settings and click **OK**.
3. Click  or .
4. In the **Recording** column, select the desired recording setting for each encoder.
For detailed information on the various fields, see the Online Help for the appropriate application window.

See also

- *Scheduled Recording Settings dialog box (only VRM and Local Storage), page 353*

20.6

Configuring recording settings (NVR only)

Main window >  **Cameras and Recording** > Click  > Click a Recording Schedule

tab (for example )

Before you configure the recording settings, configure the stream quality levels.

Note: For recording, ensure that the corresponding NVR is configured properly (**Devices** >

Expand  >  > **Disk Storage** tab).



Notice!

For all encoders, live view settings are also used for pre-event recording.

For encoders that support dual-streaming, the settings for live/pre-event recording, motion recording, and alarm recording are all configured independently.





For encoders that support only a single stream (e.g., the VideoJet 8004), live viewing and recording use the same stream. In this case, the recording settings take priority, so the live view uses the stream quality settings for continuous, motion, and alarm recording. You can enter a setting for live/pre-event only if continuous recording is disabled.



You can switch the live stream from stream 2 (default) to stream 1 for a workstation

(**Devices** > Expand  >  > **Settings** tab > **Override settings from "Cameras and Recording" page**) or for an encoder. This setting does not affect pre-event recording.



To configure recording settings:

1. In the  column of **Continuous Recording**, select the desired stream quality or disable continuous recording.
2. In the  column, select a check box to activate audio.
3. In the  column of **Live/Pre-event Recording**, select the desired stream quality or select stream 1.
4. In the  column, select a check box to activate audio.
5. In the  column of **Motion Recording**, select the desired stream quality or disable motion recording.

6. In the  column, select a check box to activate audio.
7. In the **Pre-event [s]** column, click a cell and type the appropriate time.
8. In the **Post-event [s]** column, click a cell and type the appropriate time.
9. In the  column of **Alarm Recording**, select the desired stream quality or disable alarm recording.
10. In the  column, select a check box to activate audio.
11. In the **Pre-event [s]** column, click a cell and type the appropriate time.
12. In the **Post-event [s]** column, click a cell and type the appropriate time.



Notice!

If pre-event time for motion recording and pre-event time for alarm recording differ, the higher value is used for both.

If the configured pre-event time would overlap a preceding alarm or motion recording, the pre-event recording starts after the preceding recording is finished.

For detailed information on the various fields, see the Online Help for the appropriate application window.

See also

- *Cameras page, page 350*

20.7

Configuring PTZ port settings

Main window >  **Devices** > Expand  > Expand  > Expand  >  > **Interfaces** tab > **Periphery** tab

or

Main window >  **Devices** > Expand  > Expand  >  > **Interfaces** tab > **Periphery** tab

or

Main window >  **Devices** >  >  > **Interfaces** tab > **Periphery** tab

You can only configure port settings for an encoder where the control of the camera is available and activated.

When the encoder or PTZ camera is exchanged, the port settings are not retained. You must again configure them.

After a firmware update check the port settings.

To configure the port settings of an encoder:

- ▶ Make the appropriate settings.
The settings are valid immediately after saving. You do not have to activate the configuration.

For detailed information on the various fields, see the Online Help for the appropriate application window.

See also

- *Periphery page, page 311*

20.8 Configuring PTZ camera settings





Main window > **Cameras and Recording** >

First configure the port settings of your PTZ camera before you can configure the PTZ camera settings. Otherwise the PTZ control is not working in this dialog box.

You can remove menu items of the context menu displayed on a PTZ camera hot spot on a map.

To configure the control of a camera:

1. In the Camera Table, select the required encoder.
2. To activate the control of a camera: In the  column, select the check box.
3. Click the  button.
The dialog box for configuring PTZ settings is displayed.
4. Remove the prepositions that you do not want to be displayed as context menu items on a map.
5. Make the appropriate settings.
6. Click **OK**.

For detailed information on the various fields, follow the link to the appropriate application window below.

See also

- *PTZ/ROI Settings dialog box, page 357*
- *Configuring PTZ port settings, page 192*

20.9 Configuring the ROI function



Main window > **Cameras and Recording** >

You can enable the ROI function for a fixed HD camera.

You must configure stream 2 for live video and you must configure the H.264 MP SD ROI codec for stream 2.

Ensure that stream 2 is used for live video on each workstation where ROI is to be used.

To enable ROI:

1. In the **Stream 2 - Codec** column, select the H.264 MP SD ROI codec.
2. In the **Live Video - Stream** column, select **Stream 2**.
3. In the **Live Video - ROI** column, click to select the check box.

To disable ROI:

1. In the **Live Video - ROI** column, click to disable the check box.
2. In the **Stream 2 - Codec** column, select the desired codec.

See also

- *Cameras page, page 350*

20.10 Configuring predefined positions for the ROI function



Main window > **Cameras and Recording** >

You can configure the predefined positions for using ROI like for a PTZ camera. You cannot configure Aux commands for ROI.

To configure:

1. In the Camera Table, select the desired camera for which ROI is enabled.
2. Click . The **PTZ/ROI Settings** dialog box is displayed.
3. In the **Predefined Positions** tab, define predefined positions as required.
4. Click **OK**.

See also

- *PTZ/ROI Settings dialog box, page 357*

20.11 Configuring the ANR function



Main window > **Cameras and Recording** >

Before you enable the ANR function, you must add the storage media of an encoder to the desired encoder and configure this storage media.

You must disable dual recording for the encoder to configure ANR.

The ANR function only works on encoders with firmware version 5.90 or later. Not all encoder types support ANR even if the correct firmware version is installed.

To enable:

- ▶ In the row of the desired camera, in the **ANR** column, select the checkbox.

See also

- *Configuring dual recording in the Camera Table, page 194*
- *Cameras page, page 350*
- *Configuring the storage media of an encoder, page 142*

20.12 Configuring dual recording in the Camera Table



Main window > **Cameras and Recording** >

You must disable the ANR function to configure dual recording.

If you configure dual recording for one camera of a multi-channel encoder, the system ensures that the same recording target is configured for all cameras of this encoder.

To configure:

1. In the **Secondary Recording - Target** column, click a cell of the desired encoder and then click the desired pool of a Secondary VRM. Automatically all cameras of the affected encoder are configured to be recorded to the selected Secondary VRM.
2. In the **Setting** column, select a scheduled recording setting.

See also

- *Configuring dual recording in the Device Tree, page 133*
- *Configuring the ANR function, page 194*
- *Dual / failover recording, page 40*
- *Cameras page, page 350*

21 Configuring events and alarms



Main window > **Events**
or



Main window > **Alarms**

This chapter provides information on how to configure events and alarms in your system. The available events are grouped beyond their corresponding devices.

In the **Events** page, you configure when an event in your Bosch VMS triggers an alarm, executes a Command Script, and is logged.

Example (part of an Event Configuration Table):

Settings for 'Video Signal Lost'						
Device	Network	Trigger Alarm	Log	Script		
Name	Address	Schedule	Schedule	Script	Schedule	
Camera 1	172.26.4...	<input checked="" type="radio"/> Always	<input checked="" type="radio"/> Always	<none>	<input checked="" type="radio"/> Never	
Camera 2	172.26.4...	<input checked="" type="radio"/> Always	<input checked="" type="radio"/> Always	<none>	<input checked="" type="radio"/> Never	
Camera 3	172.26.4...	<input checked="" type="radio"/> Always	<input checked="" type="radio"/> Always	<none>	<input checked="" type="radio"/> Never	
Camera 4	172.26.4...	<input checked="" type="radio"/> Always	<input checked="" type="radio"/> Always	<none>	<input checked="" type="radio"/> Never	

This example means:



If the video signal of the selected camera gets lost, an alarm is triggered, the event is logged, and no script is executed.

In **Alarms**, you define how an alarm is displayed, and which cameras are displayed and recorded in case of an alarm.

Some system events are configured as alarms by default.

Follow these references to get detailed information on the available application windows:

- *Command Script Editor dialog box, page 361*
- *Create Compound Event / Edit Compound Event dialog box, page 362*
- *Select Script Language dialog box, page 362*
- *Alarm Settings dialog box, page 365*
- *Select Image Pane Content dialog box, page 365*

- *Alarm Options dialog box, page 366*
- ▶ Click  to save the settings.
- ▶ Click  to undo the last setting.
- ▶ Click  to activate the configuration.

21.1 Copying and pasting in tables

You can configure many objects simultaneously within a Camera Table, an Event Configuration Table, or an Alarm Configuration Table with a few clicks.

For detailed information, see *Copying and pasting in tables, page 188*.

21.2 Removing a table row



Main window > **Alarms**

You can only remove a table row that you or another user have added, i.e. you can delete duplicated events or Compound Events.

Compound Events are located in the Event Tree under **System Devices > Compound Events**.

To remove a table row:

1. Select the row.
2. Click .

See also

- *Events page, page 359*

21.3 Managing resource files

For detailed information see:

- *Managing resource files, page 176*.

21.4 Configuring an event



Main window > **Events**

To configure an event:

1. In the tree, select an event or event state, for example **System Devices > Authentication > Operator Authentication Rejected**.
The corresponding Event Configuration Table is displayed.
2. In the **Trigger Alarm - Schedule** column, click a cell and select the appropriate schedule.
The schedule determines when the alarm is triggered.
Select one of the Recording Schedules or Task Schedules that you have configured in the **Schedules** page.
3. In the **Log - Schedule** column, click a cell and select the appropriate schedule.
The schedule determines when the event is logged.
4. In the **Script - Script** column, click a cell and select an appropriate Command Script.

- In the **Script - Schedule** column, click a cell and select the appropriate schedule. The schedule determines when the event triggers the start of the Command Script.

See also

- *Events page, page 359*

21.5 Duplicating an event



Main window > **Events**

You can duplicate an event to trigger different alarms for a particular event.

To duplicate an event:

- In the tree, select an event condition. The corresponding Event Configuration Table is displayed.
- Select a table row.
- Click . A new table row is added below. It has the default settings.

See also

- *Events page, page 359*

21.6 Logging user events



Main window > **Events** > Expand **System Devices** > **User Actions**

You can configure the logging behavior of several user actions for each available user group individually.

Example:

To log user events:

- Select a user event to configure its logging behavior, e.g. **Operator Logon**. The corresponding Event Configuration Table is displayed. Each user group is displayed in the **Device** column.
- If available: In the **Trigger Alarm - Schedule** column, click a cell and select the appropriate schedule. The schedule determines when the alarm that is supposed to notify the user is triggered. You can select one of the Recording Schedules or Task Schedules that you have configured in **Schedules**.
- In the **Log - Schedule** column, click a cell and select the appropriate schedule. The schedule determines when the event is logged. In the example, the Operator logon of the Admin Group and the Power User Group are not logged whereas the Operator logon of the Live User Group are logged during **Day** schedule.

See also

- *Events page, page 359*

21.7 Configuring user event buttons



Main window > **Events**

You can configure the user event buttons available in the Operator Client. You can configure that one or more user event buttons are not displayed in the Operator Client.

On the **User Groups** page, you configure that the user event buttons are only available in the Operator Client of the corresponding user group.

To configure user event buttons:

1. In the tree, select **System Devices > Operator Client Event Buttons > Event Button Pressed**.
The corresponding Event Configuration Table is displayed.
2. Select a user event button to configure its behavior.
3. In the **Trigger Alarm - Schedule** column, click a cell and select the appropriate schedule.
The schedule determines when the alarm that is supposed to notify the user is triggered.
4. In the **Log - Schedule** column, click a cell and select the appropriate schedule.
The schedule determines when the event is logged.
Selecting **Never** makes the user event button unavailable in the Operator Client of all user groups that have the user event button permission.
5. In the **Script - Script** column, click a cell and select an appropriate Command Script.
6. In the **Script - Schedule** column, click a cell and select the appropriate schedule.
The schedule determines when the Command Script is executed.

See also

- *Events page, page 359*

21.8 Creating a Compound Event



Main window > **Events**

You create a Compound Event. You can combine only state changes and their objects. Objects can be for example schedules or devices. You can combine both the state changes and their objects with the Boolean expressions AND and OR.

Example: You combine the connection states of an IP camera and a decoder. The Compound Event shall only occur when both the devices loose their connection. In this case you use the AND operator for the two objects (the IP camera and the decoder) and for the two connection states **Video Signal Lost** and **Disconnected**.

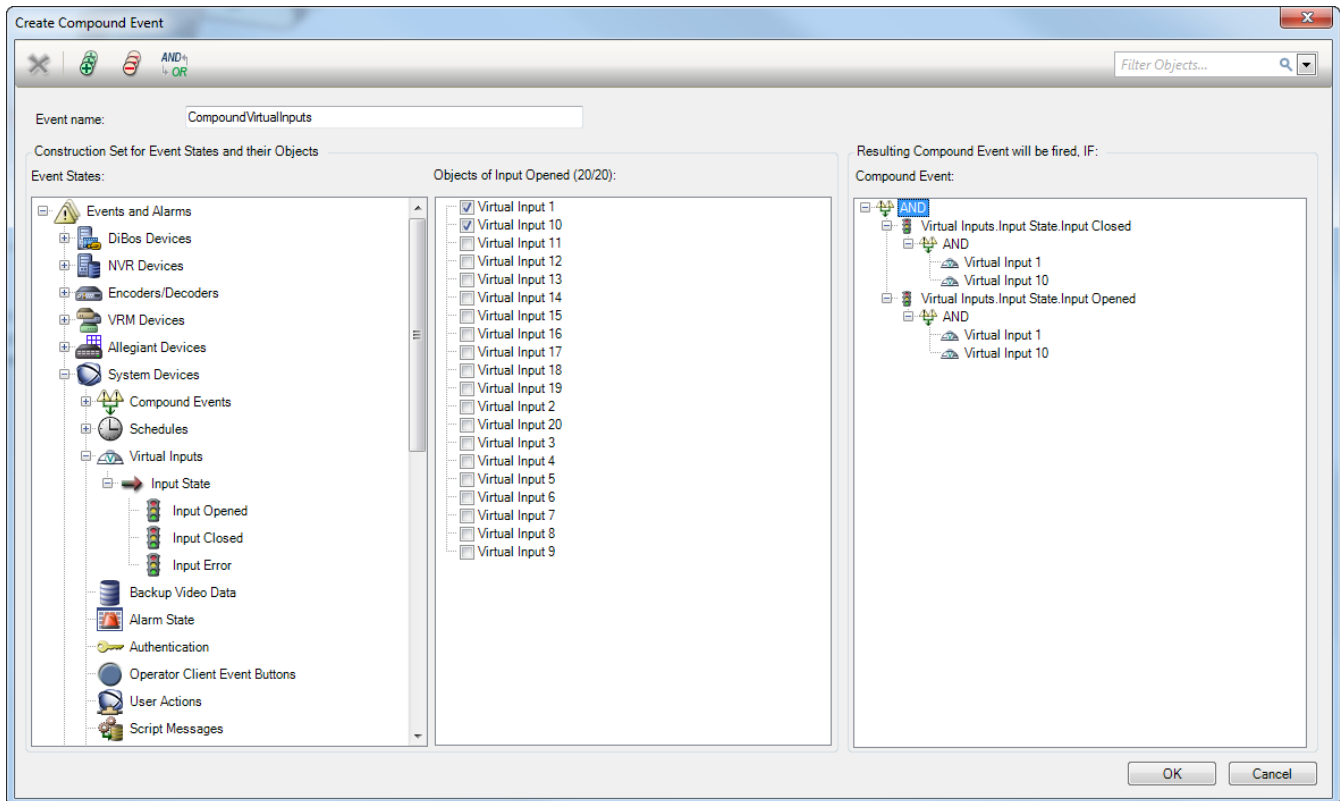

To create a Compound Event:

1. In the **Event name:** field, enter a name for the Compound Event.
2. In the **Event States:** field, select an event state.
The available objects are displayed in the **Objects:** field.
3. In the **Objects:** field select device as required.
The corresponding event and the selected devices are added to the Compound Event pane.
4. In the **Compound Event:** field, right-click a Boolean operation and change it where required.
A Boolean operation defines the combination of its immediate child elements.
5. Click **OK**.
The new Compound Event is added to the Event Configuration Table. You find it in the Event Tree below **System Devices**.

See also

- *Events page, page 359*

21.9 Editing a Compound Event



Main window > **Events**

You can change a previously created Compound Event.

To edit a Compound Event:

1. In the Event Tree, expand **System Devices** > **Compound Event State** > **Compound Event is True**.

2. In the Event Configuration Table, in the **Device** column, right-click the required Compound Event and click **Edit**.
The **Edit Compound Event** dialog box is displayed.
3. Make the required changes.
4. Click **OK**.
The Compound Event is changed.

See also

- *Events page, page 359*

21.10 Configuring an alarm



Main window > **Alarms**

Before configuring an alarm you must configure the trigger in **Events**.

To configure an alarm:

1. In the tree, select an alarm, for example **System Devices > Authentication > Operator Authentication Rejected**.
The corresponding Alarm Configuration Table is displayed.
2. In the **Priority** column, click ... in a cell to type the alarm priority for the selected alarm (100 is low priority, 1 is high priority).
In the **Title** column, click ... in a cell to type the title of the alarm to be displayed in Bosch VMS, for example in the Alarm List.
In the **Color** column, click ... in a cell to display a dialog box for selecting a color for the alarm to be displayed in the Operator Client, for example in the Alarm List.
3. In the 1-5 columns, click ... in a cell to display the **Select Image Pane Content** dialog box. Make the required settings.
4. In the **Audio File** column, click ... in a cell to display a dialog box for selecting an audio file that is played in case of an alarm.
5. In the **Alarm Options** column, click ... in a cell to display the **Alarm Options** dialog box.
6. Make the required settings.

For detailed information on the various fields, see the Online Help for the appropriate application window.

See also

- *Configuring an event, page 197*
- *Alarms page, page 364*
- *Select Image Pane Content dialog box, page 365*
- *Alarm Options dialog box, page 366*

21.11 Configuring settings for all alarms



Main window > **Alarms**

You can set the following alarm settings that are valid for this Management Server:

- Number of Image panes per alarm
- Auto-clear time
- Manual alarm recording time
- Configure the behavior of all analog monitor groups

To configure all alarms:

1. Click .

The **Alarm Settings** dialog box is displayed.

2. Make the appropriate settings.

For detailed information on the various fields, see the Online Help for the appropriate application window.

- ▶ Click **OK**.

See also

- *Alarm Settings dialog box, page 365*

21.12**Configuring the pre- and post-alarm duration for an alarm**

For configuring pre-alarm and post-alarm duration settings you need a camera that supports ANR and firmware 5.90 or later must be installed.



Main window > **Cameras and Recording** >

- ▶ For the desired camera, click to enable **ANR**.





Main window > **Events**

- ▶ Configure the desired event for the ANR activated camera.



Main window > **Alarms**

1. Configure an alarm for this event.
2. Select  or .
3. In the **Alarm Options** column click ...
The **Alarm Options** dialog box is displayed.
4. In the **Record** column, select the check box of the ANR enabled camera to enable alarm recording.
The check box in the **Deviating Alarm Duration Settings** column is selected automatically.
5. Click the **Deviating Alarm Duration Settings** tab.
6. Configure the alarm duration settings as required.

See also

- *Alarm Options dialog box, page 366*

21.13**Triggering alarm recording with text data**

Main window > **Alarms**

You can trigger alarm recording with text data.

Before configuring an alarm you must configure an event that contains text data.



Example: **Events** > In the Event Tree select  (text data must be available, for example: **Foyer Card Reader Devices** > **Foyer Card Reader** > **Card Rejected**)

**Notice!**

Configure the debounce time for the selected event to 0.
This ensures that no text data is lost.

To configure alarm recording:

1. In the tree, select an alarm, for example **ATM/POS Devices** > **ATM Input** > **Data Input**.
The corresponding Alarm Configuration Table is displayed.
2. Make the required settings.
3. In the **Alarm Options** column, click ... in a cell to display the **Alarm Options** dialog box.
4. Click the **Cameras** tab and click to select the **Record** checkbox.

See also

- *Alarm Options dialog box, page 366*
- *Text Data Recording dialog box, page 363*

21.14**Adding text data to continuous recording**

Main window > **Events** > In the Event Tree select  **Data Input** (text data must be available, for example: **Foyer Card Reader Devices** > **Foyer Card Reader** > **Card Rejected**) > **Text Data Recording** column > ...

You can add text data to continuous recording.

21.15**Protecting alarm recording**

Main window > **Alarms**

Before configuring an alarm you must configure an event in **Events**.





To configure alarm recording:

1. In the tree, select an alarm, for example **ATM/POS Devices** > **ATM Input** > **Data Input**.
The corresponding Alarm Configuration Table is displayed.
2. Make the required settings.
3. In the **Alarm Options** column, click ... in a cell to display the **Alarm Options** dialog box.
4. Click the **Cameras** tab and click to select the **Record** checkbox.
5. Select the **Protect Recording** checkbox.

See also

- *Alarm Options dialog box, page 366*

21.16 Configuring blinking hot spots

For each  event, you can configure the background color and the behavior (blinking or not blinking) for hot spots. For example you can configure for a  event of a device that its device icon on a map starts blinking when the state of this device changes. Additionally you can configure the display priority for all hot spots. This is required when different events occur for the same device. (1 = highest priority) The configured color is valid for all hot spots with the same display priority. You can change color, behavior and priority at any  event: The changed color and behavior is used for all hot spots of all other  events which have the same priority. The configuration of the color states on maps is only possible when you click to check the **Enable advanced state display (hot spot coloring in maps depending on state)** option in the **Options** dialog box.

To configure:



1. In the tree, select an event state (), for example **Encoders/Decoders > Encoder Relay > Relay State > Relay Opened**.
The corresponding Event Configuration Table is displayed.
2. Click **Enable color states on maps**.
3. In the **Display priority on map:** field, enter the desired priority.
4. Click the **Background color on map:** field to select the desired color.
5. If desired, click to enable **Blinking**.

See also

- *Events page, page 359*
- *Options dialog box, page 229*

22 Configuring Command Scripts

This chapter describes how to configure Command Scripts. Command Scripts appear at various places of Bosch VMS.

1. Click  to save the settings.
2. Click  to undo the last setting.
3. Click  to activate the configuration.



Notice!

Server Scripts gets activated during restart of Management Server service even if not activated from within Configuration Client.

22.1 Managing Command Scripts

Main window

You can create a Command Script using the following scripting languages:

- C#
- VB.Net

You cannot change the scripting language of an existing Command Script.

You can create a Client Script or a Server Script.

You can add scriptlets to every script.

To get help on entering code, click  in the **Command Script Editor** dialog box. The Bosch Script API help is displayed.

To add a server scriptlet:

1. On the **Tools** menu, click the **Command Script Editor...** command.
The **Select Script Language** dialog box is displayed if no Command Script was created yet.
2. In the **Script Language:** list, select the required entry.
The **Command Script Editor** dialog box is displayed.
3. In the left pane of the **Command Script Editor** dialog box, right-click ServerScript and click **New Scriptlet**.
A new scriptlet is added.
4. Enter your code.

To add a client scriptlet

1. On the **Tools** menu, click the **Command Script Editor...** command.
The **Select Script Language** dialog box is displayed if no Command Script was created yet.
2. In the **Script Language:** list, select the required entry.
The **Command Script Editor** dialog box is displayed.
3. In the left pane of the **Command Script Editor** dialog box, right-click ClientScript and click **New Scriptlet**.
A new scriptlet is added.
4. Enter your code.

To delete a scriptlet:

1. Open the **Command Script Editor** dialog box.
2. Click the **Server Script** tab or the **Client Script** tab as required.

- In the Event Tree, right-click the required event and click . The scriptlet is removed.

To exit the Command Script Editor dialog box:

- Click .

See also

- Command Script Editor dialog box, page 361*

22.2 Configuring a Command Script to be started automatically

Main window >  **Alarms** >  or  > **Alarm Options** column > ...

You configure a Client Command Script to be started in the following cases:

- Workstation starts up.
- User accepts an alarm.

To configure a Command Script at workstation startup:

See Configuring a startup Command Script.

To configure a Command Script after user has accepted an alarm:

- Click the **Workflow** tab.
- In the **Execute the following Client Script when alarm is accepted:** list, select the desired Client Script.
This script is started as soon as a user accepts the selected alarm.

See also

- Alarm Options dialog box, page 366*

22.3 Importing a Command Script

Main window

You can import Command Scripts that have been developed on another computer. The file must be written in the same scripting language that you used on your system.

To import a Command Script:

- On the **Tools** menu, click the **Command Script Editor...** command.
The **Command Script Editor** dialog box is displayed.
- Click .
- Select the required script file and click **OK**.

See also

- Command Script Editor dialog box, page 361*

22.4 Exporting a Command Script

Main window

You can export Command Scripts that have been developed on another computer.

To export a Command Script:

- On the **Tools** menu, click the **Command Script Editor...** command.
The **Command Script Editor** dialog box is displayed.

2. Click  .
The dialog box for saving a file is displayed.
3. Type the required script file name and click **OK**.

See also

- *Command Script Editor dialog box, page 361*

22.5

Configuring a startup Command Script

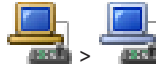

Main window > **Devices** > Expand  > **Settings** page

You configure a Command Script to be started when the Operator Client on the selected workstation is started.

You must create a corresponding Command Script.

For creating a Command Script, see *Managing Command Scripts, page 205*.

To configure a startup script:

- ▶ In the **Startup script:** list, select the required Command Script.

See also

- *Workstation page, page 243*

23 Configuring users, permissions and Enterprise Access



Main window > **User Groups**

This chapter provides information on how to configure user groups, Enterprise User Groups and Enterprise Access. You make all settings per user group and not per user. A user can only be the member of one user group or Enterprise User Group.



You cannot change the settings of a default user group.

This user group has access to all the devices of the Full Logical Tree and is assigned the **Always** schedule.

For accessing the Windows user groups of a domain, LDAP user groups are used.

Follow these references to get detailed information on the available application windows:

- *User Properties page, page 373*
- *New User Group/Enterprise Account dialog box, page 371*
- *User Group Properties page, page 372*
- *Add New Dual Authorization Group dialog box, page 374*
- *LDAP Server Settings dialog box, page 378*
- *Copy User Group Permissions dialog box, page 377*
- *Select User Groups dialog box, page 375*
- *Logical Tree page, page 381*
- *Events and Alarms page, page 378*
- *Operator Features page, page 381*
- *Priorities page, page 384*
- *Camera Permissions page, page 375*
- *Decoder Permissions page, page 377*
- *User Interface page, page 384*

1. Click  to save the settings.
2. Click  to undo the last setting.
3. Click  to activate the configuration.

23.1 Creating a user



Main window > **User Groups > User Groups** tab
or



Main window > **User Groups > Enterprise User Group** tab

You create a user as a new member of an existing user group or Enterprise User Group.



Notice!

A user who wants to operate a Bosch IntuiKey keyboard connected to a decoder, must have a number-only user name and password. The user name can have maximum 3 numbers; the password can have maximum 6 numbers.

To create a user:

1. Select a group and click .
A new user is added to the **User Groups** tree.
2. Right-click the new user and click **Rename**.
3. Enter the desired name and press ENTER.
4. On the **User Properties** page, enter the user name and the password.

See also

- *User Groups page, page 370*

23.2 Creating a group or account



Main window > **User Groups**

You can create a standard user group, an Enterprise User Group or an Enterprise Account. For adapting the user group permissions to your requirements, create a new user group and change its settings.

You perform the task of creating an Enterprise User Group for an Enterprise Management system on the Enterprise Management Server.

You create an Enterprise User Group with users to configure their operating permissions.

These operating permissions are available on an Operator Client that is connected to the Enterprise Management Server. An example of an operating permission is the user interface of the alarm monitor.

You perform the task of creating an Enterprise Account on a Management Server. Repeat this task on each Management Server that is a member of your Enterprise System.

You create an Enterprise Account to configure the device permissions for an Operator Client using an Enterprise System.

To create a group or account:

1. Click the desired tab for the group or account that you want to add:
 - **User Groups**
 - **Enterprise User Group**
 - **Enterprise Access**
2. Click .
The appropriate dialog box is displayed.
3. Type in the name and a description.
4. For an Enterprise Account enter a password and confirm this password.
5. Click **OK**.
A new group or account is added to the corresponding tree.



For detailed information on the various fields, see the Online Help for the appropriate application window.

See also

- *Enterprise System , page 26*
- *Creating an Enterprise System , page 114*
- *User Group Properties page, page 372*
- *Credentials page, page 380*
- *Server Access page, page 385*

- *New User Group/Enterprise Account dialog box, page 371*
- *Add New Dual Authorization Group dialog box, page 374*

23.3 Creating a dual authorization group

Main window >  **User Groups** > **User Groups** tab >  > **New Dual Authorization Group** dialog box

or

Main window >  **User Groups** > **Enterprise User Group** tab >  > **New Enterprise Dual Authorization Group** dialog box

You select two groups. The members of these groups are the members of the new dual authorization group.

You can configure dual authorization for user groups and for Enterprise User Groups.



To create:

1. Type in a name and description.
2. Click .
The appropriate dialog box is displayed.
3. Select a group in each list.
It is possible to select the same group in the second list.
4. For each group, select **Force dual authorization** if required.
When this check box is selected, each user of the first group can only log on together with a user of the second group.
When this check box is cleared, each user of the first group can log on alone but he only has the access rights of his group.



Related Topics

- *Logon Pair Properties page, page 374*
- *Add New Dual Authorization Group dialog box, page 374*
- *Select User Groups dialog box, page 375*

23.4 Configuring LDAP settings

Main window >  **User Groups** > **User Groups** tab >  > **Operating Permissions** tab

or

Main window >  **User Groups** > **Enterprise User Group** tab >  > **Operating Permissions** tab

Caution!

Do not assign an LDAP group to different Bosch VMS user groups. This can result in not intended permissions for these users.



Notice!

Type the search paths accurately. Wrong paths can make the search on an LDAP server very slow.



You configure LDAP groups in standard user groups or Enterprise User Groups.



To configure LDAP settings:

1. Click the **User Group Properties** tab.
2. In the **LDAP Properties** field, make the appropriate settings.

For detailed information on the various fields, see the Online Help for the appropriate application window.

23.5 Associating an LDAP group

Main window >  **User Groups > User Groups tab >**  **> Operating Permissions tab**
or

Main window >  **User Groups > Enterprise User Group tab >**  **> Operating Permissions tab**

You associate an LDAP group with a Bosch VMS user group to give the users of this LDAP group access to the Operator Client. The users of the LDAP group have the access rights of the user group where you configure the LDAP group.

You probably need the help of the IT administrator who is responsible for the LDAP server. You configure LDAP groups in standard user groups or Enterprise User Groups.



To associate an LDAP group:



1. Click the **User Group Properties** tab.
2. In the **LDAP Properties** field, click **Settings**.
The **LDAP Server Settings** dialog box is displayed.
3. Enter the settings of your LDAP server and click **OK**.

For detailed information on the various fields, see the Online Help for the appropriate application window.

- ▶ In the **LDAP groups** list, double-click an LDAP group.
This LDAP group is entered in the **Associated LDAP group** field.

23.6 Scheduling user logon permission

Main window >  **User Groups > User Groups tab >**  **> Operating Permissions tab**
or

Main window >  **User Groups > Enterprise User Group tab >**  **> Operating Permissions tab**



You can limit the members of a user group or Enterprise User Group to log on to their computers at specified time periods.



You cannot change these settings for a default user group.

To schedule logging on:

1. Click the **User Group Properties** tab.
2. In the **Logon schedule** list, select a schedule.

23.7 Configuring operating permissions

Main window >  **User Groups > User Groups** tab >  > **Operating Permissions** tab
or

Main window >  **User Groups > Enterprise User Group** tab >  > **Operating Permissions** tab

You can configure operating permissions like Logbook access or user interface settings. You cannot change these settings for a default user group.

You configure operating permissions in standard user groups or Enterprise User Groups.

To configure operating permissions:



1. Click the **Operator Features** tab.
2. Select or clear the check boxes as appropriate.

For detailed information on the various fields, see the Online Help for the appropriate application window.

See also

- *User Group Properties page, page 372*
- *User Interface page, page 384*
- *Operator Features page, page 381*
- *Server Access page, page 385*
- *Priorities page, page 384*

23.8 Configuring user interface settings

Main window >  **User Groups > User Groups** tab >  > **Operating Permissions** tab
or

Main window >  **User Groups > Enterprise User Group** tab >  > **Operating Permissions** tab

You can configure a multi monitor mode with up to 4 monitors. You set for every monitor what is displayed on it, e.g. monitor 2 only displays Live Image panes or Monitor 1 and Monitor 2 use the 16:9 aspect ratio for HD cameras.

You configure operating permissions in standard user groups or Enterprise User Groups.

To configure user interface settings:

1. Click the **User Interface** tab.

2. In the 4 monitor list, select the required entries.
If you click **Restore Default**, all list entries are reset to their default settings.
3. If required, select the **Save settings when shutting down** check box to enable the user to save his individual settings when shutting down the Operator Client.

23.9 Configuring permissions for Logical Tree

Main window >  **User Groups > User Groups tab > Device Permissions tab**
or

Main window >  **User Groups > Enterprise Access tab > Device Permissions tab**

You can set the permissions for all devices of the Logical Tree independently.
In an Enterprise System, these permissions are valid for the access of Enterprise User Group users to the devices of a local Management Server, controlled by Enterprise Accounts.
After you have moved permitted devices to a folder that is not permitted for this user group, you must set the permissions for the folder to grant access to its devices.
You cannot change these settings for a default user group.
You configure device permissions in standard user groups or Enterprise Accounts.

To configure permissions:

1. In the User Groups tree, select a user group or account.
2. Click the **Logical Tree** tab.
3. Select or clear the check boxes as appropriate.
Selecting an item below a node, automatically selects the node.
Selecting a node, automatically selects all items below.

For detailed information on the various fields, see the Online Help for the appropriate application window.

23.10 Configuring permissions for events and alarms

Main window >  **User Groups > User Groups tab > Device Permissions tab**
or

Main window >  **User Groups > Enterprise Access tab > Device Permissions tab**

You configure which events the user group or account is authorized to process.
You cannot change these settings for a default user group.
You configure permissions for events and alarms in standard user groups or Enterprise Accounts.

To configure permission for events and alarms:

1. In the User Groups tree, select a user group or account.
2. Click the **Events and Alarms** tab.
3. Select the check box to enable all available events and alarms.
Or:
Select the required check boxes to enable the appropriate events and alarms.

See also

– *Events and Alarms page, page 378*

23.11 Configuring camera permissions



Main window > **User Groups > User Groups tab > Device Permissions tab**
or



Main window > **User Groups > Enterprise Access tab > Device Permissions tab**
You can configure various permissions for cameras, e.g. PTZ control.

You cannot change these settings for a default user group.

You configure camera permissions in standard user groups or Enterprise Accounts.

To configure camera permissions:

1. In the User Groups tree, select a user group or account.
2. Click the **Camera Permissions** tab.
3. Select or clear the check boxes as appropriate.

For detailed information on the various fields, see the Online Help for the appropriate application window.

23.12 Configuring decoder permissions



Main window > **User Groups > User Groups tab > Device Permissions tab**
or



Main window > **User Groups > Enterprise Access tab > Device Permissions tab**
You can configure permissions for decoders.

You cannot change these settings for a default group.

You configure decoder permissions in standard user groups or Enterprise Accounts.

To configure decoder permissions:

1. In the User Groups tree, select a user group or account.
2. Click the **Decoder Permissions** tab.
3. Select or clear the check boxes as appropriate.

See also

– *Decoder Permissions page, page 377*

23.13 Configuring various priorities



Main window > **User Groups > User Groups tab**
or



Main window > **User Groups > Enterprise User Group tab**

or



Main window > **User Groups > Enterprise Access** tab

You can configure the following priorities:

- For standard user groups and **Enterprise User Group**: You can configure the alarm priorities for Live Mode and Playback Mode.
- For standard user groups and **Enterprise Access**: You can configure the priorities for acquiring PTZ controls and Bosch Allegiant trunk lines.
You can configure a time period for PTZ locking, i.e. a user with higher priority can take over the camera control from a user with a lower priority and locks it for this time period.

To configure live and playback priorities:

1. Select a standard user group or an Enterprise User Group.
2. Click **Operating Permissions** .
3. Click the **Priorities** tab.
4. In the **Automatic Popup Behavior** field, move the sliders as required.

To configure priorities for PTZ and Bosch Allegiant trunk lines:

1. Select a standard user group or an Enterprise Account.
2. Click **Device Permissions** tab.
3. Click the **Control Priorities** tab.
4. In the **Control Priorities** field, move the sliders as required.
5. In the **Timeout in min.** list, select the required entry.

23.14 Copying user group permissions



Main window > **User Groups > User Groups** tab

or



Main window > **User Groups > Enterprise User Group** tab

or



Main window > **User Groups > Enterprise Access** tab

You can copy permissions from one group or account to another. You must have configured at least 2 groups or accounts.

To copy permissions:

1. In the User Groups tree, select a group or account.
2. Click  .
The **Copy User Group Permissions** dialog box is displayed.
3. Select the appropriate permissions and the appropriate target group or account.
4. Click **OK**. The group permissions of this group are copied to the other group or account.
The dialog box is closed.

24 Managing configuration data

Main window

You must activate the current configuration to make it valid for the Management Server and Operator Client. The system reminds you to activate when exiting the Configuration Client. Every activated configuration is saved with the date and with a description if required. At every point in time you can restore a recently activated configuration. All configurations saved in the meantime get lost.

You can export the current configuration in a configuration file and import this file later. This restores the exported configuration. All configurations saved in the meantime get lost.

24.1 Activating the working configuration

Main window

You activate the currently working configuration. The Operator Client uses the activated configuration after the next start if the user accepted it. If the activation is enforced, all open instances of the Operator Client in the network exit and start again. The user of each Operator Client instance usually does not have to log on again.

You can configure a delayed activation time. If you configure a delayed activation time, the working configuration is not activated at once but at the time configured. If you configure another activation time later (delayed or not does not matter), this time is active now. The first configured activation time is removed.

When you exit the Configuration Client the system reminds you to activate the current working copy of the configuration.

You cannot activate a configuration that contains a device without password protection.



Notice!

If the activation is enforced, each instance of Operator Client restarts when the configuration is activated. Avoid unnecessary activations. Perform activations preferably in the night or during time periods with low activities.



Notice!

If your system contains devices that are not protected by a password, you must secure these devices before you can activate. You can deactivate this password enforcement.

To activate the currently working configuration:

1. Click  .

The **Activate Configuration** dialog box is displayed.

If your configuration contains devices that are not protected by a password, you cannot activate. In this case the **Protect Devices with Default Password...** dialog box is displayed.

Follow the instructions in this dialog box and click **Apply**.

The **Activate Configuration** dialog box is displayed again.

2. If appropriate, enter a delayed activation time. By default, the present point in time is configured as activation time. If you do not change the delayed activation time, the activation is performed immediately.

If appropriate, click to check **Force activation for all Operator Clients**.

3. Type a description and click **OK**.
The current configuration is activated.
Each Operator Client workstation is instantly restarted, if connected to the network and the activation is enforced. If a workstation is not connected, it is restarted as soon it is connected again.
If you configured a delayed activation time, the configuration will be activated later.

See also

- *Protect Devices with Global Default Password dialog box, page 227*
- *Activate Configuration dialog box, page 226*

24.2 Activating a configuration

Main window

You can activate a previous version of the configuration that you have saved earlier.

To activate a configuration:

1. On the **System** menu, click **Activation Manager...**
The **Activation Manager** dialog box is displayed.
2. In the list, select the configuration you want to activate.
3. Click **Activate**.
A message box is displayed.
4. Click **OK**.
The **Activate Configuration** dialog box is displayed.
5. If appropriate, click to check **Force activation for all Operator Clients**. Each Operator Client workstation is automatically restarted to activate the new configuration. The user cannot refuse the new configuration.
If **Force activation for all Operator Clients** is not checked, on each Operator Client workstation a dialog box appears for some seconds. The user can refuse or accept the new configuration. The dialog box is closed after a few seconds without user interaction. In this case the new configuration is not accepted.

See also

- *Activate Configuration dialog box, page 226*
- *Activation Manager dialog box, page 225*

24.3 Exporting configuration data

Main window

You can export the device configuration data of Bosch VMS in a .zip file. This .zip file contains the database file (`Export.bvms`) and the user data (.dat file).

You can use these files for restoring a system configuration that has been exported before on the same (Enterprise) Management Server or for importing it on another (Enterprise) Management Server. The user data file cannot be imported but you can use it to manually restore the user configuration.

To export configuration data:

1. On the **System** menu, click **Export Configuration....**
The **Export Configuration File** dialog box is displayed.

Note: If your current working copy configuration is not activated ( is active), you export this working copy and not the activated configuration.

2. Click **Save**.

3. Enter a filename.
The current configuration is exported. A .zip file with database and user data is created.

See also

- *Importing configuration data, page 218*

24.4 Importing configuration data

Main window

The following use cases are covered:

- Importing a configuration that has been exported (backup has been performed) before on the same server
- Importing a configuration template that has been prepared and exported on another server
- Importing the configuration of an earlier Bosch VMS version.

You can only import a configuration if the latest changes of the current working copy are saved and activated.

For importing the configuration data you need the appropriate password.

You cannot import user data.

To import the configuration:

1. On the **System** menu, click **Import Configuration...**
The **Import Configuration File** dialog box is displayed.
2. Select the desired file for import and click **Open**.
The **Import Configuration...** dialog box is displayed.
3. Enter the appropriate password and click **OK**.
The Configuration Client is restarted. You must logon again.
The imported configuration is not activated but editable in Configuration Client.

**Notice!**

If you want to continue editing the configuration that has been activated for your Management Server, perform a rollback in the **Activate Configuration** dialog box.

See also

- *Exporting configuration data, page 217*

24.5 Exporting configuration data to OPC

Main window

You can export the device configuration data of Bosch VMS in an XML file to import it in an OPC Server application. The file must be stored in the bin directory of your Bosch VMS installation.

For configuring a Bosch VMS - BIS connection the Bosch VMS - BIS Interface Configuration Manual is available.

Caution!

Install OPC server and Bosch VMS Management Server on different computers. If both the servers run on the same computer, the performance of the systems is reduced. Additionally serious software crashes can appear.

To export configuration data:

1. On the **System** menu, click **Export Device Information for OPC...**
The **Export Device Information File** dialog box is displayed.

2. Enter a file name and click **Save**.
The file is saved.
You can import this file in your OPC server application.

24.6 Checking the status of your encoders/decoders

Main window > **Hardware** menu > **Device Monitor...** command > **Device Monitor** dialog box
You can check the status of all activated encoders/decoders in the Device Tree.

See also

- *Device Monitor dialog box, page 231*

24.7 Configuring SNMP monitoring

Main window

To configure:

1. On the **Settings** menu, click **SNMP Settings....**
The **SNMP Settings** dialog box is displayed.
2. Make the required settings and click **OK**.

To disable SNMP GetRequest:

- ▶ In the **SNMP GET port** field, delete the content of the field.
Bosch VMS no longer listens to SNMP GetRequest.

See also

- *SNMP Settings dialog box, page 232*

24.8 Creating a report

Main window

You can create reports where information on the current configuration is collected.

To create a report:

1. On the **Reports** menu, click the desired command.
The corresponding dialog box is displayed.
2. Click **CSV Export**.
3. Enter path and filename for the new report.
4. Open the CSV file in Microsoft Excel or another spreadsheet application to check the content.

See also

- *Recording Schedules dialog box, page 228*
- *Task Schedules dialog box, page 228*
- *Cameras and Recording Parameters dialog box, page 228*
- *Stream Quality Settings dialog box, page 228*
- *Event Settings dialog box, page 229*
- *Compound Event Settings dialog box, page 229*
- *Alarm Settings dialog box, page 229*
- *Configured Users dialog box, page 229*
- *User Groups and Accounts dialog box, page 229*
- *Operating Permissions dialog box, page 229*

25 Configuration examples

This chapter contains examples on how to configure selected devices in Bosch VMS.

25.1 Adding a Bosch ATM/POS bridge



This example describes how to set up a Bosch ATM/POS bridge.

Configuring the ATM/POS bridge





1. Ensure that the device is powered.
2. To configure the IP address and subnet mask of the device connect it to a COM port of your computer with a RS232 cable (use the specified Bosch cable for connection). See the Installation Manual of the Bosch ATM/POS bridge for details.
3. On this computer, start a Hyper terminal session (usually: **Start > Programs > Accessories > Communications > Hyper Terminal**).
4. Type a name for the session and click **OK**.
5. Select the COM port number and click **OK**.
6. Enter the following COM port settings:
 - 9600 bits/s
 - 8 data bits
 - no parity
 - 1 stop bit
 - hardware flow control
 Click **OK**.
7. Press F1 for displaying the system options menu of the device.
8. Enter 1 to set the IP address and the subnet mask as required.
9. Leave the default settings for the ports:
 - port1: **4201**
 - port2: **4200**

Adding the ATM/POS bridge to Bosch VMS

1. Connect the device to your Bosch VMS network.
2. Start Configuration Client.

3. Click  **Devices**, expand the Logical Tree, expand , right-click , click **Add Bosch ATM/POS-Bridge**.



The **Add Bosch ATM/POS-Bridge** dialog box is displayed.

4. Type a name as desired and type the settings that you configured earlier.
5. Click the **Inputs** tab and select the required inputs.
6. Click  to save the settings.
7. Click  **Events**.
8. Expand , expand **POS Bridge Input**, click **Data Input**.
9. In the **Trigger Alarm** list, select **Always** to ensure that this event always triggers an alarm. If you want the event trigger an alarm only during a certain time span, select a schedule.
10. Click  to save the settings.



11. Click **Alarms**.
12. Configure the desired alarm settings for this event.





13. Click  to save the settings and click  to activate the configuration.
14. Perform a test to ensure that the alarm is working as desired.

25.2 Adding a Bosch Allegiant input alarm

After a Bosch Allegiant device is added to Bosch VMS, you add Allegiant alarm inputs.

1. On the Device Tree, click the Allegiant device entry.
2. Click the **Inputs** tab and click **Add Input**.
3. Add the desired input alarms.
4. Click **Events**.
5. In the Event Tree, expand **Allegiant Devices**, expand **Allegiant Input**, and click **Input Closed** or **Input Opened** (depends on your application).
6. In the **Trigger Alarm** list, select **Always** to ensure that an event always triggers an alarm. If you want the event trigger an alarm only during a certain time span, select a schedule.



7. Click  to save the settings and click  to activate the configuration.
8. Perform a test to ensure that the alarm is working as desired.

25.3 Adding and configuring 2 Dinion IP cameras with VRM recording

This section describes how to add 2 Dinion IP cameras for VRM recording, how to configure different recording settings and how to configure Forensic Search for these cameras.

Prerequisite:

VRM and iSCSI devices are properly configured.

This means:

- The VRM is added to the Device Tree.
- An iSCSI device with configured target and LUN is assigned to this VRM.

To add the IP cameras to an existing VRM:



Main window > **Devices** > Expand



1. Right-click  and click **Add Encoder**. The **Add Encoder** dialog box is displayed.
2. Type the IP address of the IP camera and select the encoder type (Dinion IP). Click **OK**. Repeat this step for the other IP camera.

To add the IP cameras to the Logical Tree:



Main window > **Maps and Structure**



- ▶ Drag the cameras to the Logical Tree.

To change camera properties:

Main window >  **Cameras and Recording** >  >  tab

1. In the **Live Video** column, configure the quality of live display. For these devices, you can only set the live quality per camera, not schedule dependent.
2. Make the appropriate settings in the other columns.

To configure recording settings for the cameras:

1. Click a schedule tab, for example .
2. In the  column, click a cell and select the appropriate stream quality.
3. Under **Continuous or Pre-alarm Recording**, in the **Select** column, select the desired recording mode.
If you click **Pre-alarm**: Click a cell in the **Duration** column to select the alarm recording time before the alarm in seconds.
4. Under **Alarm Recording**, in the **Duration** column, click a cell and type the desired recording time.
5. Repeat the previous steps to configure the recording settings for the other camera.

To enable Forensic Search on a workstation:

Main window >  **Devices** > Expand 



1. Click the  icon of your workstation.
2. Click the **Settings** tab.
3. Click to select the **Enable Forensic Search** check box.

Performing a Forensic Search

Operator Client VRM main window >  >  **Timeline** tab

Perform the Forensic Search on the workstation where you have enabled Forensic Search.

To perform a Forensic Search:

1. Using the Hairline, select the time period on the Timeline and select the corresponding Image pane.
2. Click .
- The **Forensic Search** dialog box is displayed.
The selected time period is copied to the **Start:** and **End:** fields.
If required, change the values. Click .
3. In the **Algorithm:** list, select an entry.
4. In the **Surveillance Tasks** field, configure your Forensic Search.
You can find information on this in the relevant documents on the product CD supplied.
5. Click **Search** to start the Forensic Search.

The  window with the matching entries is displayed.

26 Global Configuration Client windows

This chapter contains information on some basic application windows available in Bosch VMS Configuration Client.

26.1 Configuration window

Main window

Allows you to configure your system. The buttons in the toolbar represent the various pages which you must configure to get a running system. Their sequence represents the recommended workflow of configuration.

- ▶ Click a tree item to display the available property pages.



Devices

Click to display the **Devices** page with all devices connected to the system.



Maps and Structure

Click to display the **Maps and Structure** page with Logical Tree, Device Tree, and maps.



Schedules

Click to display the **Recording Schedules** and **Task Schedules** page.



Cameras and Recording

Click to display the **Cameras and Recording** page with the Camera Table and the recording settings of all cameras.



Events

Click to display the **Events** page.



Alarms

Click to display the **Alarms** page.



User Groups

Click to display the **User Groups** page with all users.



Click to save the changed settings of the current window.



Click to restore the saved settings of the current window.



Click to display the **Activate Configuration** dialog box.



Click to delete the selected item. (Not available on every page).



Click to rename the selected item. (Not available on every page).



Click to display help information on the current window.



Click to refresh the state information for all devices (not available on every page). You can refresh the state of a single device: Right-click the device and click **Refresh state**.

Note: When you have a large system with several 1000 devices configured, the process of refreshing states can take a long time.

26.2

Menu commands

System menu commands		
	Save Changes	Saves all changes made on this page.
	Undo All Changes on Page	Restores the settings of this page since the last saving.
	Activation Manager...	Displays the Activation Manager dialog box.
	Export Configuration...	Displays the Export Configuration File dialog box.
	Import Configuration...	Displays the Import Configuration File dialog box.
	Export Device Information for OPC...	Displays a dialog box for creating a configuration file that you can import in a 3rd party management system.
	Exit	Exits the program.
Hardware menu commands		
	Initial Device Scan...	Displays the Initial Device Scan dialog box.
	Protect Devices with Default Password...	Displays the Protect Devices with Global Default Password dialog box.
	IP Device Configuration...	Displays the IP Device Configuration dialog box.
	Device Monitor...	Displays the Device Monitor dialog box.
	Failover NVR Manager...	Displays a dialog box for re-assigning cameras to a fixed NVR.
Tools menu commands		
	Command Script Editor...	Displays the Command Script Editor dialog box
	Resource Manager...	Displays the Resource Manager dialog box.

	Sequence Builder...	Displays the Sequence Builder dialog box.
	Resource Converter	Displays the Resource Converter dialog box if old map resources in DWF format are available.
	RRAS Configuration...	Displays the RRAS Configuration dialog box.
	License Manager...	Displays the License Manager dialog box.
	License Inspector...	Displays the License Inspector dialog box.

Reports menu commands

	Recording Schedules...	Displays the Recording Schedules report dialog box.
	Task Schedules...	Displays the Task Schedules report dialog box.
	Cameras and Recording Parameters...	Displays the Cameras and Recording Parameters report dialog box.
	Stream Quality Settings...	Displays the Stream Quality Settings report dialog box.
	Event Settings...	Displays the Event Settings report dialog box.
	Compound Event Settings...	Displays the Compound Event Settings report dialog box.
	Alarm Settings...	Displays the Alarm Settings report dialog box.
	Configured Users...	Displays the Configured Users report dialog box.
	User Groups and Accounts...	Displays the User Groups And Accounts report dialog box.
	Operating Permissions...	Displays the Operating Permissions report dialog box.

Settings menu commands

	Alarm Settings...	Displays the Alarm Settings dialog box.
	SNMP Settings...	Displays the SNMP Settings dialog box.
	Set Recording Qualities...	Displays the Stream Quality Settings dialog box.
	Options...	Displays the Options dialog box.
	Remote Access Settings...	Displays the Remote Access Settings dialog box.

Help menu commands

	Display Help	Displays the Bosch VMS Application Help.
	Help	Displays a dialog box containing information on the installed system, e.g., the version number.

26.3 Activation Manager dialog box

Main window > **System** menu > **Activation Manager...** command

Allows you to activate the current configuration or to rollback to a previous configuration.

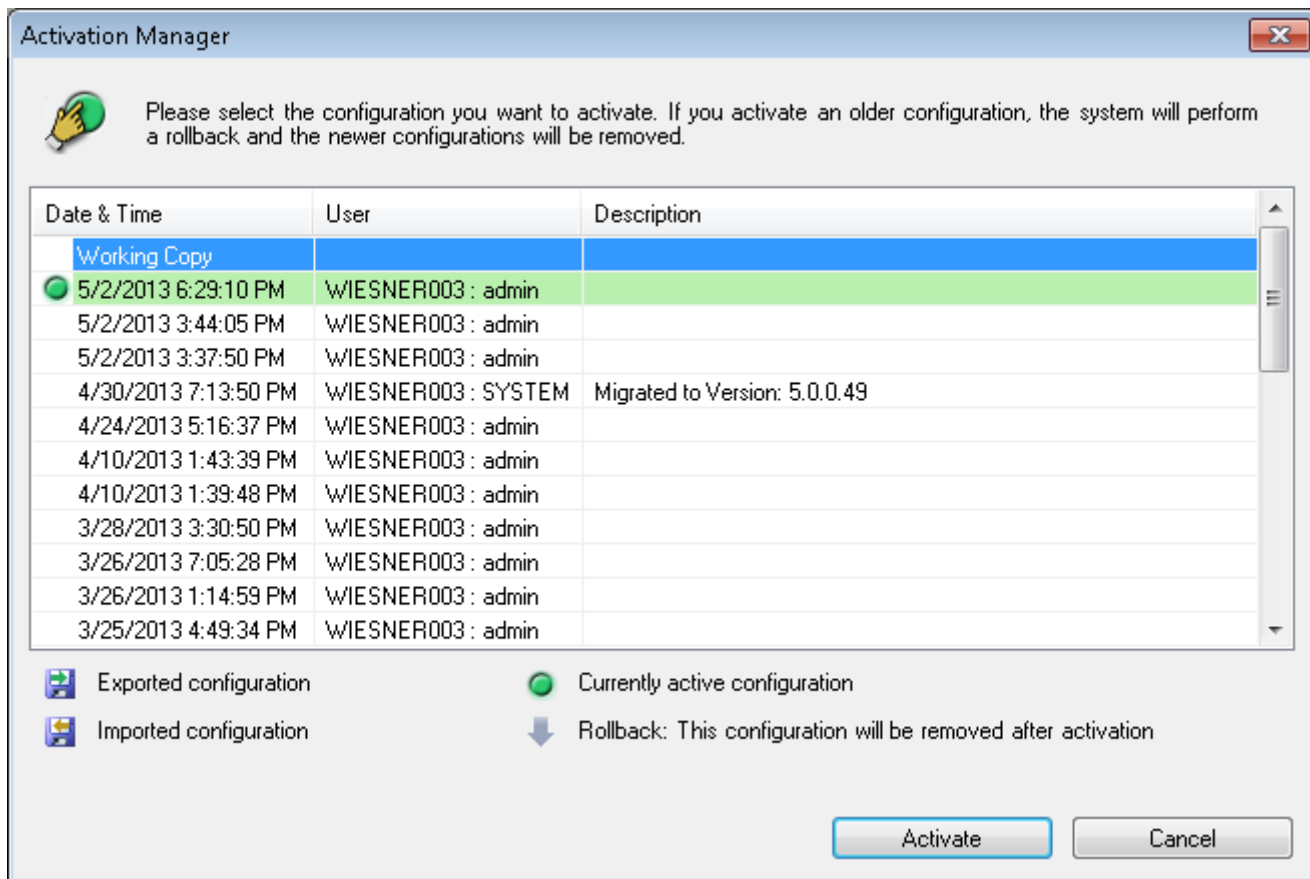
**Activate**

Click to display the **Activate Configuration** dialog box.

See also

- *Activating the working configuration, page 216*
- *Activating a configuration, page 217*

26.4**Activate Configuration dialog box**

Main window >

Allows you to type a description for the working copy of the configuration to be activated.

Set Delayed Activation time

Click to select a delayed activation time.

Force activation for all Operator Clients

If checked, each Operator Client workstation is automatically restarted to activate the new configuration. The user cannot refuse the new configuration.

If not checked, on each Operator Client workstation a dialog box appears for some seconds. The user can refuse or accept the new configuration. The dialog box is closed after a few seconds without user interaction. In this case the new configuration is not accepted.

Configure RRAS service before Activation

Only available if you have enabled the **Enable Port Mapping** option in the **Remote Access Settings** dialog box.

If checked, the **RRAS Configuration** dialog box is displayed before activation is performed.

See also

- *Activating the working configuration, page 216*

26.5**Protect Devices with Global Default Password dialog box**

Main window > **Hardware** menu > **Protect Devices with Default Password...** command
or



Main window >

This dialog box appears, if an activation is pending and if your configuration contains devices that are not protected by a password. It allows you to enter a global default password that is applied on all affected devices.

Refresh States

Click to rescan the network for devices that are not protected by a password.

Global default password

Type in a password that is used for all currently not protected devices.

Show passwords

Click to enable that all passwords in this dialog are visible.

Enforce password protection on activation

Click to select this checkbox. If enabled, you must apply a global default password for devices that are not protected by a password.

Apply

Click to apply the global default password.

The **Changing Passwords** dialog box is displayed. The changes of passwords are listed.

Click **OK** to close.

If you started with activating your configuration, the **Activation Manager** dialog box is displayed.

See also

- *Activating the working configuration, page 216*

26.6**License Manager dialog box**

Main window > **Tools** menu > **License Manager...** command

Allows you to license the Bosch VMS package that you have ordered and to upgrade with additional features.

Base Packages

Displays the available base packages.

Type Number

Displays the Commercial Type Number (CTN) of the selected package, feature or expansion.

Status

Displays the licensing status if applicable.

Optional Features

Displays the available features.

Expansion

Displays the available expansions and their count. To change the count point right from a check box and click the up or down arrow.

Activate

Click to display the **License Activation** dialog box.

Import Bundle Info

Click to import an XML file containing a Bundle Information that you received from Bosch.

Add New Package

Click to display a dialog box for selecting a new license file.

See also

- *Activating the software licenses, page 99*

26.7

License Activation dialog box

Main window > **Tools** menu > **License Manager...** command > **License Manager** dialog box > **Activate** button

Allows you to license the Bosch VMS packages that you have ordered and to upgrade with additional packages.

For obtaining the License Activation Key you must contact the Bosch Activation Center and specify the desired package and the computer signature of the Management Server. Additionally you need the Authorization Number. This number is included in your software box.

License Activation Key:

Allows you to type the License Activation Key received from the Bosch Activation Center.

See also

- *Activating the software licenses, page 99*

26.8

Reports dialog boxes

This chapter covers all dialog boxes which are available for configuration reports.

See also

- *Creating a report, page 219*

26.8.1

Recording Schedules dialog box

Main window > **Reports** menu > **Recording Schedules...** command

Lists the configured recording schedules.

- ▶ Click **CSV Export** to save all information of this dialog box in a CSV file.

26.8.2

Task Schedules dialog box

Main window > **Reports** menu > **Task Schedules...** command

Lists the configured task schedules.

- ▶ Click **CSV Export** to save all information of this dialog box in a CSV file.

26.8.3

Cameras and Recording Parameters dialog box

Main window > **Reports** menu > **Cameras and Recording Parameters...** command

Lists the recording parameters that are configured in the Camera Table and the Recording Table.

- ▶ Click **CSV Export** to save all information of this dialog box in a CSV file.

26.8.4

Stream Quality Settings dialog box

Main window > **Reports** menu > **Stream Quality Settings...** command

Lists the configured stream quality settings of all cameras.

- ▶ Click **CSV Export** to save all information of this dialog box in a CSV file.

26.8.5 Event Settings dialog box

Main window > **Reports** menu > **Event Settings...** command

Lists the events for which a schedule for triggering an alarm is configured.

- ▶ Click **CSV Export** to save all information of this dialog box in a CSV file.

26.8.6 Compound Event Settings dialog box

Main window > **Reports** menu > **Compound Event Settings...** command

Lists the all compound events.

- ▶ Click **CSV Export** to save all information of this dialog box in a CSV file.

26.8.7 Alarm Settings dialog box

Main window > **Reports** menu > **Alarm Settings...** command

Lists all alarm settings of the configured alarms, including the settings in the **Alarm Options** dialog box.

- ▶ Click **CSV Export** to save all information of this dialog box in a CSV file.

26.8.8 Configured Users dialog box

Main window > **Reports** menu > **Configured Users...** command

Lists the users who are permitted to log on to the system.

- ▶ Click **CSV Export** to save all information of this dialog box in a CSV file.

26.8.9 User Groups and Accounts dialog box

Main window > **Reports** menu > **User Groups and Accounts...** command

Lists the configured user groups and dual authorization groups.

- ▶ Click **CSV Export** to save all information of this dialog box in a CSV file.

26.8.10 Device Permissions dialog box

Main window > **Reports** menu > **Device Permissions...** command

Lists the permissions for using the configured devices for each user group.

- ▶ Click **CSV Export** to save all information of this dialog box in a CSV file.

26.8.11 Operating Permissions dialog box

Main window > **Reports** menu > **Operating Permissions...** command

Lists the permissions for using Operator Client for each user group.

- ▶ Click **CSV Export** to save all information of this dialog box in a CSV file.

26.9 Alarm Settings dialog box

See *Alarm Settings dialog box*, page 365 for details.

26.10 Options dialog box

Main window > **Settings** menu > **Options...** command

Language

Allows you to configure the language of your Configuration Client. If you select **System language** the language of your Windows installation is used.

This setting is enabled after restarting Configuration Client.

Analog Monitor Group (AMG) Settings

Allows you to configure that the users can control all analog monitor groups with each Bosch VMS client computer. It is then not required to configure this computer as a workstation in the Device Tree.

This setting is enabled after activating the configuration.

Decoders automatically select the stream when connecting to camera

Allows you to configure that all decoders in your system use a compatible stream and not necessarily the Live stream.

This setting is enabled after activating the configuration.

Logbook Configuration

Allows you to configure the connection string for the Logbook database. Change this string only when you want to configure a remote SQL server for the Logbook and only when you are familiar with SQL server technology.

This setting is enabled after activating the configuration.

Enable advanced state display (hot spot coloring in maps depending on state)

Allows you to configure for all state events that the hot spots of the devices belonging to this event, are displayed with a background color and blink when the configured event occurs.

The configuration of the advanced state display is possible after you saved the configuration.

The hot spots are displayed on a map in Operator Client after you have activated the configuration.

Enforce automatic logoff of Configuration Client after this time of inactivity

This setting is enabled after activating the configuration.

Allow multiple logons with the same user name

Allows you to configure that a user of Bosch VMS SDK, Bosch VMS Web Client, Bosch VMS Mobile App, or Operator Client can perform multiple synchronous logons with the same user name.

See also

- *Assigning an analog monitor group to a workstation, page 163*

26.11**Remote Access Settings dialog box**

Main window > **Settings** menu > **Remote Access Settings...** command

Allows you to configure the port mapping for remote access.

You add one or more port ranges. Bosch VMS automatically assigns each private IP address of a configured device to a different public port number of one these ranges.

In the router that connects your private network with the public network, you configure the same port mapping. The router then forwards each packet with public port number from the public network to the private IP address and port number. Private IP address and port number have been configured in the port mapping table for this public port number.

**Notice!**

Additionally in the router you must manually configure the port forwarding according to the settings in the port mapping table.

Enable Port Mapping

Click to enable / disable port mapping.

Add

Click to add a port range in the **Port Ranges** list.

Edit

Click to change a selected entry in the **Port Ranges** list.

Remove

Click to remove a selected entry in the **Port Ranges** list.

Private IP address (for access within the LAN)

Select the private IP address of your Management Server local network adapter.

Public network address (IP address or DNS name, for access from external, e.g. via Internet)

Type in the public network address of this private network. The remote Operator Client logs on with this public network address to get access to the devices of this Management Server.

Show Port Mapping...

Click to display the **Port Mapping Table** dialog box.

See also

– *Remote access, page 35*

26.11.1**Port Mapping Table dialog box**

Main window > **Settings** menu > **Remote Access Settings...** command > **Show Port Mapping...** button > **Port Mapping Table** dialog box

Displays the port mapping for the IP addresses of the configured devices in your Bosch VMS. You can copy the table into the clipboard and you can add entries that are not managed by Bosch VMS.

Copy to Clipboard

Click to copy the mapping table to the clipboard. This helps you in creating a configuration script for a port mapping in a router (for example a RRAS service).

Protocol

Displays the used network protocol for this device.

You can change the value manually.

Private Port

Displays the private port number used in the private network for this device.

You can change the value manually.

Public Port

Displays the public port number used by Operator Client from public networks to access this device.

You can change the value manually.

Fixed

Click to check to fix the manually assigned port number.

Click to uncheck to enable the automatic assignment of a port number.

26.12**Device Monitor dialog box**

Main window > **Hardware** menu > **Device Monitor...** command > **Device Monitor** dialog box

Allows you to check the status of the encoders/decoders in your Device Tree that are active in your Bosch VMS.

Display Name

Device name that was configured in Bosch VMS.

Network Address

IP address of the device.

State

The following states can be displayed:

- **Configured:** Configuration of this device is activated.
- **Configuration mismatch:** Configuration of this device is not activated.

- **Unknown:** Status could not be determined.
- **Not Connected:** Not connected.

Last Check

Date and time when the dialog was started and the check was performed. As long as the dialog box is displayed, the devices are not checked again.

See also

- *Checking the status of your encoders/decoders, page 219*

26.13

SNMP Settings dialog box

Main window > **Settings** menu > **SNMP Settings...** command

Allows you to configure SNMP monitoring on your Management Server computer. You specify for which event an SNMP trap is sent, some additional information on your system, and the IP addresses of the computers which are planned to receive SNMP traps from Bosch VMS.

The server sends SNMP traps when events occur. You can receive these traps with the SNMP receiver in Configuration Client using the **SNMP Trap Logger** tool. You can also use another software that can receive SNMP traps.

The SNMP agent in Bosch VMS supports SNMP GetRequest. When an SNMP manager software (for example iReasoning MIB Browser) sends an SNMP GetRequest to the Bosch VMS Management Server then the Management Server sends a corresponding response message. The MIB file is located in the following file:

```
<installation_directory>\Bosch\VMS\bin\BVMS.mib
```

Only SNMPv1 and v2 are supported.

Note: SNMPv1 and SNMPv2 are not completely compatible. Hence we recommend not using SNMPv1 and SNMPv2 together.

SNMP GET port

Type in the port number for SNMP GetRequest. This is the port where the SNMP agent of the Bosch VMS Management Server listens for SNMP GetRequest.

Note: Bosch VMS does not use the standard port number 161 for SNMP GetRequest, because this port is possibly used by the SNMP agent of the computer where the Bosch VMS Management Server is installed on.

The default value is 12544.

System contact

Type in contact data for your Bosch VMS. You can retrieve this information with an SNMP GetRequest using the OID .1.3.6.1.2.1.1.4.

System description

Type in a description of your Bosch VMS. You can retrieve this information with an SNMP GetRequest using the OID .1.3.6.1.2.1.1.5.

System location

Type in the location of your Bosch VMS. This string should specify the physical location of the server computer, for example building, room number, rack-number, etc.

You can retrieve this information with an SNMP GetRequest using the OID .1.3.6.1.2.1.1.6.

Trap Receivers

Type the IP address of the computer where Bosch VMS is supposed to send SNMP traps to.

Trap Filter

Click to select the events in the Event Tree to filter the SNMP traps that are sent.

See also

- *Configuring SNMP monitoring, page 219*

26.14**License Investigator dialog box**

Main window > **Tools** menu > **License Inspector...** command > **License Inspector** dialog box

You can check whether the number of installed Bosch VMS licenses exceeds the number of purchased licenses.

27 Devices page



Main window > **Devices**

Displays the Device Tree and the configuration pages.

The count of items below an entry is displayed in square brackets.

Allows you to configure the available devices, such as mobile video services, ONVIF encoders, Bosch Video Streaming Gateway devices, encoders, decoders, VRMs, local storage encoders, analog matrices, or peripheral devices like ATM / POS bridges.

Note:

Video data from encoders that are assigned to an NVR, is always encoded with MPEG-4.

Devices are represented in a tree and grouped by the physical network structure and the device categories.

Video sources like encoders are grouped under VRMs. Digital video recorders such as DiBos are listed separately.

Scans the network for NVRs, decoders, and encoders. When the scan process is finished, a dialog box for assigning the detected encoders to NVRs is displayed.



Failover NVR Manager

Click to display the **Failover NVR Manager** dialog box.



IP Device Configuration

Click to display the **IP Device Configuration** dialog box.



Type in a string and press the ENTER key to filter the displayed items. Only items containing the string and their corresponding parent items (only in trees) are displayed. The count of filtered items and the total count of items is provided. An active filter is indicated by . Enclose strings with double quotes to find them exactly, for example "Camera 1" exactly filters the cameras with this name, not camera 201.

To cancel filtering, click .

- ▶ Click a tree item to display the corresponding page.

27.1 Server List / Address Book page



Main window > **Devices > Enterprise System > Server List / Address Book**



Main window > **Devices > Enterprise System > Server List / Address Book**

You can add multiple Management Server computers for simultaneous access in Bosch VMS Enterprise System. You can also add multiple Management Server computers for sequential access for Server Lookup.

You can add additional columns in the Server List. This lets you add further information that the user can search for when using Server Lookup. The added columns are also visible on the

 **Server Access** page (Main window >  > **Server Access** tab).

User Groups > Enterprise User Group tab >

Add Server

Click to display the **Add Server** dialog box.

Delete Server

Click to remove the Management Server entries.

Management Server

Displays the names of all added Management Server computers. You can change each entry.

Private Network Address

Displays the private network addresses of all added Management Server computers. You can change each entry.

Public Network Address

Displays the public network addresses of all added Management Server computers. You can change each entry. You need the public network address for accessing this Management Server computer via remote access.

Server Number

Displays the logical numbers of all added Management Server computers. You can change each entry.

Server Description

Type in a description for this Management Server. You need this description to find it in the list of all available servers when you want to access the Management Server exclusively, for example to clarify an alarm coming from another management system.

Click to get a step-by-step instruction:

- *Configuring the Server List for Enterprise System, page 119*
- *Configuring Server Lookup, page 121*
- *Exporting the Server List, page 122*
- *Importing a Server List, page 122*

27.1.1

Add Server dialog box



Main window >  **Devices > Enterprise System > Server List / Address Book**

Server name

Type in the display name of the Management Server.

Private network address

Type in the private IP address or DNS name of the Management Server.

Public network address

Type in the public network address or DNS name used for routed access.

Server description

Type in a description for the Management Server.

27.2 Initial Device Scan dialog box

Main window > **Hardware** menu > **Initial Device Scan...** command

Displays the devices which have duplicate IP addresses or a default IP address (192.168.0.1).

Allows you to change such IP addresses and subnet masks.

You must enter the correct subnet mask before changing an IP address.

27.3 NVR & Decoder Scan dialog box

As of Bosch VMS 5.0, NVRs, Failover NVRs, and Redundant NVRs are not supported any longer.



Main window > **Devices** > **NVR & Decoder Scan**

Displays detected encoders, NVRs, and decoders.

Allows you to assign detected encoders to an NVR. This is required to store the video data of the encoder on an NVR and to manage events of their assigned devices.

Unassigned devices do not appear in the Device Tree.



Notice!

Only devices in the local subnet are detected automatically. If a device is located in another subnet, add it manually to the Device Tree. To perform this, right-click the required node (for example an NVR), click **Add Encoder**, type the IP address of the device, click the **Network** tab and enter the subnet mask of the device.

Unassigned Encoders

Displays the unassigned encoders that were detected.

Assigned Encoders and NVRs

Displays assigned encoders and NVRs. NVRs are automatically assigned when they are detected. For assigning encoders you must drag them from the **Unassigned Encoders** list to an NVR.

Decoders

Displays the detected decoders.

Configure Devices

Click to display the **IP Device Configuration** dialog box.

Next >

Click to display the next page of this dialog box. If the device names differ from their names in Bosch VMS, a dialog box is displayed for changing the names as required.

Finish

Click to confirm the scan results and the assignments of encoders and close the dialog box.

27.4 IP Device Configuration dialog box



Main window > **Devices** >

Displays the following properties of the available IP devices:

- Device name and type
- Connection type (BVIP or ONVIF)
- IP address
- Subnet mask
- System password

- Firmware version
- Gateway IP address

Allows you to set the following properties of the available IP devices:

- Display name
- IP address
- Firmware version

You can configure display names, IP addresses and firmware versions for multiple devices at once.



Click to refresh the state information for all devices (not available on every page). You can refresh the state of a single device: Right-click the device and click **Refresh state**.

Note: When you have a large system with several 1000 devices configured, the process of refreshing states can take a long time.

Update Firmware

Click to update the firmware version of the selected device.

Show passwords

Click to clear when you want the configured passwords being displayed in readable form.



Type in a string and press the ENTER key to filter the displayed items. Only items containing the string and their corresponding parent items (only in trees) are displayed. The count of filtered items and the total count of items is provided. An active filter is indicated by . Enclose strings with double quotes to find them exactly, for example "Camera 1" exactly filters the cameras with this name, not camera 201.

To cancel filtering, click .

Apply

Click to configure the devices with the entered values without closing the dialog box.

See also

- *Configuring multiple encoders / decoders, page 140*

27.5

Set IP Addresses dialog box



Main window > **Devices** > **IP Device Configuration** dialog box > Right-click two or more entries > Click **Set IP Addresses...**

Allows you to set the IP addresses for multiple IP devices.

Start with:

Type the first IP address.

End with:

Displays the last IP address for the selected devices after having clicked **Calculate**.

Calculate

Click to calculate the range of IP addresses for the selected devices.

See also

- *Configuring multiple encoders / decoders, page 140*

27.6 Set Display Names dialog box



Main window >  **Devices** >  > **IP Device Configuration** dialog box > Right-click two or more entries > Click **Set Display Names...**

Allows you to set the display names for multiple IP devices.

Start with:

Type the first name.

End with:

Displays the last name for the selected devices after having clicked **Calculate**.

Calculate

Click to calculate the range of display names for the selected devices.

See also

– *Configuring multiple encoders / decoders, page 140*

27.7 NVRs / Failover NVRs / Redundant NVRs page

As of Bosch VMS 5.0, NVRs, Failover NVRs, and Redundant NVRs are not supported any longer.

27.8 Vidos NVRs page



Main window >  **Devices** > Expand  > Expand  > 

Allows you to add and configure VIDOS NVRs.

You cannot configure VIDOS systems from within Bosch VMS.

Network address

Type the DNS name or the IP address of your VIDOS NVR.

User Name:

Type the user name for logging on to the VIDOS NVR.

Password:

Type the password for logging on to the VIDOS NVR.

See also

– *Scanning for devices, page 83*

27.9 DiBos page



Main window >  **Devices** > 

Displays the property pages of a selected DiBos system.

Allows you to integrate a DiBos system into your system.



Notice!

You do not configure the DiBos system itself but only the Bosch VMS related properties.



► Click a tab to display the corresponding property page.

See also

- *Adding a device manually, page 155*
- *Configuring the integration of a DiBos system, page 160*

27.9.1 Add DiBos System dialog box



Main window >  **Devices** > Right-click  > **Add BRS/DiBos System** command
Allows you to add a DiBos system to your Bosch VMS.

Network address

Type the DNS name or the IP address of your DiBos system.

User name:

Type the user name for logging on to the DiBos system.

Password:



Type the password for logging on to the DiBos system.

See also

- *Adding a device manually, page 155*

27.9.2 Settings page



Main window >  **Devices** > Expand  >  > **Settings** tab



Displays the network settings of the DiBos system connected to your system. Allows you to change the settings if required.

See also

- *Configuring the integration of a DiBos system, page 160*

27.9.3 Cameras page



Main window >  **Devices** > Expand  >  > **Cameras** tab

Displays all cameras available on the DiBos system connected to your system. Allows you to remove cameras.

See also

- *Configuring the integration of a DiBos system, page 160*

27.9.4 Inputs page



Main window >  **Devices** > Expand  >  > **Inputs** tab



Displays all inputs available on the DiBos system connected to your system. Allows you to remove items.

See also

- *Configuring the integration of a DiBos system, page 160*

27.9.5 Relays page



Main window >  **Devices** > Expand  >  > **Relays** tab
 Displays all relays available on the DiBos system connected to your system.
 Allows you to remove items.

See also

- *Configuring the integration of a DiBos system, page 160*

27.10 DVR (Digital Video Recorder) page



Main window >  **Devices** >  > 
 Displays the property pages of a selected DVR.
 Allows you to integrate a DVR into your system.

- ▶ Click a tab to display the corresponding property page.



Notice!

You do not configure the DVR itself but only the integration of the DVR device into Bosch VMS.



Caution!



Add the DVR using the administrator account of the device. Using a DVR user account with restricted permissions can result in features that are not usable in Bosch VMS, for example using the control of a PTZ camera.

See also

- *DVR devices, page 53*
- *Configuring the integration of a DVR, page 161*

27.10.1 Add DVR dialog box



Main window >  **Devices** > Expand  >  > **Add DVR Recorder**
 Allows you to manually add a DVR device.

Network address:

Type the DNS name or the IP address of your DVR.

User name:

Type the user name for connecting to the DVR.

Password:

Type the password for connecting to the DVR.

Click below to get step-by-step instructions:

- *Adding a device manually, page 155*

27.10.2 Settings tab

Main window > **Devices** >  >  > **Settings** tab

Displays the network settings of the DVR connected to your system. Allows you to change the settings if required.

27.10.3 Cameras tab

Main window > **Devices** >  > **Cameras** tab

Displays all video channels of the DVR as cameras. Allows you to remove cameras.

A video input that is disabled in a DVR device is displayed as an active camera in Bosch VMS because earlier recordings could exist for this input.

27.10.4 Inputs tab

Main window > **Devices** >  > **Inputs** tab

Displays all inputs of the DVR.

Allows you to remove items.

27.10.5 Relays tab

Main window > **Devices** >  > **Relays** tab

Displays all relays of the DVR. Allows you to remove items.

27.11 Matrix Switches page

Main window >  **Devices** >  > 

Displays the property pages of the Bosch Allegiant device.

You do not configure the Bosch Allegiant device itself but only the Bosch VMS related properties. For connecting an Allegiant device with Bosch VMS, see the **Concepts** chapter in this Online Help. This chapter provides background information on selected issues.

You can additionally configure control priorities for Allegiant trunk lines.

- ▶ Click a tab to display the corresponding property page.

See also

- *Adding a device manually, page 155*
- *Configuring a Bosch Allegiant device, page 162*
- *Connecting Bosch Allegiant Matrix to Bosch Video Management System, page 76*

27.11.1 Connection page

Main window >  **Devices** > Expand  >  > **Connection** tab

Displays the name of the Bosch Allegiant configuration file.

Bosch VMS can read out a configuration file in structured storage format with the names and configuration information of all cameras connected to the Bosch Allegiant device.

Update Configuration

Click to select an updated Bosch Allegiant configuration file.

See also

- *Configuring a Bosch Allegiant device, page 162*

27.11.2 Cameras page



Main window >  **Devices** > Expand  >  > **Cameras** tab

Displays a camera table of the cameras that are connected to the Bosch Allegiant device.

No.

Displays the consecutive number of the camera.

Allegiant Logical No.

Displays the logical number of the camera.

Camera Name



Displays the name of the camera.

See also

- *Configuring a Bosch Allegiant device, page 162*

27.11.3 Outputs page



Main window >  **Devices** > Expand  >  > **Outputs** tab

Allows you to configure the usage of a Bosch Allegiant device output and to assign an encoder to an output.

To store the video data of a Bosch Allegiant device output in Bosch VMS, you must assign an encoder to the output. This encoder must be connected to the output.

No.

Displays the number of the output.

Allegiant Logical No.

Displays the logical number of the output within Allegiant.

Bosch VMS Logical No.

Allows you to change the logical number of the output within Bosch VMS. If you enter an already used number, a message is displayed.

Name

Displays the name of the output.

Usage

Allows you to change the usage of the output.

If you select **Digital Trunk**, you can assign an encoder to this output in the **Encoder** field. The Allegiant output becomes network-compatible.

If you select **Allegiant Monitor**, in Operator Client the user can assign the camera signal to a hardware monitor. PTZ control is possible if the camera is configured as PTZ camera. In Operator Client, the user cannot drag this camera on an Image pane.

If you select **Unused**, the user cannot assign a monitor to an Allegiant camera.

Encoder

Allows you to assign an output to an encoder. You can only select an encoder when you have checked **Digital Trunk**. The encoder is locked for the Logical Tree. If you assign an encoder that is already in the Logical Tree, it is removed from there. In the Operator Client, the user can drag the camera to an Image pane.

See also

- *Configuring a Bosch Allegiant device, page 162*

27.11.4

Inputs page



Main window > **Devices** > Expand > **Inputs** tab
Allows you to add inputs to a Bosch Allegiant device.

Add Input

Click to add a new row in the table for specifying a new input.

Delete Input

Click to remove a row from the table.

Input No.

Type the required number of the input. If you enter an already used number, a message is displayed.

Input Name

Type the required name of the input.

See also

- *Configuring a Bosch Allegiant device, page 162*

27.12

Workstation page

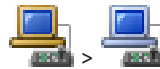



Main window > **Devices** > Expand > **Workstation** tab
Allows you to configure the following settings for a workstation:

- Add a CCTV keyboard connected to a Bosch Video Management System workstation.
- Assign a Command Script that is executed on startup of the workstation.
- Select the default stream for live display.
- Enable Forensic Search.
- Assign analog monitor groups to a workstation.

A workstation must have the Operator Client software installed.

To add a Bosch IntuiKey keyboard that is connected to a decoder, expand , click .

To assign an analog monitor group, configure such a group in  >  > .

See also

- *Adding a device manually, page 155*
- *Configuring a startup Command Script, page 207*
- *Configuring an analog monitor group, page 163*

27.12.1

Settings page



Main window > **Devices** > Expand > **Settings** tab
Allows you to configure a script that is executed when the Operator Client on the workstation is started.

Allows you to configure TCP or UDP as transmission protocol used for all cameras that are displayed in Live Mode on your workstation.

Allows you to configure which stream of an IP device is used for live display.

Allows you to enable Forensic Search for this workstation.

And you can configure the keyboard that is connected to this workstation.

Network address:

Type the DNS name or the IP address of your workstation.

Startup script:

Select the desired script that you want to be started when the workstation's Operator Client is started. You create or import such a script on the **Events** page.

Default camera protocol:

Select the default transmission protocol used for all cameras that are assigned to the Logical Tree of this workstation.

Override settings from "Cameras and Recording" page

Select the check box to enable selecting the desired stream for live view.

Note: For DVR devices which offer more than 1 stream (for example DIVAR AN 3000/5000), the Live stream setting from this DVR is also changed here. Live stream settings for DVR devices are not available on the **Cameras and Recording** page.

Live Stream

Select the desired stream for live view.

When you select **Image pane size optimized**, the resolution of each displayed camera is automatically adjusted to the size of the Image pane depending on the resolution of the used monitor. This is useful for displaying multiple cameras with a large resolution, for example 4K ultra HD cameras. Only cameras with streams whose resolution can be configured independently, can adjust the resolution to the Image pane. The user of Operator Client can change the stream selection for each camera individually.

Use transcoded stream instead, if available

Select the check box to enable the usage of a transcoded stream if available. This transcoded stream is used instead of the selected stream for live view.

For a transcoded stream being available in Bosch VMS, either MVS must be installed or your VRM computer offers a built-in hardware transcoder.

When a camera is displayed in Live Mode then the default stream set for the workstation is used. If the camera has no stream 2 or the transcoding service (SW and HW) is not available then stream 1 will be used even though another setting is configured in the workstation settings.

Enable Forensic Search

Click to enable Forensic Search for this workstation.

Use direct playback from storage

Select the check box to send the video stream directly from the storage device to this workstation. Now the stream is not sent via VRM. The workstation still needs connection to the VRM to ensure correct playback.

Retrieve live video from Video Streaming Gateway instead of camera

Displays the list of Video Streaming Gateway devices. Select the desired entries to enable the transmission of video data via low bandwidth segments between the video source and this workstation.

Keyboard type:

Select the type of the keyboard that is connected to your workstation.

Port

Select the COM port that is used to connect your keyboard.

Baudrate:

Select the maximum rate, in bits per second (bps), that you want data to be transmitted through this port. Usually, this is set to the maximum rate supported by the computer or device you are communicating with.

Data bits:

Displays the number of data bits you want to use for each character that is transmitted and received.

Stop bits:

Displays the time between each character being transmitted (where time is measured in bits).

Parity:

Displays the type of error checking you want to use for the selected port.

Port type:

Displays the connection type that is used to connect the Bosch IntuiKey keyboard with the workstation.

See also



- *Configuring a startup Command Script, page 207*
- *Enabling Forensic Search on a workstation, page 163*

27.12.2

Assigned Analog Monitor Groups page

Main window >  **Devices** > Expand  >  > **Assigned Analog Monitor Groups** tab

Allows you to assign an analog monitor group to this workstation. Beforehand you must have

added an analog monitor group in  >  > .

Assigned Analog Monitor Groups

Select the check box to assign the analog monitor group to this workstation. In the **Options** dialog box, you can configure that all other workstations can also control analog monitor groups.

Analog Monitor Group

Displays the name of each analog monitor group.

See also

- *Assigning an analog monitor group to a workstation, page 163*

27.13

Decoders page

Main window >  **Devices** > Expand  > 

Allows you to add and configure decoders.

See *Bosch Encoder / Decoder page, page 290* for details.





**Notice!**

If you want to use decoders in your system, make sure that all encoders use the same password for the user authorization level.

See also

– *Scanning for devices, page 83*

27.13.1**Add Encoder / Add Decoder dialog box**

 Main window >  **Devices** > Expand  > Expand  > Right-click  > Click **Add Encoder** > **Add Encoder** dialog box
 or

 Main window >  **Devices** > Right-click  > Click **Add Encoder** > **Add Encoder** dialog box
 or

 Main window >  **Devices** > Right-click  > Click **Add Encoder** > **Add Encoder** dialog box
 or

 Main window >  **Devices** > Expand  > Expand  > Right-click  > Click **Add Encoder** > **Add Encoder** dialog box
 or

 Main window >  **Devices** > Expand  > Right-click  > Click **Add Decoder** > **Add Decoder** dialog box

Allows you to add an encoder or decoder manually. This is especially useful when you want to add any Video IP device from Bosch (only for VRM).

IP address:

Type in a valid IP address.

Encoder type: / Decoder type:

For a device with known device type, select the appropriate entry. It is not necessary that the device is available in the network.

If you want to add any Video IP device from Bosch, select **<Auto Detect>**. The device must be available in the network.

See also



– *Adding a device manually, page 155*

27.13.2 Edit Encoder / Edit Decoder dialog box

Main window >  **Devices** > Expand  > Expand  > Right-click  > Click **Edit Encoder** > **Edit Encoder** dialog box
or

Main window >  **Devices** > Right-click  > Click **Edit Encoder** > **Edit Encoder** dialog box
or

Main window >  **Devices** > Right-click  > Click **Edit Encoder** > **Edit Encoder** dialog box
or

Main window >  **Devices** > Expand  > Expand  > Right-click  > Click **Edit Encoder** > **Edit Encoder** dialog box
or

Main window >  **Devices** > Expand  > Right-click  > Click **Edit Decoder** > **Edit Decoder** dialog box

Edit Encoder

Device Identification

Name: DINION IP starlight 6000/7000 H

Network address: 172.31.23.145

Credentials

User name: service

Password: *****

Show password

Security

Secure connection (encryption)

Device Capabilities

Device properties	
Device type	DINION IP starlight 6000/7000 HD
Audio	True
PTZ	False
Device family	Device Family 3
Encoder platform	CPP6/7 HD
Interfaces	
Number of video input channels	1
Number of alarm inputs	2
Number of relays	1
Number of serial ports	1
Number of audio input channels	1

Allows you to check and update the device capabilities of a device. On opening this dialog box the device is connected. The password is checked and the device capabilities of this device are compared with the device capabilities stored in Bosch VMS.

Name

Displays the device name. When you add a Video IP device from Bosch, the device name is generated. If required change the entry.

Network address

Type in the network address of the device.

User name

Displays the user name used for authenticating at the device.

Password

Type in the valid password for authenticating at the device.

Show password

Click to enable that the entered password is displayed. Be careful that nobody can spy out this password.

Authenticate

Click to authenticate at the device with the credentials entered above.

Secure connection (encryption)

You can activate the encryption of live video transferred from an encoder to the following devices if HTTPS port 443 is configured on the encoder:

- Operator Client computer
- Management Server computer
- Configuration Client computer
- VRM computer
- Decoder

Note:

When activated, the user of Operator Client cannot switch a stream to UDP and to UDP multicast.

When activated, ANR does not work for the affected device.

When activated, encoder replay does not work on encoders with firmware earlier than 6.30.

Device Capabilities

You can sort the displayed device capabilities per category or alphabetically.

A message text informs you whether the detected device capabilities match the current device capabilities. Click **OK** to apply the changes of the device capabilities after an upgrade of the device.

See also

- *Encrypting live video, page 145*
- *Updating the device capabilities, page 138*

27.13.3

Enter password dialog box

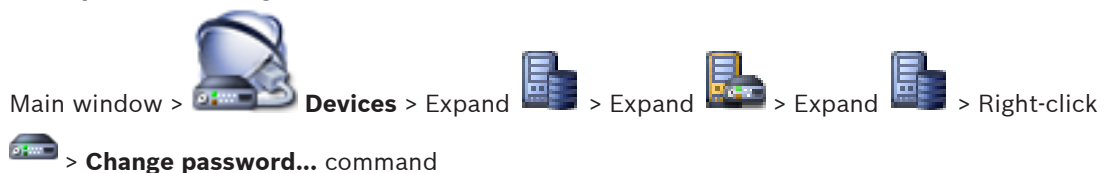

A password prevents unauthorized access to the device. You can use different authorization levels to limit access.

Proper password protection is only guaranteed when all higher authorization levels are also protected with a password. Therefore, you always have to start from the highest authorization level when assigning passwords.

You can define and change a password for each authorization level if you are logged in as service or if the unit is not password protected.

Enter the password for the appropriate authorization level here. The maximum password text length is 19 characters and no special characters are allowed.

The device has three authorization levels: service, user, and live.

- service is the highest authorization level. Entering the correct password gives access to all the functions and allows all configuration settings to be changed.
- user is the middle authorization level. At this level you can operate the device, play back recordings, and also control camera, for example, but you cannot change the configuration.
- live is the lowest authorization level. At this level you can only view the live video image and switch between the different live image displays.

For a decoder the following authorization level replaces the live authorization level:

- destination password (only available for decoders)
Used for access to an encoder.

See also

- *Changing the password of an encoder / decoder, page 140*
- *Providing the destination password for a decoder, page 141*

27.14 Analog Monitor Groups page

Main window >  **Devices** > Expand  > 
 Allows you to add and configure analog monitor groups. You assign an analog monitor group to a Bosch VMS workstation in .

Caution!

You cannot control an analog monitor group from within Operator Client when the connection to the Management Server is lost or when Operator Client with Enterprise System is used.

See also

- *Adding a device manually, page 155*
- *Configuring an analog monitor group, page 163*

27.14.1 Settings page

Main window >  **Devices** > Expand  >  > **Settings** tab

Allows you to perform the following tasks:

- Configure an analog monitor group
- Assign decoders to an analog monitor group

- Enable quad view for decoders that support quad view

Name:

Type the name of the analog monitor group.

Columns:

Enter the number of columns for the analog monitor group. The result is displayed.

Rows:

Enter the number of rows for the analog monitor group. The result is displayed.

Unassigned decoder channels

Drag a decoder to an available analog monitor.

Monitor image

The white number, if present, displays the logical number of the initial camera. The black number displays the logical number of the decoder.

Right-click an analog monitor image to toggle between single view and quad view. On the **Advanced Configuration** page, the **Quad View** column displays the corresponding setting. To un-assign a decoder, right-click the analog monitor image and click **Clear Monitor**.

See also

- *Configuring an analog monitor group, page 163*

27.14.2**Advanced Configuration page**

Main window >  **Devices** > Expand  >  > **Advanced Configuration** tab

Allows you to perform the following tasks:

- Configure the logical number of a decoder or decoder channel.
- Enable quad view for decoders that support quad view
- Configure the OSD.

**Notice!**

We do not recommend configuring quad view for H.264 cameras.

Note the following hints on switching the decoder between quad view and single view in the Operator Client:

- The user can manually switch the decoder back to single view when it is configured as quad view.
- When the decoder is switched to single view or to quad view and a sequence is just running, only the last video stream remains visible.
- When the user switches to quad view, the last cameras that have been displayed on Image pane 2-4 are reconnected.
- This is also valid for trunk lines. There is only one limitation: If the matrix camera cannot be reconnected, this is ignored without an error message. A black Image pane is visible.
- When switching to single view, all trunk lines that are displayed on Image pane 2-4 are disconnected. Only the camera number is stored for a later switch to quad view.

Decoder Name

Displays the display name of the decoder.

Network Address

Displays the IP address of the decoder.

Logical Number

Enter the logical number of the decoder. If you enter an already used number, a message is displayed.

Quad

Displays the position of the decoder on the quad view. 1 is left upper corner, 4 is right lower corner.

Quad View

Select the check box to enable quad view for this decoder. On the **Settings** page, the corresponding analog monitor image displays the quad view. Logical numbers are created automatically. If you want the Operator Client user to be able to switch between quad view and single view, then check **Quad View**. If you clear **Quad View**, the Operator Client user cannot switch.

AMG

Displays the analog monitor group that the decoder in this row is assigned to.

Initial Camera

Click to select the camera that is displayed initially on the monitor after having started the Operator Client. The logical number of the initial camera is displayed as the white number on the monitor image in the **Settings** page.

OSD Camera Name

Check to display the camera name as OSD.

OSD Camera No.

Check to display the logical number of the camera as OSD.

OSD Position

To set the location of an OSD, select the desired entry.

See also

– *Configuring an analog monitor group, page 163*

27.15**Monitor Wall page**

Main window > **Devices** >

Allows you to add a monitor wall application. This application allows for controlling the monitor wall hardware from within Operator Client. No server is involved in controlling the monitor wall. This ensures that the user of Operator Client is always able to control the monitor wall even if the Management Server is offline.

Name

Type in a display name for your monitor wall.

Monitor

Select a monitor that is connected to a decoder.

If you add a decoder that has 2 monitors connected, you must display the **Edit Decoder** dialog box of the decoder and update the device capabilities of this decoder. For each monitor add a further monitor wall.

Maximum number of cameras to connect

Type in the maximum number of cameras that are allowed to be displayed in the monitor wall. If you leave the field empty, the operator can display as many cameras as Image panes on the monitor wall layout are available.

Enable thumbnails

Click to check if you want to display a snapshot in Operator Client for each monitor. This snapshot is regularly updated.

Initial sequence

Select a camera sequence for initial display on the monitor wall when the operator starts this monitor wall.



Notice!

When you delete a sequence in the **Sequence Builder** dialog box, this sequence is automatically removed from the **Initial sequence** list of a monitor wall if configured there.

See also

- *Sequence Builder dialog box, page 344*
- *Adding a monitor wall, page 164*
- *Adding a monitor wall, page 164*

27.15.1

Add Monitor Wall dialog box



Main window > **Devices** > Right-click > Click **Add Monitor Wall**

Add the required decoder to your Bosch VMS before you add the monitor wall.

Name

Type in a display name for your monitor wall.

Monitor

Select a monitor that is connected to a decoder.

If you add a decoder that has 2 monitors connected, you must display the **Edit Decoder** dialog box of the decoder and update the device capabilities of this decoder. For each monitor add a further monitor wall.

Maximum number of cameras to connect

Type in the maximum number of cameras that are allowed to be displayed in the monitor wall. If you leave the field empty, the operator can display as many cameras as Image panes on the monitor wall layout are available.

Enable thumbnails

Click to check if you want to display a snapshot in Operator Client for each monitor. This snapshot is regularly updated.

Initial sequence

Select a camera sequence for initial display on the monitor wall when the operator starts this monitor wall.

See also

- *Adding a monitor wall, page 164*

27.16

Communication Devices page



Main window > **Devices** > Expand >

Allows you to add or configure a communication device.



You can configure the following communication devices:

- E-mail
- SMS (GSM or SMSC dial-up provider)

See also

- *Adding a device manually, page 155*
- *Configuring a communication device, page 164*

27.16.1 E-mail/SMTP Server dialog box

Main window >  **Devices** > Expand  > Right-click  > **Add E-mail/SMTP Device** command

Allows you to add an e-mail server to your Bosch VMS.

Name:

Type the display name of the e-mail server.

See also

- *Adding a device manually, page 155*

27.16.2 Add SMS Device dialog box

Main window >  **Devices** > Expand  > Right-click  > **Add SMS Device** command

Allows you to add an SMS device to your system.

Name:

Type the name of the SMS server that is used for being displayed.

GSM modem

Click to add a GSM modem.

SMSC dial up

Click to add a Hayes compatible modem which can connect to an SMSC provider.

See also

- *Adding a device manually, page 155*

27.16.3 SMTP Server page

Main window >  **Devices** > Expand  > Expand  > 

Allows you to configure the e-mail settings of your system. On the **Events** page, you can assign an event to an e-mail. When this event occurs, the systems sends an e-mail. You cannot receive e-mails in Bosch VMS.

SMTP server name

Type the name of the e-mail server. You get the information about the required entry from your provider. Usually this is the IP address or DNS name of your e-mail server.

Sender address

Type the email the email address which is used as the sender address when the system sends an email, for example in case of an alarm.

SSL/TLS

Select the check box to enable the usage of a secure SSL/TLS connection. In this case the network port switches automatically to 587.

Port

Type the required network port number for outgoing mails. You get the information about the required entry from your provider.

Port 25 is selected automatically when you disable the **SSL/TLS** setting.

You can select another port if required.

Connection time-out [s]

Type the number of seconds of inactivity until the connection is disconnected.

Authentication

Select a check box for the required authentication method. You get the information about the required entry from your provider.

User name

Type the user name for authenticating at the e-mail server. You get the information about the required entry from your provider.

Password:

Type the password for authenticating at the e-mail server. You get the information about the required entry from your provider.

Send Test E-mail

Click to display the **Send Test E-mail** dialog box.

See also

– *Configuring a communication device, page 164*

27.16.4

Send Test E-mail dialog box



Main window >

Devices >

Expand



> Expand



>



> **Send Test E-mail**

button

Allows you to send a test e-mail.

From:

Type the e-mail address of the sender.

To

Type the e-mail address of the recipient.

Subject

Type the subject of the e-mail.

Message

Type the message.

Send Test E-mail

Click to send the e-Mail.

See also

– *Configuring a communication device, page 164*

27.16.5 GSM Settings / SMSC Settings page



Main window > **Devices** > Expand



> Expand



Allows you to configure the SMS settings of your Bosch VMS. On the **Events** page, you can assign an event to a short message. When this event occurs, the system sends a short message. If the number of entered characters exceeds the highest permitted number (usually 160), an SMS is divided into multiple parts.

Device:

Select the required COM port where the external modem is connected to. If your computer has an internal modem, select the corresponding entry.

Speed

Select the required transfer rate.

PIN (for GSM device only)

Type the personal identification number for authenticating at the device.

Data format (for SMSC device only)

Select the required data format. You get the information about the required entry from your provider.

Unicode (for GSM device only)

Select the check box to enable unicode characters. This reduces the highest number of permitted characters to 80.

Dial string (for SMSC device only)

Type the number to connect to the SMSC dial-up provider. You get this number from your provider.

Password: (for SMSC device only)

Type the password that the device needs to connect to the SMSC dial-up provider if required. You get the information about the required entry from your provider.

Protocol (for SMSC device only)

Select the required protocol that the device uses to connect to the SMSC dial-up provider. You get the information about the required entry from your provider.

Recipient

Type the mobile phone number of the recipient of the short messages. Include the country prefix without + sign (e.g. +49170123456).

Message (max. 160 chars)

Type the text for the short message.

SMS Test Message

Click to send a test short message.

See also

- *Configuring a communication device, page 164*

27.17 ATM/POS page



Main window > **Devices** > Expand



>



Allows you to add and configure peripheral devices, for example, a Bosch ATM/POS Bridge.

If you want to add multiple bridges at one server, you must use different ports.

See also

- *Adding a device manually, page 155*
- *Adding a Bosch ATM/POS bridge, page 220*
- *Configuring a peripheral device, page 164*

27.17.1 Add Bosch ATM/POS-Bridge dialog box



Main window > **Devices** > Expand > Right-click > **Add Bosch ATM/POS-Bridge** command

Allows you to add a Bosch ATM/POS Bridge.

Name:

Type an appropriate name for the device.

IP address:

Type the IP address of the device.

Port 1:

Type the appropriate port number used as the listening port of the ATM/POS Bridge.

Port 2:

Type the appropriate port number used as the listening port of the Bosch VMS Management Server.

Caution!

When you add multiple ATM/POS Bridges to your system, ensure that the numbers for port 2 of each device deviate. Using the same number for port 2 multiple times can lead to ATM/POS data loss.

See also

- *Adding a device manually, page 155*
- *Adding a Bosch ATM/POS bridge, page 220*

27.17.2 Bosch ATM/POS-Bridge page



Main window > **Devices** > Expand > Expand > **Bosch ATM/POS-Bridge** tab

Allows you to configure a Bosch ATM/POS Bridge.

IP address:

Type in the IP address of the device.

Port 1:

Type the appropriate port number used as the listening port of the ATM/POS Bridge.

Port 2:

Type the appropriate port number used as the listening port of the Bosch VMS Management Server.

Caution!

When you add multiple ATM/POS Bridges to your system, ensure that the numbers for port 2 of each device deviate. Using the same number for port 2 multiple times can lead to ATM/POS data loss.

See also

- *Configuring a peripheral device, page 164*
- *Adding a Bosch ATM/POS bridge, page 220*

27.17.3**Inputs page**





Main window >  **Devices** > Expand  > Expand  >  > **Inputs** tab

Allows you to configure the inputs of a Bosch ATM/POS Bridge.

See also

- *Configuring a peripheral device, page 164*
- *Adding a Bosch ATM/POS bridge, page 220*

27.17.4**DTP Settings page**

Main window >  **Devices** > Expand  > Expand  > 

Allows you to configure a DTP device with maximum 4 ATM devices connected to this DTP device.





Serial port

In the list, select the appropriate port.

See also

- *ATM Settings page, page 258*
- *Configuring a peripheral device, page 164*

27.17.5**ATM Settings page**

Main window >  **Devices** > Expand  > Expand  >  > 

Allows you to configure an ATM device that is connected to a DTP.

Input number of the DTP device

Select the desired input number. If the number is already used by another ATM device, you can swap the input numbers.

Connection timeout [hours]

Enter the desired number of hours. When during this time period the ATM device did not send any transaction data, Bosch VMS assumes that the connection is disconnected. A corresponding event is triggered. The **Not Authenticated** event is available for an ATM device but not relevant.

Entering **0** means that no connection check is performed.

Data Inputs



Click to enable the desired inputs and type in a desired name for the inputs.

See also

– *Configuring a peripheral device, page 164*

27.18 Foyer Card Readers



Main window >  **Devices** > Expand >  >  > **Global Settings for Foyer Card Readers** tab

You can configure the settings that are valid for all foyer card readers in your system.

Serial port

Select the serial port to which the foyer card reader is connected.

Locked Out

Allows you to add bank routing codes for locking out. This means that cards with the lock characteristics entered here do not have access authorization. Access is denied by the foyer card reader. The default mode of electric door lock release of the foyer card reader must be set to: **Automatic**

The list may contain entries with wildcards:

?: Indicates any or no character at this position.

*: Indicates a sequence (one or more characters) of any or no characters (exception: * on its own means that all bank sort codes are locked out).

Ignore country code on EC cards

Click to enable that Bosch VMS does not analyze card data that is used to identify in which country the card was issued. Access is possible for cards with a different country code.

27.18.1 Add Foyer Card Reader dialog box



Main window >  **Devices** > Expand >  > Right-click >  > **Add Foyer Card Reader** command

You can add a foyer card reader.

Name

Type in a name for the device.

Device identifier

Select a unique number for the device. If no numbers are available, the maximum number of foyer card readers have already been added to the system.

27.18.2 Settings for Foyer Card Reader page



Main window >  **Devices** > Expand >  >  >  > **Settings for Foyer Card Reader** tab

You can configure a foyer card reader.

Device identifier

Displays the unique number of the device.

Enable skimming protection

Click to enable that Bosch VMS triggers an event when an attached skimming device detects skimming. This is not supported by all types of foyer card readers.

Default mode of electric door lock release

Open: The door is open and everybody can access without a card.

Closed: The door is closed, no matter what card is inserted.

Automatic: The door only opens when a card with access authorization is inserted in the reader.

Enable schedule-based control

Click to enable that you can assign a schedule to the selected release mode of the door lock. When a schedule becomes active, Bosch VMS switches the foyer card reader to the corresponding release mode.

If the selected schedules overlap, the effective door release mode is determined by the following priority of modes: 1. **Open** 2. **Closed** 3. **Automatic**

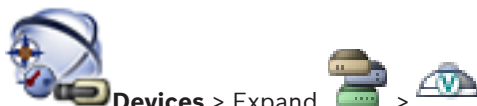
27.19 Virtual Inputs page

Main window > **Devices** > Expand > **Add Inputs** button
Displays the virtual inputs configured in your system.
Allows you to add new virtual inputs and to delete existing ones.

Add Inputs

Click to display a dialog box for adding new virtual inputs.

Delete Inputs

Click to delete a selected virtual input.

Number

Displays the number of the virtual input.

Name

Click a cell to modify the name of the virtual input.

See also

- *Adding a device manually, page 155*

27.19.1 Add Virtual Inputs dialog box

Main window > **Devices** > Expand > **Add Inputs** button
Allows you to add new virtual inputs.

Start:

Select the first number of the new virtual inputs.

End:

Select the last number of the new virtual inputs.

Name:

Type in the name of each new virtual input. A consecutive number is appended.

Add



Click to add new virtual inputs.

See also

- *Adding a device manually, page 155*

27.20 SNMP page





Main window > **Devices** > Expand  > 
Allows you to add or configure an SNMP measurement for maintaining the network quality.

See also

- *Adding a device manually, page 155*
- *Configuring an SNMP trap receiver, page 165*

27.20.1 Add SNMP dialog box



Main window > **Devices** > Expand  > Right-click  > **Add SNMP** command
Allows you to add a network monitoring system to your Bosch VMS.

Name:



Type a name for the network monitoring device.

See also

- *Configuring an SNMP trap receiver, page 165*

27.20.2 SNMP Trap Receiver page



Main window > **Devices** > Expand  > Expand 
Allows you to select devices for monitoring and to select SNMP trap OIDs that trigger an event for the selected device when they are received.



Notice!

You must enter the IP address of the Bosch Video Management System Management Server as the trap receiver in your devices that you want to monitor.

SNMP Trap Sending Devices:

Allows you to enter a range of IP addresses of the monitored network devices. To monitor a single device enter the corresponding IP address in the **Range From** cell.

Be careful when changing these addresses. Entering a wrong address stops network monitoring of this device.

SNMP Trap Filter Rules:

Allows you to enter OIDs and corresponding values. You can use wildcards as * and ? to enhance the filter range. If you enter OIDs and values in more than one row, these filter rules must match simultaneously to trigger an event. In both columns, you can enter a regular expression in {}. If there are characters outside the brackets, the regular expression is not evaluated.

Show Trap Logger Tool

Click to display the **SNMP Trap Logger** dialog box for tracing SNMP trap OIDs.

See also

- *Configuring an SNMP trap receiver, page 165*

27.20.3 SNMP Trap Logger dialog box



Main window > **Devices** > Expand  > Expand  > Select a generic SNMP Trap Receiver > Click **Show Trap Logger Tool**

Allows you to trace SNMPtrapOIDs. You can receive traps from all devices in your network or only from selected ones. You can filter the traps to be received and you can add OIDs and values of selected traps to the **SNMP Trap Filter Rules:** table.

Start/Pause

Click to start or stop a tracing process.

Only Traps From Sender

Enter the IP address or DNS name of a device. Only traps from this device are traced.

Only Traps Containing

Enter a string a trap can contain. You can use * and ? as wildcards. Strings in {} are treated as regular expressions. Only traps containing such a string are traced.

Received Traps

Displays the traps that are received by a tracing process.



Click to remove all entries in the **Received Traps** field.

Trap Details

Displays the trap details. You can copy the OID and the Value entry to the **SNMP Trap Filter Rules:** table.

See also

- *Configuring an SNMP trap receiver, page 165*

27.21 Assign Keyboard page



Main window > **Devices** > Expand  > 

Allows you to add a KBD-Universal XF keyboard (connected to a Bosch VMS workstation) or a Bosch IntuiKey keyboard (connected to a Bosch VMS workstation or to a decoder).

Add Keyboard

Click to add a row to the table for configuring a keyboard.

Delete Keyboard

Click to remove the selected row.

Keyboard Type

Displays the type of the keyboard that is connected to your workstation or decoder.

Click a cell to select the required keyboard type.

- **IntuiKey**
Select this type if you have attached an IntuiKey keyboard from Bosch.
- **KBD-Universal XF**
Select this type if you have attached a KBD-Universal XF keyboard.

Connection

In a cell, select the device your keyboard is connected to. If you select a workstation, the keyboard is also added to the  >  page.

Port

In a cell, select the desired COM port.

Baudrate

In a cell, select the maximum rate, in bits per second (bps), that you want data to be transmitted through this port. Usually, this is set to the maximum rate supported by the computer or device you are communicating with.

Data Bits

Displays the number of data bits you want to use for each character that is transmitted and received.

Stop Bits

Displays the time between each character being transmitted (where time is measured in bits).

Parity

Displays the type of error checking you want to use for the selected port.

Port Type

Displays the connection type that is used to connect the Bosch IntuiKey keyboard with the workstation.

See also

- Adding a device manually, page 155
- Configuring a decoder for use with a Bosch IntuiKey keyboard, page 160
- Configuring a Bosch IntuiKey keyboard (workstation), page 165
- Configuring a Bosch IntuiKey keyboard (decoder), page 165

27.22

I/O Modules page

Main window >  **Devices** > Expand  > 

Allows you to add or configure an I/O module.
Currently only ADAM devices are supported.

See also

- Adding a device manually, page 155
- Configuring an I/O module, page 166

27.22.1

ADAM page

Main window >  **Devices** > Expand  >  >  > **ADAM** tab

Displays information on the selected ADAM device.
Allows you to change the display name of an ADAM device.

ADAM type:

Select the appropriate device type.

Inputs total:

Displays the total number of inputs available with this device type.



Relays/Outputs total:

Displays the total number of relays available with this device type.

See also

- *Adding a device manually, page 155*

27.22.2**Inputs page**

Main window >  **Devices** > Expand  >  > **Inputs** tab

Allows you to change the display names of the inputs of the selected ADAM device.

Number

Displays the logical number of the input.

Name

Click a cell to change the display name of an input.

See also

- *Adding a device manually, page 155*

27.22.3**Relays page**

Main window >  **Devices** > Expand  >  > **Relays** tab

Allows you to change the display names of the relays of the selected ADAM device.

Number

Click a cell to change the logical number of a relay.



Name

Type the display name of the relay.

See also

- *Adding a device manually, page 155*

27.23**Allegiant CCL Emulation page**

Main window >  **Devices** > Expand  > 

Allows you to activate the Allegiant CCL emulation.

Allegiant CCL commands supported in Bosch VMS, page 80 lists the CCL commands supported in Bosch Video Management System.

Note:

Do not configure the Allegiant CCL emulation and an Allegiant device to the same COM port. If for both devices the same COM port is configured, the Allegiant device wins. The access of the Allegiant CCL emulation device fails with an appropriate message.

To solve this, the Management Server must have two different COM ports or connect the Allegiant device to another computer.

Enable Allegiant CCL Emulation

Select the check box to enable the emulation.

Baud rate

Select the value for the transmission rate in bit/s.

Stop bits

Select the number of stop bits per character.

Parity check

Select the type of parity check.

Handshake

Select the desired method for flow control.

Model

Select the Allegiant model that you want to emulate.

See also

- *Configuring an Allegiant CCL emulation, page 166*

27.24 Mobile Video Service page



Main window > **Devices** >

Allows you to add one or more transcoding service entries to your Bosch VMS. This transcoding service adapts the video stream from a camera configured in Bosch VMS to the available network bandwidth. This enables mobile video clients like an iPhone, iPad or Web Client to receive live or playback video data via unreliable network connections with limited bandwidth.

See also

- *Adding a Mobile Video Service, page 167*

27.24.1 Add Mobile Video Service dialog box



Main window > **Devices** > Right-click > Click **Add Mobile Video Service**

URI

Type in the URI of your Mobile Video Service. Follow the syntax rules of the example:

https://www.MyDomain.org/mvs

You must start the entry always with https://, even when you did not configure an encrypted access to your Web server.

See also

- *Adding a Mobile Video Service, page 167*

27.25 Intrusion panels page

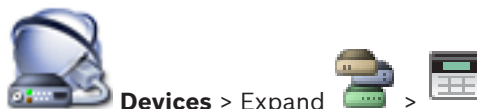

Main window > **Devices** > Expand >

Allows you to add and configure intrusion panels from Bosch. The device must be connected and available.

When you have added an intrusion panel, the areas, points, doors, and relays are displayed in the Device Tree hierarchically.

You can remove or rename the panel, each area, each point, each door, and each relay.

When the configuration on the intrusion panel was changed, you must rescan the device to display the changes in Bosch VMS.



Notice!

All alarm events that can occur at a point, are automatically configured as a Bosch VMS alarm. Example: Fire alarm



Warning!



If a door is not assigned to a point in the configuration of an intrusion panel that is added to your Bosch VMS, an alarm from this door does not trigger a Bosch VMS event and hence no Bosch VMS alarm.

See also

- *Adding a device manually, page 155*

27.25.1

Add Intrusion Panel dialog box

Main window >  **Devices** > Expand  > Right-click  > **Add Panel** command
Allows you to add an intrusion panel from Bosch.

Network address

Type in the IP address of the device.

Network port



Select the port number configured in the device.

Automation passcode

Type in the passcode for authenticating at the device.



27.25.2

Settings page

Main window >  **Devices** > Expand  > Expand  > **Settings** tab
Allows you to change the connection settings of the intrusion panel.

27.26

Video Analytics Settings page

Main window >  > **Devices** > Expand  > Expand  > **Video Analytics** > **Video Analytics Settings** page

You can add a server-based video analytics device.

The credentials and the installation path to the analytics viewer application used for the video analytics device must be available.

Network address

Type in the IP address of the video analytics device. DNS name is not allowed.

User name

Type in the user name as configured in the video analytics device. Use the same user name that Bintelan Bosch Client is using for connection with Bosch VMS.

Password

Type in the password as configured in the server-based analytics device. Use the same password that Bintelan Bosch Client is using for connection with Bosch VMS.

Analytics viewer path

Type in the relative path of the installation path of the analytics viewer application. The path is relative to C:\Program Files (x86)\ on the computer where the viewer application is used. Example: The analytics viewer application (AnalyticsViewer.exe) is installed in the following directory:

C:\Program Files (x86)\VideoAnalytics\

Configure the following path in the **Analytics viewer path** field:

VideoAnalytics\AnalyticsViewer.exe

See also

- *Configuring server-based video analytics, page 173*

27.26.1

Add Video Analytics Device dialog box



Main window >  > **Devices** > Right-click  > **Add Video Analytics Device** command > **Add Video Analytics Device** dialog box

When adding a server-based analytics device, you type in the credentials for the new device.

Network address

Type in the IP address of the video analytics device. DNS name is not allowed.

User name

Type in the user name as configured in the video analytics device. Use the same user name that Bintelan Bosch Client is using for connection with Bosch VMS.

Password

Type in the password as configured in the server-based analytics device. Use the same password that Bintelan Bosch Client is using for connection with Bosch VMS.



See also

- *Adding a video analytics device, page 174*

27.27



Bosch VMS Scan Wizard





Main window >  > **Devices** > Expand  > Right-click  > Click **Scan for Encoders** > **Bosch VMS Scan Wizard** dialog box



Main window >  > **Devices** > Expand  > Right-click  > Click **Scan for Video Streaming Gateways** > **Bosch VMS Scan Wizard** dialog box

 Main window >  **Devices** > Right-click  > Click **Scan for Live Only Encoders**> **Bosch VMS Scan Wizard** dialog box

 Main window >  **Devices** > Right-click  > Click **Scan for Local Storage Encoders** > **Bosch VMS Scan Wizard** dialog box

 Main window >  **Devices** > Expand  > Expand  > Right-click  > Click **Scan for Decoders** > **Bosch VMS Scan Wizard** dialog box

This dialog box allows you to scan for available devices in your network, configure them and add them to your system in one process.

Use

Click to select a device for adding to the system.

Type (not available for VSG devices)

Displays the type of the device.

Display Name

Displays the device name that was entered in the Device Tree.

Network Address

Displays the IP address of the device.

User Name

Displays the user name that is configured on the device.

Password

Type in the password for authenticating with this device.

Status

Displays the status of authentication.



: Succeeded



: Failed

 Main window >  **Devices** > Right-click  > Click **Scan for VRM Devices**> Bosch VMS Scan Wizard dialog box



Notice!

For configuring a Secondary VRM you must first install the appropriate software on the desired computer. Run Setup.exe and select **Secondary VRM**.

Role

In the list, select the desired entry.

The following table lists which roles each VRM type can have:

Role / Type	Primary VRM	Secondary VRM
-------------	-------------	---------------

Primary (Normal)	X	
Secondary (Normal)		X
Primary Failover	X	
Secondary Failover		X
Mirrored		X

To a Primary VRM you can add a VRM device with the following roles:

- Failover VRM
- Mirrored VRM

To a Secondary VRM you can add VRM devices with the following role:

- Failover VRM

Master VRM

In the list, select the desired entry.

User Name

Displays the user name that is configured on the VRM device.

You can type in another user name if required.

See also

- *Scanning for VRM devices, page 125*
- *Adding an encoder to a VRM pool, page 169*
- *Adding a live only encoder, page 169*
- *Adding a local storage encoder, page 170*
- *Scanning for devices, page 83*

27.28

VRM Devices page



Main window > **Devices** > Expand

Allows you to add and configure VRM devices. A VRM device needs at least an encoder, an iSCSI device, and a LUN assigned to the iSCSI device, and a storage pool. See the Release Notes and the data sheet for current firmware versions.

Caution!

After you have added an iSCSI device with respective encoders to your Bosch VMS, you must add the IQN of each encoder to this iSCSI device (valid for some iSCSI device types).

See *Configuring an iSCSI device, page 130* for details.

Caution!

Ensure that the time of the VRM computer is synchronized with the Management Server. Otherwise you can loose recordings.

Configure the time server software on the Management Server. On the VRM computer, configure the IP address of the Management Server as time server using standard Windows procedures.



As of Bosch VMS 6.0, VRM 3.50 is supported. When you do not upgrade VRM to version 3.50 during the upgrade to Bosch VMS 6.0, recording continues but you cannot change the configuration of the old VRM.

If you upgraded your VRM software to version 3.50, you must manually synchronize the Bosch VMS configuration.

See also

- *Synchronizing Bosch VMS configuration, page 125*
- *VRM Settings page, page 271*
- *Pool page, page 272*
- *iSCSI device page, page 277*
- *Changing the password of a VRM device, page 133*

27.28.1**Add VRM dialog box**

Main window >  **Devices** > Right-click  > Click **Add VRM** > **Add VRM** dialog box
Allows you to add a VRM device. You can select the type of the device and enter the credentials.

You can effectively assign a Failover VRM to a Master VRM only when both are online and are successfully authenticated. The passwords are then synchronized.

Name

Type in a display name for the device.

Network address / port

Type in the IP address of your device.

Type

Select the desired device type.

User name

Type in the user name for authentication.

Password

Type in the password for authentication.

Show password

Click to enable that the password is visible.

Test

Click to check whether the device is connected and authentication is successful.

Properties

If required, change the port numbers for the HTTP port and for the HTTPS port. This is only possible when you add or edit a VRM that is not connected. If the VRM is connected, the values are retrieved and you cannot change them.

The **Master VRM** table row shows the selected device if applicable.

See also

- *Adding a Primary VRM manually, page 126*
- *Adding a Secondary VRM manually, page 126*
- *Adding a Mirrored VRM manually, page 127*
- *Adding a Failover VRM manually, page 127*

27.28.2 Add Failover VRM dialog box



Main window >  **Devices** > Expand  > Right-click  > Click **Add Failover VRM** > **Add Failover VRM** dialog box

You can effectively assign a Failover VRM to a Master VRM only when both are online and are successfully authenticated. The passwords are then synchronized.

You can add a Failover VRM device. You can either add it manually or you can select a device from a list of scanned VRM devices.

Network address

Type in the IP address of your device or select a network address in the **Scanned VRMs** list.

Scanned VRMs

Displays the list of scanned VRM computers. To rescan, close the dialog box and display the dialog box again.

27.29 VRM Settings page



Main window >  **Devices** > Expand  >  > **Main Settings** > **VRM Settings**

Server initiator name

Displays the iSCSI initiator name of VRM Server.

System-wide CHAP password

Enter the password that you have configured in the iSCSI storage device. The CHAP password is valid for the VRM and is sent to all devices automatically. Replay clients do not need additional configuration. You must configure the iSCSI systems manually with the CHAP password. If you are using a CHAP password, all storage systems have to be configured to use the CHAP password. Only one system wide CHAP password is supported by the VRM system.

27.29.1 SNMP page



Main window >  **Devices** > Expand  > Expand  > **Network** > **SNMP**

1. SNMP host address 2. SNMP host address

VRM supports the SNMP (Simple Network Management Protocol) for managing and monitoring network components, and can send SNMP messages (traps) to IP addresses. The unit supports SNMP MIB II in the unified code. If you wish to send SNMP traps, enter the IP addresses of one or two required target units here.

Some events are sent as SNMP traps only. Refer to the MIB file for descriptions.

27.29.2 Accounts page

In order to configure image posting, and to export video in MP4 file format, you must create an Account in which to save and access them. You can create a maximum of four (4) accounts.

Type

Select the type of account: **FTP** or **Dropbox**.

IP address

Enter the IP address of the server on which you wish to save the images.

User name

Enter the user name for the server.

Password

Enter the password that gives you access to the server. To verify the password, click **Check** to the right.

Check

Click to verify the password.

Path

Enter the exact path on which you wish to post the images and video on the server.

27.29.3**Advanced page**

Main window >  **Devices** > Expand  > Expand  > **Service** > **Advanced**

RCP+ logging / Debug logging / Replay logging / VDP logging / Performance logging

Activate the different logs for VRM Server and Configuration Manager.

The log files for VRM Server are stored on the computer on which VRM Server has been started, and can be viewed or downloaded with VRM Monitor.

The log files for Configuration Manager are stored locally in the following directory:
%USERPROFILE%\My Documents\Bosch\Video Recording Manager\Log

Retention time (days)

Specify the retention time for log files in days.

Complete memory dump file

Only activate this option if necessary, for example if the Technical Customer Service team requests a complete summary of the main memory.





Telnet support

Activate this option if access with the Telnet protocol is to be supported. Only activate if necessary.

Caution!

Extensive logging requires considerable CPU power and HDD capacity.
Do not use extensive logging in continuous operation.

27.30**Pool page**

Main window >  **Devices** > Expand  > Expand  > 

Allows you to configure recording settings valid for all devices that are collected in this storage pool.

Pool identification

Displays the pool number.

Recording preferences mode– **Failover**

Recordings are saved only to primary target. If it is not possible to save to this target, the recording will be saved to the target entered under secondary target.

A failure situation is reached if the primary target does not provide storage blocks due to whatever reason: system down, network error, no capacity left.

You can leave the second list empty. In this case no failover is possible but the number of required iSCSI sessions is reduced and no disk space on secondary target is allocated. This reduces system overhead and extends the system retention time.

– **Automatic**

Load balancing is configured automatically. Each encoder is automatically assigned 2 iSCSI targets and blocks on these 2 iSCSI targets are assigned to the encoder.

Sanity check period (days)

Move the slider to configure the required time period. After this time period the iSCSI target is checked and blocks are reassigned if needed.

Secondary target usage

Enable or disable the use of a secondary target.

Block reservation for downtime

Enter the number of days that the assigned encoders will be recorded although the VRM Server is down.

For example, if you set 4, the encoders will be recorded during approximately 4 days of VRM Server downtime.

If your system has encoders with low bit rate, you can significantly reduce the pre-allocated disk space. This ensures a proper distribution of storage capacity and extends the retention time.

Allow LUNs larger than 2 TB

Click to enable the use of LUNs that are larger than 2 TB.

LUNs larger than 2 TB ("large LUNs") are not supported by the following devices:

- VRM devices earlier than 3.60
- VSG devices with firmware version earlier than 6.30
- Encoders with firmware version earlier than 6.30

Bosch VMS prevents you to perform the following procedures:

- Add or move devices with firmware version earlier than 6.30 to a pool that allows large LUNs.
- Add or move devices that are currently not connected to the network, to a pool that allows large LUNs.
- Add or move an iSCSI device that contains large LUNs, to a pool that does not allow large LUNs.
- Allow large LUNs on a pool that contains devices with firmware version earlier than 6.30.
- Disable large LUNs on a pool with an iSCSI device that contains large LUNs.

Please move devices with firmware earlier than 6.30 to a pool that does not allow large LUNs.

See also

- *Adding a LUN, page 132*
- *Adding a VRM pool, page 128*





27.30.1

Add Encoder / Add Decoder dialog box

 Main window >  **Devices** > Expand  > Expand  > Right-click  > Click **Add Encoder** > **Add Encoder** dialog box
 or

 Main window >  **Devices** > Right-click  > Click **Add Encoder** > **Add Encoder** dialog box
 or

 Main window >  **Devices** > Right-click  > Click **Add Encoder** > **Add Encoder** dialog box
 or

 Main window >  **Devices** > Expand  > Expand  > Right-click  > Click **Add Encoder** > **Add Encoder** dialog box
 or

 Main window >  **Devices** > Expand  > Right-click  > Click **Add Decoder** > **Add Decoder** dialog box

Allows you to add an encoder or decoder manually. This is especially useful when you want to add any Video IP device from Bosch (only for VRM).

IP address:

Type in a valid IP address.

Encoder type: / Decoder type:

For a device with known device type, select the appropriate entry. It is not necessary that the device is available in the network.





If you want to add any Video IP device from Bosch, select **<Auto Detect>**. The device must be available in the network.

See also

- *Adding a device manually, page 155*

27.30.2

Edit Encoder / Edit Decoder dialog box



 Main window >  **Devices** > Expand  > Expand  > Right-click  > Click **Edit Encoder** > **Edit Encoder** dialog box
 or

 Main window >  **Devices** > Right-click  > Click **Edit Encoder** > **Edit Encoder** dialog box
 or

 Main window >  **Devices** > Right-click  > Click **Edit Encoder** > **Edit Encoder** dialog box
 or

Main window >  **Devices** > Expand  > Expand  > Right-click  > Click **Edit Encoder** > **Edit Encoder** dialog box
or

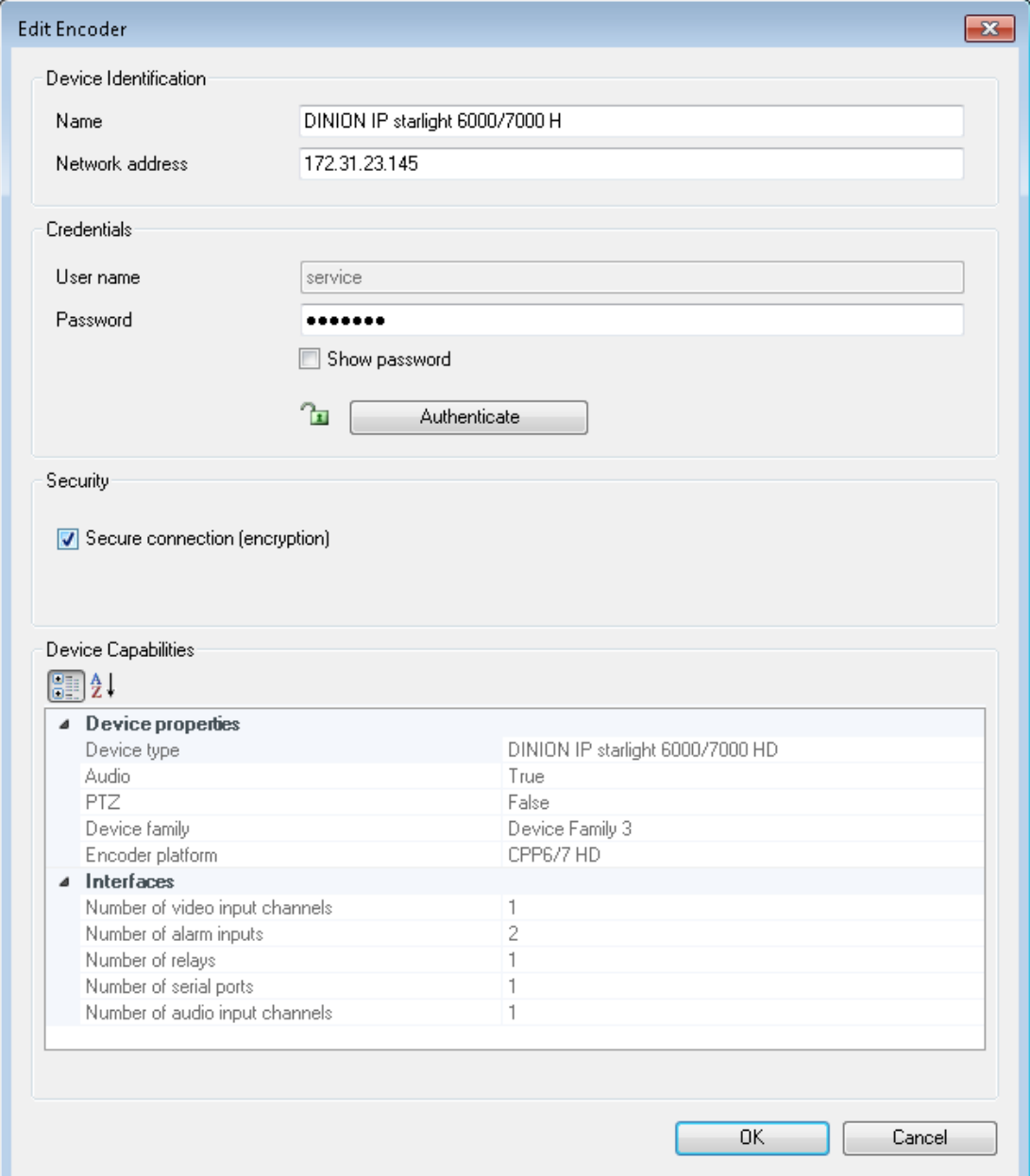
Main window >  **Devices** > Expand  > Right-click  > Click **Edit Decoder** > **Edit Decoder** dialog box



Device Identification

Name: DINION IP starlight 6000/7000 H
Network address: 172.31.23.145

Credentials

User name: service
Password: ●●●●●●
 Show password
Authenticate

Security

Secure connection (encryption)

Device Capabilities

Device properties	
Device type	DINION IP starlight 6000/7000 HD
Audio	True
PTZ	False
Device family	Device Family 3
Encoder platform	CPP6/7 HD
Interfaces	
Number of video input channels	1
Number of alarm inputs	2
Number of relays	1
Number of serial ports	1
Number of audio input channels	1

OK Cancel

Allows you to check and update the device capabilities of a device. On opening this dialog box the device is connected. The password is checked and the device capabilities of this device are compared with the device capabilities stored in Bosch VMS.

Name

Displays the device name. When you add a Video IP device from Bosch, the device name is generated. If required change the entry.

Network address

Type in the network address of the device.

User name

Displays the user name used for authenticating at the device.

Password

Type in the valid password for authenticating at the device.

Show password

Click to enable that the entered password is displayed. Be careful that nobody can spy out this password.

Authenticate

Click to authenticate at the device with the credentials entered above.

Secure connection (encryption)

You can activate the encryption of live video transferred from an encoder to the following devices if HTTPS port 443 is configured on the encoder:

- Operator Client computer
- Management Server computer
- Configuration Client computer
- VRM computer
- Decoder

Note:

When activated, the user of Operator Client cannot switch a stream to UDP and to UDP multicast.

When activated, ANR does not work for the affected device.

When activated, encoder replay does not work on encoders with firmware earlier than 6.30.

Device Capabilities





You can sort the displayed device capabilities per category or alphabetically.

A message text informs you whether the detected device capabilities match the current device capabilities. Click **OK** to apply the changes of the device capabilities after an upgrade of the device.



See also

- *Encrypting live video, page 145*
- *Updating the device capabilities, page 138*

27.30.3**Change Pool for dialog box**

Main window > **Devices** > Expand  > Expand  >  > Right-click  > **Change Pool ...** command > **Change pool** dialog box
or

Main window > **Devices** > Expand  > Expand  >  > Right-click  > **Change Pool ...** command > **Change pool** dialog box
or

Main window > **Devices** > Expand  > Expand  > Right-click  > **Change Pool ...** command > **Change pool** dialog box
Allows you to change the pool assignment of a device.

Current Pool:

Displays the number of the pool which the selected device is currently assigned to.

New Pool:

Select the desired pool number.

See also

- *Moving an encoder to another pool, page 136*
- *Moving an iSCSI system to another pool, page 131*
- *Moving a VSG to another pool, page 149*

27.30.4**Add Video Streaming Gateway dialog box**

Right-click  > **Add Video Streaming Gateway** > **Add Video Streaming Gateway** dialog box

You can add VSG devices to a VRM pool.

Name

Type in the desired display name for the device.

Network address

Type in the network address of the device.

User name

Type in the user name used for authenticating at the device. Usually: service

Password

Type in the valid password for authenticating at the device.

Show password

Click to enable that the entered password is displayed. Be careful that nobody can spy out this password.

Test

Click to authenticate at the device with the credentials entered above.

See also

- *Video Streaming Gateway device page , page 282*

27.31**iSCSI device page**

You can either add a E-Series iSCSI device or any other supported iSCSI device.

See also

- *Adding an iSCSI device, page 128*
- *Adding a DSA E-Series iSCSI device, page 129*
- *Configuring an iSCSI device, page 130*
- *Adding a LUN, page 132*
- *Formatting a LUN, page 133*

27.31.1 Add iSCSI Device dialog box

Main window >  **Devices** >  > Expand  > Right-click  > **Add iSCSI**

Device > **Add iSCSI Device** dialog box

Allows you to add an iSCSI devices to a VRM.

Name

Type in a display name for the device.

Network Address

Type in a valid network address of the device.

iSCSI device type

Select the appropriate device type.

Password

Type in the password for authenticating at the device.





Related Topics

- *Scanning for VRM devices, page 125*

See also

- *Adding a DSA E-Series iSCSI device, page 129*

27.31.2 Add DSA E-Series Device dialog box

Main window >  **Devices** >  > Expand  > Right-click  > **Add DSA E-Series Device** > **Add DSA E-Series Device** dialog box

Allows you to add a DSA E-Series iSCSI device. This device type has a management IP address different from the IP address of the iSCSI storage. Via this management IP address the device is automatically detected and configured.

Name

Type in a display name for the device.

Management address

Type in the IP address for automatic configuration of the device.

Password

Type the password of this device.

DSA E-Series type

Displays the device type.

Network address iSCSI Ch 3

Displays the IP address of the iSCSI port of the device. If available you can select another IP address.

Management address

Displays the IP address for automatic configuration of the second controller if available. If available you can select another IP address.

Network address iSCSI Ch 3

Displays the IP address of the iSCSI port of the second controller if available. If available you can select another IP address.

Connect

Click to detect the settings of the device.





If connection is established, the fields in the **Controller** group and the **2nd Controller** group are filled.

See also

- Adding a DSA E-Series iSCSI device, page 129

27.31.3

Load Balancing dialog box

Main window >  **Devices** > Expand  > Expand  > Expand  > Right-click  > **Load Balancing...** command > **Load Balancing** dialog box

Prerequisite: Configure the **Automatic** recording mode.

Set the upper limits for the permitted bit rate and the number of simultaneous iSCSI connections for each iSCSI system. If these limits are exceeded, data is no longer being written to the iSCSI system and is lost.

For supported systems (for example Bosch RAID, NetApp, DLA), use the default values. For another device see the documentation of this device. Start testing with small values.

27.31.4

Basic Configuration page

Main window >  **Devices** > Expand  > Expand  > Expand  > Click  > **Basic Configuration** tab

Allows you to perform a basic configuration of your iSCSI device. You create LUNs on the iSCSI hard drive and format these LUNs.

Only displayed if the device is one of the iSCSI storage systems supported by Bosch, for example DSA or DLS 1x00.

The displayed options can differ depending on the used type of iSCSI storage system.



Notice!

After the basic configuration of an E-Series the system needs many hours (or even days) to initialize. In this phase the full performance is not available and in phase 1.5 formatting can fail.

Physical capacity [GB]

Information on the total capacity of the storage system.

Number of LUNs

You can change the number of LUNs.



Notice!

If you change the number of LUNs, the entire iSCSI system is reorganized and any sequences saved on the system are lost.

Therefore, before making changes, check the recordings and back up any important sequences.

Capacity for new LUNs [GB]

This option is only displayed for E-Series.

As 256 is the maximum number of LUNs of a storage array, the LUN size should not be set to a too small value (otherwise no more LUNs can be created in the future, if an additional shelf is installed).

Target spare disks

Number of spare disks the user wants the system to have.

Actual spare disks

Number of spare disks which are currently in the system. This number can differ from the number above, e.g. if the storage system is reconfigured manually or if disks are broken.

Initialization status (%)

Additional information is displayed during initialization. When initialization is complete (100%), you will also have the opportunity to delete all LUNs again.

Note: On FAS storage systems, it can take several hours before LUNs are fully deleted. During that time, the total capacity of newly created LUNs can be reduced. You can only create new LUNs with full capacity after the old LUNs have been completely deleted.

RAID-DP (reliability focused)

Activate this option if you do not wish to use the specified RAID type RAID-4, but would prefer to use the more reliable RAID type RAID DP.

RAID 6 (reliability focused)

Activate this option if you do not wish to use the specified RAID type RAID-5, but would prefer to use the more reliable RAID type RAID 6.

Serial number

The serial number needed for support cases. It is only correct if the controller is not moved to a different shelf.

Delete all LUNs

As already stated above the user should wait some hours before he creates new LUNs.

Additional information

Additional information is displayed here, for example information that the storage system is not configured correctly and that therefore no setup is possible.

See also

- *Adding a DSA E-Series iSCSI device, page 129*

27.31.5

iqn-Mapper dialog box

Main window >  **Devices** > Expand  > Expand  > Expand  > Right-click  > **Map IQNs**

Allows you to start the IQN mapping process.

See also

- *Scanning for VRM devices, page 125*
- *Configuring an iSCSI device, page 130*

27.31.6

LUNs page



Allows you to add, remove, or format LUNs, and to view information on the LUNs.

Add

Click to display the **Add LUN** dialog box.

Remove

Click to remove the selected rows. To select a row, click the row header on the left side. Each row represents a LUN.

A message box is displayed.

Format LUN

Click to format the selected LUN. A message box is displayed.

Format

Click the check box to select the LUN and then click **Format LUN**.

LUN

Displays the name of the LUN.

Size [GB]

Displays the maximal capacity of the LUN.

Large LUN

Each cell displays whether this is a LUN larger than 2 TB or not.

State

Displays the state of the LUN.

Progress

Displays the progress of the formatting process.

See also

- *Pool page, page 272*
- *Adding a LUN, page 132*
- *Scanning for VRM devices, page 125*

27.31.7

Add LUN dialog box



Allows you to add a LUN.

Id

Enter the ID of the desired LUN.

See also

- *Adding a LUN, page 132*
- *Scanning for VRM devices, page 125*

27.32 Video Streaming Gateway device page

Main window >  **Devices** > Expand  > Expand  > Expand  > 

Allows you to add and configure the following encoder types:

- Bosch encoders
- ONVIF encoders
- JPEG encoders
- RTSP encoders

See also

- *ONVIF page, page 324*
- *Adding a Video Streaming Gateway device, page 148*

27.32.1 Multicast tab (Video Streaming Gateway)

Main window >  **Devices** > Expand  > Expand  > Expand  >  > **Network** tab > **Multicast** tab

Allows you to configure multicast for the assigned cameras.

Enable

Click to enable multicast for this camera.

Multicast Address

Insert a valid multicast address (in the range 224.0.0.0 - 239.255.255.255).

Type in 1.0.0.0. A unique multicast address is automatically inserted based on the MAC address of the device.

Port

When a firewall is used, enter a port value that is configured as non-blocked port in the firewall.

Streaming

Click to enable continuous multicast streaming to the switch. This means that the multicast connection is not preceded by a RCP+ registration. The encoder streams always all data to the switch. The switch in return (if no IGMP multicast filtering is supported or configured) sends this data to all ports, with the result that the switch will flood.

You need streaming when using a non-Bosch device for receiving a multicast stream.

See also

- *Configuring multicast, page 150*

27.32.2 Advanced tab (Video Streaming Gateway)

Main window >  **Devices** > Expand  > Expand  > Expand  >  > **Service** tab > **Advanced** tab

Allows you to activate logging for Video Streaming Gateway.

The log files are usually stored in the following path:

C:\Program Files (x86)\Bosch\Video Streaming Gateway\log

RCP+ logging

Click to enable RCP+ logging.

Debug logging

Click to enable debug logging.

RTP logging

Click to enable RTP logging.

Retention time (days)

Select the desired number of days.

Complete memory dump file

Only activate this option if necessary, for example if the Technical Customer Service team requests a complete summary of the main memory.

Telnet support

Activate this option if access with the Telnet protocol is to be supported. Only activate if necessary.

Caution!

Extensive logging requires considerable CPU power and HDD capacity.
Do not use extensive logging in continuous operation.

See also

– *Configuring logging, page 150*

27.32.3**Add Bosch Encoder dialog box**

Main window >  **Devices** > Expand  > Expand  > Expand  > Right-click

 > **Add Encoder/camera** > **Bosch Encoder** command

You can add an encoder from Bosch to your VSG device.

Name

Type in the desired display name for the device.

Network address

Type in the network address of the device.

Type

Displays the detected device type, if supported.

User name

Type in the user name used for authenticating at the device. Usually: service

Password

Type in the valid password for authenticating at the device.

Show password

Click to enable that the entered password is displayed. Be careful that nobody can spy out this password.

Test

Click to authenticate at the device with the credentials entered above.

Properties

Click to enable the desired features available for this device.

Audio	Click to activate audio if available for this device.
PTZ	Click to activate PTZ if available for this device.
Camera protocol	<p>TCP Used for transmission in the Internet and / or for lossless data transmission. Ensures that no data packet gets lost. Bandwidth requirement can be high. Use if the device is located behind a Firewall. Does not support multicast.</p> <p>UDP Used for connectionless and lightweight data transmission in private networks. Data packets can get lost. Bandwidth requirement can be low. Supports multicast.</p>
Use video input 1 - Use video input 4	Click to select the video inputs if you configure a multichannel device.

See also

- Adding a camera to a VSG, page 149



27.32.4

Add ONVIF Encoder dialog box

Main window >  **Devices** > Expand  > Expand  > Expand  > Right-click

 > **Add Encoder/camera** > **Add ONVIF Encoder** command

or

Main window >  **Devices** > Right-click  > **Add ONVIF Encoder** command

You can add an ONVIF encoder to your VSG device or as a live only encoder. You must configure the used profile for recording and live in the Camera Table.

Name

Type in the desired display name for the device.

Network address

Type in the network address of the device.

User name

Type in the user name used for authenticating at the device. Usually: service

Password

Type in the valid password for authenticating at the device.

Show password

Click to enable that the entered password is displayed. Be careful that nobody can spy out this password.

Test

Click to authenticate at the device with the credentials entered above.

Properties

Device type	Displays the retrieved device type.
Manufacturer	Displays the retrieved manufacturer name.
Model	Displays the retrieved model name.
Number of video input channels	Enter the number of desired video inputs.
Number of audio input channels	Enter the number of desired audio inputs.
Number of alarm inputs	Enter the number of desired alarm inputs.
Number of relays	Enter the number of desired relays.

See also

- Adding a camera to a VSG, page 149

27.32.5

Add JPEG Camera dialog box

Main window >  **Devices** > Expand  > Expand  > Expand  > Right-click

 > **Add Encoder/camera** > **JPEG camera** command

You can add a JPEG camera to your VSG device.

Name

Type in the desired display name for the device.

URL

Enter the URL of your JPEG camera / RTSP camera.

For a JPEG camera from Bosch, type in the following string:

`http://<ip-address>/snap.jpg?jpegCam=<channel_no.>`

For an RTSP camera from Bosch, type in the following string:

`rtsp://<ip-address>/rtsp_tunnel`

User name

Type in the user name used for authenticating at the device. Usually: service

Password

Type in the valid password for authenticating at the device.

Show password

Click to enable that the entered password is displayed. Be careful that nobody can spy out this password.

Test

Click to authenticate at the device with the credentials entered above.

Properties

Number of video input channels	Enter the number of available video inputs if available.
Frame rate [ips]	Enter the desired frame rate.

See also

- *Adding a camera to a VSG, page 149*

27.32.6

Add RTSP Encoder dialog box

Main window >  **Devices** > Expand  > Expand  > Expand  > Right-click  > **Add Encoder/camera > RTSP camera** command

You can add an RTSP encoder to your VSG device.

Name

Type in the desired display name for the device.

URL

Enter the URL of your JPEG camera / RTSP camera.

For a JPEG camera from Bosch, type in the following string:

```
http://<ip-address>/snap.jpg?jpegCam=<channel_no.>
```

For an RTSP camera from Bosch, type in the following string:

```
rtsp://<ip-address>/rtsp_tunnel
```

User name

Type in the user name used for authenticating at the device. Usually: service

Password

Type in the valid password for authenticating at the device.

Show password

Click to enable that the entered password is displayed. Be careful that nobody can spy out this password.

Test

Click to authenticate at the device with the credentials entered above.

Properties

Number of video input channels	Enter the number of available video inputs if available.
---------------------------------------	--

See also

- *Adding a camera to a VSG, page 149*

27.33

Live Only page



Main window >  **Devices** > Expand  > 

Allows you to add and configure encoders used for live only. You can add Bosch encoders and ONVIF network video transmitters.

See also

- *Adding a live only encoder, page 169*
- *Scanning for devices, page 83*
- *Bosch Encoder / Decoder page, page 290*
- *ONVIF page, page 324*



27.34 Local Storage page

Main window >  **Devices** > Expand  > 
Allows you to add and configure encoders with local storage.

See also

- *Adding a local storage encoder, page 170*
- *Bosch Encoder / Decoder page, page 290*
- *Scanning for devices, page 83*



27.35 Unmanaged Sites page

Main window >  **Devices** > Expand 
Allows you to add or remove **Unmanaged Sites** items. Unmanaged site items contain unmanaged network devices.

See also

- *Unmanaged site, page 31*
- *Adding an unmanaged site, page 123*
- *Importing unmanaged sites, page 123*
- *Configuring the time zone, page 124*

27.35.1 Add Unmanaged Site dialog box

Main window >  **Devices** > Expand  > Right-click  **Add Unmanaged Network Device** command > **Add Unmanaged Network Device** dialog box
You can add a video network device to the **Unmanaged Sites** item of the Device Tree. It is assumed that all unmanaged network devices of an unmanaged site are located in the same time zone.

Site name

Displays the name of the site that was entered during creation of this item.



Description

Type in a description for this site.

Time zone

Select the appropriate time zone for this unmanaged site.

27.35.2 Unmanaged Site page

Main window >  **Devices** > Expand  > 
You can add a video network device to the **Unmanaged Sites** item of the Device Tree. It is assumed that all unmanaged network devices of an unmanaged site are located in the same time zone.

Site name

Displays the name of the site that was entered during creation of this item.

Description

Type in a description for this site.

Time zone

Select the appropriate time zone for this unmanaged site.

27.35.3**Add Unmanaged Network Device dialog box**

Main window >  **Devices** > Right-click  > **Add Unmanaged Site** command > **Add Unmanaged Site** dialog box

You can add a video network device to the **Unmanaged Sites** item of the Device Tree. It is assumed that all unmanaged network devices of an unmanaged site are located in the same time zone.

Device type:

Select the entry that is applicable for this device.

Available entries:

- **DIVAR AN / DVR**
- **DIVAR IP 3000/7000 / Bosch VMS**

Network address:

Type in an IP address.

User name:

Type in the valid user name for this network device if available. See *Unmanaged site, page 31* for details.

Password:

Type in the valid password if available. See *Unmanaged site, page 31* for details on user credentials.

See also

- *Adding an unmanaged site, page 123*
- *Unmanaged site, page 31*

27.35.4**Unmanaged Network Device page**

Main window >  **Devices** > Expand  > Expand  > 

You can add a video network device to the **Unmanaged Sites** item of the Device Tree. It is assumed that all unmanaged network devices of an unmanaged site are located in the same time zone.

Device type:

Select the entry that is applicable for this device.

Available entries:

- **DIVAR AN / DVR**
- **DIVAR IP 3000/7000 / Bosch VMS**

Network address:

Type in an IP address.

User name:

Type in the valid user name for this network device if available. See *Unmanaged site, page 31* for details.

Password:

Type in the valid password if available. See *Unmanaged site, page 31* for details on user credentials.

28 Bosch Encoder / Decoder page

The count of items below an entry is displayed in square brackets.

To configure an encoder / decoder:

Main window >  **Devices** > Expand  > Expand  > Expand  > 

or



Main window >  **Devices** > Expand  > Expand  > Expand  > 

or

Main window >  **Devices** > Expand  > 

or

Main window >  **Devices** > Expand  > 

Main window >  **Devices** > Expand  > Expand  > 

Most of the settings on the encoder / decoder pages are active immediately after you click



. If you click another tab without clicking and changes have occurred, two corresponding message boxes are displayed. Confirm them both if you want to save.

To change the passwords of an encoder right-click the device icon and click **Change password...**

To display the device in a Web browser right-click the device icon and click **Show Webpage in Browser**.

Note:

Depending on the selected encoder or camera, not all pages described here are available for each device. The wording used here for describing the field labels can deviate from your software.

- ▶ Click a tab to display the corresponding property page.



See also



- *Scanning for devices, page 83*
- *Configuring an encoder / decoder, page 138*

28.1 Enter password dialog box

Main window >  **Devices** > Expand  > Expand  >  > Right-click  > **Change password...** command

 Main window >  **Devices** > Expand  > Right-click  > **Change password...** > **Enter password** dialog box

 Main window >  **Devices** > Expand  > Expand  > Expand  > Right-click  > **Change password...** command

 Main window >  **Devices** >  > Right-click  > **Change password...** command

 Main window >  **Devices** >  > Right-click  > **Change password...** command

A password prevents unauthorized access to the device. You can use different authorization levels to limit access.

Proper password protection is only guaranteed when all higher authorization levels are also protected with a password. Therefore, you always have to start from the highest authorization level when assigning passwords.

You can define and change a password for each authorization level if you are logged in as service or if the unit is not password protected.

Enter the password for the appropriate authorization level here. The maximum password text length is 19 characters and no special characters are allowed.

The device has three authorization levels: service, user, and live.

- service is the highest authorization level. Entering the correct password gives access to all the functions and allows all configuration settings to be changed.
- user is the middle authorization level. At this level you can operate the device, play back recordings, and also control camera, for example, but you cannot change the configuration.
- live is the lowest authorization level. At this level you can only view the live video image and switch between the different live image displays.

For a decoder the following authorization level replaces the live authorization level:

- destination password (only available for decoders)
Used for access to an encoder.

See also

- *Changing the password of an encoder / decoder, page 140*
- *Providing the destination password for a decoder, page 141*

28.2 Unit Access page

28.2.1 Identification / Camera identification

Device name

Type the name of the device.

The name simplifies the management of multiple devices in large systems. The name is used for identification of a device. Use a name that makes it as easy as possible to identify its location.

Do not use any special characters in the name. Special characters are not supported and may cause problems, e.g. with playback.



Click  to update the name in the Device Tree.

Each device should be assigned a unique identifier that can be entered here as an additional means of identification.

Initiator name

Displays the iSCSI initiator name. The initiator name is automatically displayed after a connection is established.

Initiator extension

Type your own text to make the unit easier to identify in large iSCSI systems. This text is added to the initiator name, separated from it by a full stop.

28.2.2

Camera name

Camera

Type the name of the camera. Ensure that Camera 1 is allocated to Video Input 1, Camera 2 to Video Input 2, etc.

The camera name facilitates the identification of the remote camera location, for example in case of an alarm. Use a name that makes it as easy as possible to identify the location.

Do not use any special characters in the name. Special characters are not supported and may cause problems, for example the play back of recordings. The settings on this page apply to all camera inputs.



Click  to update the name in the Device Tree.

28.2.3

Version information

Hardware version

Displays the version of the hardware.

Firmware version

Displays the version of the firmware.

28.3

Date/Time page

Device date format Device date Device time

If there are multiple devices operating in your system or network, it is important to synchronize their internal clocks. For example, it is only possible to identify and correctly evaluate simultaneous recordings when all devices are operating on the same time.

1. Enter the current date. Since the device time is controlled by the internal clock, it is not necessary to enter the day of the week – it is added automatically.
2. Enter the current time or click **Sync to PC** to apply the system time from your computer to the device.

Note:

It is important that the date/time is correct for recording. An incorrect date/time setting could prevent correct recording.

Device time zone

Select the time zone in which the system is located.

Daylight saving time

Set by Bosch VMS Management Server.

Time server IP address

Set by Bosch VMS Management Server.

Time server type

Set by Bosch VMS Management Server. Default setting is SNTP.

28.4 Installer / Initialization menu

28.4.1 Application variant

The camera has a choice of application variants that set up the camera for optimum performance in a specific environment. Select the application variant best suited to your installation.

The application variant must be selected before any other changes are made, as the camera reboots automatically and resets the factory defaults when the application variant is changed.

28.4.2 Base frame rate

Select the base frame rate for the camera.

Note:

Shutter times and frame rates, and the analog output (if present) are affected by this value.

28.4.3 Camera LED

Disable the **Camera LED** on the camera to switch it off.

28.4.4 Mirror image

Select **On** to output a mirror image of the camera picture.

28.4.5 Flip image

Select **On** to output an upside down camera image.

28.4.6 Menu button

Select **Disabled** to prevent access to the install wizard via the menu button on the camera itself.

28.4.7 Heater

Select **Auto** to let the camera determine when the heater should be switched on.

28.4.8 Reboot device

28.4.9 Factory defaults

Click **Defaults** to restore the factory defaults for the camera. A confirmation screen appears. Allow several seconds for the camera to optimize the picture after a reset.

28.4.10 Lens Wizard

Click **Lens Wizard...** to open a separate window which can be used to focus the camera lens (not for all cameras).

28.5 Privacy Masks page

Privacy masking is used to block a specific area of a scene from being viewed. Four privacy mask areas can be defined. The activated masked areas are filled with the selected pattern in live view.

1. Select the pattern to be used for all masks.
2. Check the box of the mask you wish to activate.

- Use the mouse to define the area for each of the masks.

**Notice!**

Draw the mask 10% larger than the object to ensure that the mask completely covers the object as the camera zooms in and out. Click the check box **Zoom threshold**.
Draw the mask at 50% optical zoom or less for improved masking performance.

Active masks

To activate a mask, select the appropriate check box.

Privacy masks

Select the privacy mask number. The preview window displays a gray rectangle in the scene.

Enabled

Select the check box to activate the privacy mask. After saving, the content inside the privacy mask is no longer visible in the preview. This area is blocked out from being viewing and recording.

Pattern

Pattern of the privacy mask.

Preview window

If necessary, change the size of the privacy mask area and move it to the position you want.

28.6**Recording Management page**

Active recordings are indicated by .

Point to the icon. Detailed information about the active recordings are displayed.

Recordings manually managed

The recordings are managed locally on this encoder. All relevant settings must be carried out manually. The encoder / IP camera acts as a live only device. It is not be removed from VRM automatically.

Recording 1 managed by VRM

The recordings of this encoder are managed by the VRM system.

Dual VRM

Recording 2 of this encoder is managed by a secondary VRM.

iSCSI Media tab

Click to display the available iSCSI storage connected to this encoder.

Local Media tab

Click to display the available local storage on this encoder.

Add

Click to add a storage device to the list of managed storage media.

Remove

Click to remove a storage device from the list of managed storage media.

See also

- *Configuring the storage media of an encoder, page 142*

28.7**Recording preferences page**

The **Recording preferences** page is displayed for each encoder. This page only appears if a device is assigned to a VRM system.

Primary target

Only visible if the **Recording preferences mode** list on the **Pool** page is set to **Failover**.
Select the entry for the required target.

Secondary target

Only visible if the **Recording preferences mode** list on the **Pool** page is set to **Failover** and if the **Secondary target usage** list is set to **On**.

Select the entry for the required target for configuring failover mode.

See also

- *Pool page, page 272*

28.8**Video Input page****Camera name stamping**

This field sets the position of the camera name overlay. It can be displayed at the **Top**, at the **Bottom**, or at a position of your choice that you can then specify using the **Custom** option. Or it can be set to **Off** for no overlay information.

1. Select the desired option from the list.
2. If you select the **Custom** option, additional fields are displayed where you can specify the exact position (**Position (XY)**).
3. In the **Position (XY)** fields, enter the values for the desired position.

Logo

Click **Choose File** to select a file. Heed the restrictions for file format, logo size, and color depth. **Click Upload** to load the file to the camera.

If no logo is selected, Configuration displays the message, “No file chosen.”

Logo position

Select the position for the logo on the OSD: Left or Right.

Select Off (the default value) to disable logo positioning.

Time stamping

This field sets the position of the time overlay. It can be displayed at the **Top**, at the **Bottom** or at a position of your choice that you can then specify using the **Custom** option. Or it can be set to **Off** for no overlay information.

1. Select the desired option from the list.
2. If you select the **Custom** option, additional fields are displayed where you can specify the exact position (**Position (XY)**).
3. In the **Position (XY)** fields, enter the values for the desired position.

If necessary, display milliseconds for **Time stamping**. This information can be useful for recorded video images; however, it does increase the processor's computing time. Select **Off** if displaying milliseconds is not needed.

Alarm mode stamping

Select **On** to display a text message overlay in the image in the event of an alarm. It can be displayed at a position of your choice that you can then specify using the **Custom** option. Or it can be set to **Off** for no overlay information.

1. Select the desired option from the list.
2. If you select the **Custom** option, additional fields are displayed where you can specify the exact position (**Position (XY)**).
3. In the **Position (XY)** fields, enter the values for the desired position.

Alarm message

Enter the message to be displayed in the image in the event of an alarm. The maximum text length is 31 characters.

Check this box to make the stamp on the image transparent.

Camera OSD

Select **On** to momentarily display camera response information, such as Digital Zoom, Iris open/close, and Focus near/far overlays in the image. Select **Off** to display no information.

1. Select the desired option from the list.
2. Specify the exact position (**Position (XY)**).
3. In the **Position (XY)** fields, enter the values for the desired position.

Title OSD

Select **On** to continuously display sector or shot title overlays in the image. Select **Momentary** to display sector or shot title overlays for a few seconds. OSD titles can be displayed at a position of your choice, or it can be set to **Off** for no overlay information.

1. Select the desired option from the list.
2. Specify the exact position (**Position (XY)**).
3. In the **Position (XY)** fields, enter the values for the desired position.

Video authentication

Select a method for verifying the integrity of the video in the **Video authentication** drop-down box.

If you select **Watermarking** all images are marked with an icon. The icon indicates if the sequence (live or saved) has been manipulated.

If you want to add a digital signature to the transmitted video images to ensure their integrity, select one of the cryptographic algorithms for this signature.

Enter the interval (in seconds) between insertions of the digital signature.

Signature intervals

Select the interval (in seconds) for the signature.

See also

- *Managing the verification of authenticity, page 146*

28.9 Picture settings - Scene mode

A scene mode is a collection of image parameters that are set in the camera when that particular mode is selected (installer menu settings are excluded). Several pre-defined modes are available for typical scenarios. After a mode has been selected, additional changes can be made through the user interface.

28.9.1 Current mode

Select the mode you wish to use from the drop-down menu.

28.9.2 Mode ID

The name of the selected mode is displayed.

28.9.3 Copy mode to

Select the mode from the drop-down menu to which you wish to copy the active mode.

28.9.4 Restore Mode Defaults

Click **Restore Mode Defaults** to restore the factory default modes. Confirm your decision.

28.9.5 Scene mode factory defaults

Outdoor

This mode covers most situations. It should be used in applications where the lighting changes from day to night. It takes into account sun highlights and street (sodium vapor) lighting.

Motion

This mode is used for monitoring the traffic movement on roads or parking lots. It can also be used for industrial applications where fast moving objects are to be monitored. Motion artifacts are minimized. This mode should be optimized for a sharp and detailed picture in color and black/white mode.

Low light

This mode is optimized for sufficient details at low light. It requires more bandwidth and can introduce motion judder.

BLC

This mode is optimized for scenes with people moving in front of a bright background.

Indoor

This mode is similar to the outdoor mode but it avoids the limitations imposed by the sun or street lighting.

Vibrant

This mode has enhanced contrast, sharpness and saturation.

28.9.6 Scene mode factory defaults

Outdoor

This mode covers most situations. It should be used in applications where the lighting changes from day to night. It takes into account sun highlights and street (sodium vapor) lighting.

Motion

This mode is used for monitoring the traffic movement on roads or parking lots. It can also be used for industrial applications where fast moving objects are to be monitored. Motion artifacts are minimized. This mode should be optimized for a sharp and detailed picture in color and black/white mode.

Low light

This mode is optimized for sufficient details at low light. It requires more bandwidth and can introduce motion judder.

Intelligent AE

This mode is optimized for scenes with people moving in front of a bright background.

Indoor

This mode is similar to the outdoor mode but it avoids the limitations imposed by the sun or street lighting.

Vibrant

This mode has enhanced contrast, sharpness and saturation.

28.9.7 Scene mode factory defaults

Indoor

This mode is similar to the outdoor mode but it avoids the limitations imposed by the sun or street lighting.

Outdoor

This mode covers most situations. It should be used in applications where the lighting changes from day to night. It takes into account sun highlights and street (sodium vapor) lighting.

Low light

This mode is optimized for sufficient details at low light. It requires more bandwidth and can introduce motion judder.

Night-optimized

This mode is optimized for sufficient details at low light. It requires more bandwidth and can introduce motion judder.

Low bit rate

This mode reduces the bitrate for installations with restricted network bandwidth and storage.

Intelligent AE

This mode is optimized for scenes with people moving in front of a bright background.

BLC

This mode is optimized for scenes with people moving in front of a bright background.

Vibrant

This mode has enhanced contrast, sharpness and saturation.

Sports and gaming

This mode is for high-speed capture, and improved color rendition and sharpness.

Motion

This mode is used for monitoring the traffic movement on roads or parking lots. It can also be used for industrial applications where fast moving objects are to be monitored. Motion artifacts are minimized. This mode should be optimized for a sharp and detailed picture in color and black/white mode.

Traffic

This mode is used for monitoring the traffic movement on roads or parking lots. It can also be used for industrial applications where fast moving objects are to be monitored. Motion artifacts are minimized. This mode should be optimized for a sharp and detailed picture in color and black/white.

Retail

This mode has improved color rendition and sharpness with reduced bandwidth requirements.

28.10 Picture settings - Color

Contrast (0...255)

Adjust the contrast with the slider from 0 to 255.

Saturation (0...255)

Adjust the color saturation with the slider from 0 to 255.

Brightness (0...255)

Adjust the brightness with the slider from 0 to 255.

28.10.1

White balance

- **Indoor:** Allows the camera to continually adjust for optimal color reproduction in an indoor environment.
- **Outdoor:** Allows the camera to continually adjust for optimal color reproduction in an outdoor environment.
- In **Manual** mode the Red, Green, and Blue gain can be manually set to a desired position.

Hold

Click **Hold** to put ATW on hold and save the current color settings. The mode changes to manual.

R-gain

In **Manual** white balance mode, adjust the red gain slider to offset the factory white point alignment (reducing red introduces more cyan).

G-gain

In **Manual** white balance mode, adjust the green gain slider to offset the factory white point alignment (reducing green introduces more magenta).

B-gain

In **Manual** white balance mode, adjust the blue gain slider to offset the factory white point alignment (reducing blue introduces more yellow).

Note:

It is only necessary to change the white point offset for special scene conditions.

Default

Click **Default** to set all video values to their factory setting.

28.10.2**White balance**

- **Basic auto** mode allows the camera to continually adjust for optimal color reproduction using an average reflectance method. This is useful for indoor light sources and for colored LED light illumination.
- **Standard auto** mode allows the camera to continually adjust for optimal color reproduction in an environment with natural light sources.
- Sodium vapor auto mode allows the camera to continually adjust for optimal color reproduction in an environment with sodium vapor light sources (street lighting).
- In **Manual** mode the Red, Green, and Blue gain can be manually set to a desired position.

Hold

Click **Hold** to put ATW on hold and save the current color settings. The mode changes to manual.

R-gain

In **Manual** white balance mode, adjust the red gain slider to offset the factory white point alignment (reducing red introduces more cyan).

G-gain

In **Manual** white balance mode, adjust the green gain slider to offset the factory white point alignment (reducing green introduces more magenta).

B-gain

In **Manual** white balance mode, adjust the blue gain slider to offset the factory white point alignment (reducing blue introduces more yellow).

Note:

It is only necessary to change the white point offset for special scene conditions.

Default

Click **Default** to set all video values to their factory setting.

28.10.3**White balance**

- **Standard auto** mode allows the camera to continually adjust for optimal color reproduction in an outdoor environment.
- In **Manual** mode the Red, Green, and Blue gain can be manually set to a desired position.

Hold

Click **Hold** to put ATW on hold and save the current color settings. The mode changes to manual.

R-gain

In **Manual** white balance mode, adjust the red gain slider to offset the factory white point alignment (reducing red introduces more cyan).

G-gain

In **Manual** white balance mode, adjust the green gain slider to offset the factory white point alignment (reducing green introduces more magenta).

B-gain

In **Manual** white balance mode, adjust the blue gain slider to offset the factory white point alignment (reducing blue introduces more yellow).

Note:

It is only necessary to change the white point offset for special scene conditions.

Default

Click **Default** to set all video values to their factory setting.

28.10.4**White balance**

- **Basic auto** mode allows the camera to continually adjust for optimal color reproduction using an average reflectance method. This is useful for indoor light sources and for colored LED light illumination.
- **Standard auto** mode allows the camera to continually adjust for optimal color reproduction in an environment with natural light sources.
- Sodium vapor auto mode allows the camera to continually adjust for optimal color reproduction in an environment with sodium vapor light sources (street lighting).
- **Dominant color auto** mode takes into account any dominant color in the image (for example, the green of a football pitch or of a gaming table) and uses this information to obtain a well balanced color reproduction.
- In **Manual** mode the Red, Green, and Blue gain can be manually set to a desired position.

Hold

Click **Hold** to put ATW on hold and save the current color settings. The mode changes to manual.

RGB-weighted white balance

In an auto mode, **RGB-weighted white balance** can be switched On or Off. When On, additional fine tuning of the automatic color reproduction can be made with the R, G and B weight sliders.

R-gain

In **Manual** white balance mode, adjust the red gain slider to offset the factory white point alignment (reducing red introduces more cyan).

G-gain

In **Manual** white balance mode, adjust the green gain slider to offset the factory white point alignment (reducing green introduces more magenta).

B-gain

In **Manual** white balance mode, adjust the blue gain slider to offset the factory white point alignment (reducing blue introduces more yellow).

Note:

It is only necessary to change the white point offset for special scene conditions.

Default

Click **Default** to set all video values to their factory setting.

28.11 Picture settings - ALC

28.11.1 ALC mode

Select the mode for automatic light-level control:

- Fluorescent 50 Hz
- Fluorescent 60 Hz
- Outdoor

28.11.2 ALC level

Adjust the video output level (-15 to 0 to +15).

Select the range within which the ALC will operate. A positive value is more useful for low-light conditions; a negative value is more useful for very bright conditions.

28.11.3 Saturation (av-pk)

The saturation (av-pk) slider configures the ALC level so that it controls mainly on scene average level (slider position -15) or on scene peak level (slider position +15). Scene peak level is useful for capturing images that contain car headlights.

28.11.4 Exposure/frame rate

Automatic exposure

Select to let the camera automatically set the optimum shutter speed. The camera tries to maintain the selected shutter speed as long as the light level of the scene permits.

- ▶ Select the minimum frame rate for automatic exposure. (The values available depend on the value set for the **Base frame rate** in the **Installer Menu**.)

Fixed exposure

Select to set a fixed shutter speed.

- ▶ Select the shutter speed for fixed exposure. (The values available depend on the value set for the ALC mode.)
- ▶ Select a default shutter speed. The default shutter improves the motion performance in auto exposure mode.

28.11.5 Day/night

Auto - the camera switches the IR cut-off filter on and off depending on the scene illumination level.

Monochrome - the IR cut-off filter is removed, giving full IR sensitivity.

Color - the camera always produces a color signal regardless of light levels.

Switch level

Set the video level at which the camera in **Auto** mode switches to monochrome operation (-15 to 0 to +15).

A low (negative) value means that the camera switches to monochrome at a lower light level. A high (positive) value means that the camera switches to monochrome at a higher light level.

Note:

To ensure stability when using IR illuminators, use the alarm interface for reliable Day/Night switching.

Switch level

Set the video level at which the camera in **Auto** mode switches to monochrome operation (-15 to 0 to +15).

A low (negative) value means that the camera switches to monochrome at a lower light level. A high (positive) value means that the camera switches to monochrome at a higher light level.

IR function

(only for cameras with built-in IR illuminators)

Select the control setting for IR illumination:

- **Auto:** the camera automatically switches the IR illumination.
- **On:** the IR illumination is always on.
- **Off:** the IR illumination is always off.

Intensity level

Set the intensity of the IR beam (0 to 30).

Day-to-night switchover

Adjust the slider to set the video level at which the camera in **Auto** mode switches from color to monochrome operation (-15 to +15).

A low (negative) value means that the camera switches to monochrome at a lower light level. A high (positive) value means that the camera switches to monochrome at a higher light level.

Night-to-day switchover

Adjust the slider to set the video level at which the camera in **Auto** mode switches from monochrome to color operation (-15 to +15).

A low (negative) value means that the camera switches to color at a lower light level. A high (positive) value means that the camera switches to color at a higher light level.

(The actual switch-over point might change automatically to avoid instable switching.)

Note:

To ensure stability when using IR illuminators, use the alarm interface for reliable Day/Night switching.

28.12

Encoder Regions page

1. Select one of the eight available regions from the drop-down box.
2. Use the mouse to define the area for that region by dragging the center or sides of the shaded window.
3. Select the encoder quality to be used for the defined area.
(Object and background quality levels are defined on the **Expert Settings** section of the **Encoder Profile** page.)
4. If required, select another region and repeat steps 2 and 3.
5. Click **Set** to apply the region settings.

Preview

Click  to open a viewing window where a 1:1 live image and the bit rate for the region settings can be previewed.

28.13

Camera page

AE-response speed

Select the speed of the response of auto exposure. Options are Super slow, Slow, Medium (default), Fast.

Backlight compensation

Optimizes the video level for the selected area of the image. Parts outside this area may be underexposed or overexposed. Select On to optimize the video level for the central area of the image. The default setting is Off.

Blue Gain

The blue gain adjustment offsets the factory white point alignment (reducing blue introduces more yellow). It is only necessary to change the white point offset for special scene conditions.

Color hue

The degree of color in the video image (HD only). Values range from -14° to 14°; the default is 8°.

Fixed Gain

Use the slide to select the desired number for fixed gain. The default is 2.

Gain control

Adjusts the automatic gain control (AGC). Automatically sets the gain to the lowest possible value needed to maintain a good picture.

- **AGC** (default): electronically brightens dark scenes, which may cause graininess in low light scenes.
- **Fixed**: no enhancement. This setting disables the Max. Gain Level option.
If you select this option, the camera makes the following changes automatically:
 - **Night Mode**: switches to Color
 - **Auto Iris**: switches to Constant

High Sensitivity

Adjusts the level of intensity or lux within the image (HD only). Select from Off or On.

Maximum Gain Level

Controls the maximum value the gain can have during AGC operation. To set the maximum gain level, choose from:

- **Normal**
- **Medium**
- **High** (default)

Night mode

Selects night mode (B/W) to enhance lighting in low light scenes. Select from the following options:

- **Monochrome**: Forces the camera to stay in Night Mode and transmit monochrome images.
- **Color**: The camera does not switch to Night Mode regardless of ambient light conditions.
- **Auto** (default): The camera switches out of Night Mode after the ambient light level reaches a pre-defined threshold.

Night mode threshold

Adjusts the level of light at which the camera automatically switches out of night mode (B/W) operation. Select a value between 10 and 55 (in increments of 5; default 30). The lower the value, the earlier the camera will switch to color mode.

Noise Reduction

Turns on the 2D and 3D noise reduction feature.

Noise Reduction Level

Adjusts the noise level to the appropriate level for shooting conditions. Select a value between 1 and 5.

Red Gain

The red gain adjustment offsets the factory white point alignment (reducing red introduces more cyan).

Saturation

The percentage of light or color in the video image (HD only). Values range from 60% to 200%; the default is 110%.

Sharpness

Adjusts the sharpness of the picture. To set the sharpness, use the slider to select a number. The default is 12.

Current mode**Shutter**

Adjusts the electronic shutter speed (AES). Controls the time period for which light is gathered by the collecting device. The default setting is 1/60 second for NTSC and 1/50 for PAL cameras. The range of settings is from 1/1 to 1/10000.

Shutter Mode

- **Fixed:** The shutter mode is fixed to a selectable shutter speed.
- **Automatic exposure:** increases camera sensitivity by increasing the integration time on the camera. This is accomplished by integrating the signal from a number of consecutive video frames to reduce signal noise.

If you select this option, the camera disables **Shutter** automatically.

Stabilization

This feature is ideal for cameras mounted on a pole or mast, or on another location that shakes frequently.

Select On to activate the video stabilization feature (if available on your camera) that reduces camera shake in both the vertical and horizontal axis. The camera compensates for the movement of the image by up to 2% of the image size.

Select Auto to activate the feature automatically when the camera detects vibration.

Select Off to deactivate the feature.

Note: This feature is not available on 20x models.

White Balance

Adjusts the color settings to maintain the quality of the white areas of the image.

28.13.1**ALC****ALC mode**

Select the mode for automatic light-level control:

- Fluorescent 50 Hz
- Fluorescent 60 Hz
- Outdoor

ALC level

Adjust the video output level (-15 to 0 to +15).

Select the range within which the ALC will operate. A positive value is more useful for low-light conditions; a negative value is more useful for very bright conditions.

The saturation (av-pk) slider configures the ALC level so that it controls mainly on scene average level (slider position -15) or on scene peak level (slider position +15). Scene peak level is useful for capturing images that contain car headlights.

Exposure**Automatic exposure**

Select to let the camera automatically set the optimum shutter speed. The camera tries to maintain the selected shutter speed as long as the light level of the scene permits.

- ▶ Select the minimum frame rate for automatic exposure. (The values available depend on the value set for the **Base frame rate** in the **Installer Menu**.)

Fixed exposure

Select to set a fixed shutter speed.

- ▶ Select the shutter speed for fixed exposure. (The values available depend on the value set for the ALC mode.)
- ▶ Select a default shutter speed. The default shutter improves the motion performance in auto exposure mode.

Day/night

Auto - the camera switches the IR cut-off filter on and off depending on the scene illumination level.

Monochrome - the IR cut-off filter is removed, giving full IR sensitivity.

Color - the camera always produces a color signal regardless of light levels.

Note:

To ensure stability when using IR illuminators, use the alarm interface for reliable Day/Night switching.

Night-to-day switchover

Adjust the slider to set the video level at which the camera in **Auto** mode switches from monochrome to color operation (-15 to +15).

A low (negative) value means that the camera switches to color at a lower light level. A high (positive) value means that the camera switches to color at a higher light level.

(The actual switch-over point might change automatically to avoid instable switching.)

Day-to-night switchover

Adjust the slider to set the video level at which the camera in **Auto** mode switches from color to monochrome operation (-15 to +15).

A low (negative) value means that the camera switches to monochrome at a lower light level. A high (positive) value means that the camera switches to monochrome at a higher light level.

IR function

(only for cameras with built-in IR illuminators)

Select the control setting for IR illumination:

- **Auto:** the camera automatically switches the IR illumination.
- **On:** the IR illumination is always on.
- **Off:** the IR illumination is always off.

Intensity level

Set the intensity of the IR beam (0 to 30).

28.13.2**Scene mode**

A scene mode is a collection of image parameters that are set in the camera when that particular mode is selected (installer menu settings are excluded). Several pre-defined modes are available for typical scenarios. After a mode has been selected, additional changes can be made through the user interface.

Current mode

Select the mode you wish to use from the drop-down menu.

Mode ID

The name of the selected mode is displayed.

28.13.3**Scene Mode Scheduler**

The scene mode scheduler is used to determine which scene mode should be used during the day and which scene mode should be used during the night.

1. Select the mode you wish to use during the day from **Marked range** drop-down box.
2. Select the mode you wish to use during the night from **Unmarked range** drop-down box.
3. Use the two slider buttons to set the **Time ranges**.

Outdoor

This mode covers most situations. It should be used in applications where the lighting changes from day to night. It takes into account sun highlights and street (sodium vapor) lighting.

Vibrant

This mode has enhanced contrast, sharpness and saturation.

Motion

This mode is used for monitoring the traffic movement on roads or parking lots. It can also be used for industrial applications where fast moving objects are to be monitored. Motion artifacts are minimized. This mode should be optimized for a sharp and detailed picture in color and black/white mode.

Low light

This mode is optimized for sufficient details at low light. It requires more bandwidth and can introduce motion judder.

Intelligent AE

This mode is optimized for scenes with people moving in front of a bright background.

Indoor

This mode is similar to the outdoor mode but it avoids the limitations imposed by the sun or street lighting.

BLC

This mode is optimized for scenes with people moving in front of a bright background.

28.13.4**WDR**

Select **Auto** for automatic Wide Dynamic Range (WDR); select **Off** to disable WDR.

Note:

WDR can only be active if Auto exposure is selected, and there is a match between the base frame rate selected in the installer menu and the ALC fluorescent mode frequency. If there is a conflict, a pop-up window will suggest a solution and adjust the appropriate settings.

28.13.5**Sharpness level**

The slider adjusts the sharpness level between -15 and +15. Zero position of the slider corresponds to the factory default level.

A low (negative) value makes the picture less sharp. Increasing sharpness brings out more detail. Extra sharpness can enhance the details of license plates, facial features and the edges of certain surfaces but can increase bandwidth requirements.

28.13.6**Backlight Compensation**

Select **Off** to switch off backlight compensation.

Select **On** to capture details in high-contrast and extremely bright-dark conditions.

Select **Intelligent AE** to capture object detail in scenes with people moving in front of a bright background

28.13.7**Contrast enhancement**

Select **On** to increase the contrast in low contrast conditions.

28.13.8

Intelligent DNR

Select **On** to activate intelligent Dynamic Noise Reduction (DNR) which reduces noise based on motion and light levels.

Temporal noise filtering

Adjusts the **Temporal noise filtering** level between -15 and +15. The higher the value, the more noise filtering.

Spatial noise filtering

Adjusts the **Spatial noise filtering** level between -15 and +15. The higher the value, the more noise filtering.

28.13.9

Intelligent defog

Select **Intelligent defog** to activate the automatic intelligent defog feature. This feature continuously adjusts image parameters to provide the best picture possible under foggy or misty conditions.

28.14

Lens page

28.14.1

Focus

Autofocus

Continuously adjusts the lens automatically to the correct focus for the sharpest picture.

- **One push** (default): Activates the Auto Focus feature after the camera stops moving. Once focused, Auto Focus is inactive until the camera is moved again.
- **Auto focus**: Auto Focus is always active.
- **Manual**: Auto Focus is inactive.

Focus polarity

- **Normal** (default): Focus controls operate normally.
- **Reverse**: Focus controls are reversed.

Focus speed

Controls how fast the Auto focus will readjust when the focus becomes blurred.

28.14.2

Iris

Auto iris

Automatically adjusts the lens to allow the correct illumination of the camera sensor. This type of lens is recommended for use when there are low light or changing light conditions.

- **Constant** (default): Camera constantly adjusts to varying light conditions. If you select this option, for example the AutoDome Junior HD makes the following changes automatically:
 - **Gain control**: switches to AGC
 - **Shutter mode**: switches to Normal
- **Manual**: Camera must be manually adjusted to compensate for varying light conditions.

Iris polarity

Capability to reverse the operation of the iris button on the controller.

- **Normal** (default): Iris controls operate normally.
- **Reverse**: Iris controls are reversed.

Auto iris level

Increases or decreases brightness according to the amount of light. Type a value between 1 and 15, inclusive. The default setting is 8.

Iris speed

Controls how fast the Iris will adjust the opening according to the illumination of the scene. Type a value between 1 and 10, inclusive. The default setting is 5.

28.14.3**Zoom****Maximum zoom speed**

Controls the zoom speed. Default setting: **Fast**

Zoom polarity

Capability to reverse the operation of the zoom button on the controller.

- **Normal** (default): Zoom controls operate normally.
- **Reverse**: Zoom controls are reversed.

Digital zoom

Digital zoom is a method of decreasing (narrowing) the apparent angle of view of a digital video image. It is accomplished electronically, without any adjustment of the camera's optics, and no optical resolution is gained in the process.

- **Off** (default): Enables the Digital Zoom feature.
- **On**: Disables the Digital Zoom feature.

28.15**PTZ page****Auto pan speed**

Continuously pans the camera at a speed between right and left limit settings. Type a value between 1 and 60 (expressed in degrees), inclusive. The default setting is 30.

Inactivity

Selects the time period the dome must be not controlled until the inactivity event will be executed.

- **Off** (default): Camera remains on a current scene indefinitely.
- **Scene 1**: Camera returns to Preset 1.
- **Previous Aux**: Camera returns to the previous activity.

Inactivity period

Determines the behavior of the dome when the control for dome is inactive. Select a time period from the pull-down list (3 sec. - 10 min.). The default setting is 2 minutes.

Auto pivot

The Auto Pivot tilts the camera through the vertical position as the camera is rotated to maintain the correct orientation of the image.

Set the Auto Pivot to **On** (default) to automatically rotate the camera 180° when following a subject traveling directly beneath the camera. To disable this feature, click **Off**.

Freeze frame

Select **On** (default) to freeze the image while the camera moves to a predetermined scene position.

Tilt up limit

Click **Set**, to set the upper tilt limit of the camera.

Tilt limits

Click **Reset** to clear the upper tilt limit.

28.16**Prepositions and Tours page**

Allows you to define the individual scenes and a preposition tour comprised of the defined scenes.

To add scenes:

Click .

To delete scenes:

Select the scene, then click .

To overwrite (save) scenes:

Click .

To view scenes:

Select the scene, then click .

Include in standard tour (marked with *)

Select the check box if the scene should be part of the preposition tour. The asterisk (*) on the left of the scene name indicates this.

28.17 Sectors page

Sector

The pan capability (for example for the AutoDome Junior HD camera) is 360° and is divided into eight equal sectors. This allows you to apply a title for each sector and to designate any sectors as a Blanked Sector.

To define a title for sectors:

1. Place the pointer in the input box to the right of the sector number.
2. Type a title for the sector, up to 20 characters long.
3. To blank the sector, click the check box to the right of the sector title.

28.18 Misc page

Address

Allows the appropriate device to be operated via the numerical address in the control system. Type a number between 0000 and 9999, inclusive, to identify the camera.

28.19 Logs page

This page allows you to display and to save log files.

Download

Click to obtain the log file information. The log files are displayed in the overview.

Save

Click to save the log files.

28.20 Audio page

This function allows you to set the gain of the audio signals to suit your specific requirements. The current video image is shown in the small window next to the slide controls to help you check the selected audio source and improve assignments. Your changes are effective immediately.

The numbering of the audio inputs follows the labeling on the device and the assignment to the respective video inputs. The assignment cannot be changed for Web browser connections.

Audio

The audio signals are sent in a separate data stream parallel to the video data, and so increase the network load. The audio data are encoded according to G.711 and require an additional bandwidth of approximately 80 kbps for each connection.

- **On:** Transmits audio data.
- **Off:** No transmission of audio data.

Line In 1 - Line In 4

Enter the value of the gain of the audio signal. Make sure that the display of the slider  remains green.

Line Out

Enter the value of the gain. Make sure that the display of the slider  remains green.

Microphone (MIC)

Enter the value of the gain for the microphone.

Line Out/Speaker (SPK)

Enter the value of the gain of the line and the loudspeaker.

Recording format

Select a format for audio recording.

G.711: default value.

L16: Select L16 if you want better audio quality with higher sampling rates. This requires approximately eight times the G.711 bandwidth.

28.21**Relay page**

This function allows you to configure the switching behavior of the relay outputs.

You can configure the switching behavior of the relay outputs. For each relay, you can specify an open switch relay (normally closed contact) or a closed switch relay (normally open contact).

You can also specify whether an output should operate as a bistable or monostable relay. In bistable mode, the triggered state of the relay is maintained. In monostable mode, you can set the time after which the relay returns to the idle state.

You can select different events that automatically activate an output. It is possible, for example, to turn on a floodlight by triggering a motion alarm and then turning the light off again when the alarm has stopped.

Idle state

Select **Open** if you want the relay to operate as an NO contact, or select **Closed** if the relay is to operate as an NC contact.

Operating mode

Select an operating mode for the relay.

For example, if you want an alarm-activated lamp to stay on after the alarm ends, select the **Bistable** entry. If you wish an alarm-activated siren to sound for ten seconds, select the 10 s entry.

Relay follows

If required, select a specific event that will trigger the relay. The following events are possible triggers:

Off: Relay is not triggered by events

Connection: Trigger whenever a connection is made

Video alarm: Trigger by interruption of the video signal at the corresponding input

Motion alarm: Trigger by motion alarm at the corresponding input, as configured on the VCA page.

Local input: Trigger by the corresponding external alarm input

Remote input: Trigger by remote station's corresponding switching contact (only if a connection exists)

Note:

The numbers in the lists of selectable events relate to the corresponding connections on the device, Video alarm 1, for example to the Video In 1 connection.

Trigger output

Click the relay button to trigger the relay manually (for example, for testing purposes or to activate a door opener).

The relay button displays the state of each relay.

Red: Relay is activated.

Blue: Relay is not activated.

28.22

Periphery page

28.22.1

COM1

This function allows you to configure the serial interface parameters according to your requirements.

If the device is working in multicast mode, the first remote location to establish a video connection to the device is also assigned the transparent data connection. However, after about 15 seconds of inactivity the data connection is automatically terminated and another remote location can exchange transparent data with the device.

Serial port function

Select a controllable device from the list. Select Transparent data to transmit transparent data via the serial port. Select Terminal to operate the device from a terminal.

After selecting a device, the remaining parameters in the window are set automatically and should not be changed.

Baud rate (bps)

Select the value for the transmission rate.

Stop bits

Select the number of stop bits per character.

Parity check

Select the type of parity check.

Interface mode

Select the protocol for the serial interface.

28.23

VCA page

The device contains an integrated Video Content Analysis (VCA), which can detect and analyze changes in the signal using image processing algorithms. Such changes are triggered by motion in the camera's field of view.

If there is not enough computing power, priority is given to live images and recordings. This can lead to impairment of the VCA system. Observe the processor load and optimize the settings of the device or the VCA settings, if necessary.

You can configure profiles with different VCA configurations. You can save profiles on your computer's hard drive and load saved profiles from there. This can be useful if you want to test a number of different configurations. Save a functioning configuration and test new settings. You can use the saved configuration to restore the original settings at any time.

- ▶ Select a VCA profile and change the settings if necessary.

To rename the VCA profile:

- ▶ Click . The **Edit** dialog box is displayed. Type the new name, and then click **OK**.

Alarm status

Displays the current alarm state to check the effects of your settings immediately.

Aggregation time [s]

Set an aggregation time of between 0 and 20 seconds. The aggregation time always starts when an alarm event occurs. It extends the alarm event by the value set. This prevents alarm events that occur in quick succession from triggering several alarms and successive events in a rapid sequence. No further alarm is triggered during the aggregation time.

The post-alarm time set for alarm recordings only starts once the aggregation time has expired.

Analysis type

Select the required analysis type from the drop-down menu. Different analysis types offer varying levels of control over alarm rules, object filters and tracking modes.

Refer to the VCA documentation for more information on using these.

Motion detector

See *Motion detector (MOTION+ only)*, page 312.

Motion detection is available for the Motion+ analysis type. For the detector to function, the following conditions must be met:

- Analysis must be activated.
- At least one sensor field must be activated.
- The individual parameters must be configured to suit the operating environment and the desired responses.
- The sensitivity must be set to a value greater than zero.

Note:

Reflections of light (from glass surfaces, etc.), lights switching on and off, or changes in the light level caused by cloud movement on a sunny day can trigger unintended responses from the motion detector and generate false alarms. Run a series of tests at different times of the day and night to ensure that the video sensor is operating as intended. For indoor surveillance, ensure constant lighting of the areas during the day and at night.

Tamper detection

See *Tamper detection*, page 314

Load...

Click to load a saved profile. The **Open** dialog box is displayed. Select the filename of the profile you want to load, and then click **OK**.

Save...

Click to save the profile settings to another file. The **Save** dialog box is displayed. Type the filename, select the folder where to save the file, and then click **OK**.

Default

Click to return all settings to their default values.

28.23.1**Motion detector (MOTION+ only)****Motion detector**

For the detector to function, the following conditions must be met:

- Analysis must be activated.
- At least one sensor field must be activated.
- The individual parameters must be configured to suit the operating environment and the desired responses.
- The sensitivity must be set to a value greater than zero.

**Caution!**

Reflections of light (off glass surfaces, etc.), switching lights on or off or changes in the light level caused by cloud movement on a sunny day can trigger unintended responses from the motion detector and generate false alarms. Run a series of tests at different times of the day and night to ensure that the video sensor is operating as intended.

For indoor surveillance, ensure constant lighting of the areas during the day and at night.

Debounce time 1 s

The debounce time prevents very brief alarm events from triggering individual alarms. If the **Debounce time 1 s** option is activated, an alarm event must last at least 1 second to trigger an alarm.

Selecting the area

Select the areas of the image to be monitored by the motion detector. The video image is subdivided into square sensor fields. Activate or deactivate each of these fields individually. To exclude particular regions of the camera's field of view from monitoring due to continuous movement (by a tree in the wind, for example), the relevant fields can be deactivated.

1. Click **Mask...** to configure the sensor fields. A new window opens.
2. If necessary, click **Clear All** first to clear the current selection (fields marked red).
3. Left-click the fields to be activated. Activated fields are marked red.
4. If necessary, click **Select All** to select the entire video- frame for monitoring.
5. Right-click any fields to deactivate.
6. Click **OK** to save the configuration.
7. Click the close button (**X**) in the window title bar to close the window without saving the changes.

Sensitivity

Sensitivity is available for the Motion+ analysis type. The basic sensitivity of the motion detector can be adjusted for the environmental conditions to which the camera is subject. The sensor reacts to variations in the brightness of the video image. The darker the observation area, the higher the value that must be selected.

Minimum object size

Specify the number of sensor fields that a moving object must cover to generate an alarm. This setting prevents objects that are too small from triggering an alarm. A minimum value of 4 is recommended. This value corresponds to four sensor fields.

28.23.2**Select Area dialog box**

This dialog box displays the camera image. Within this window you can activate the areas of the image to be monitored.

To activate an area:

In the camera image, drag over the area you want to activate. Activated areas are marked yellow.

To deactivate an area:

In the camera image, press the SHIFT key and click the area you want to deactivate.

To obtain commands in the window:

To see the commands for activating or deactivating the areas, right-click anywhere in the window. The following commands are available:

- **Undo**
Undoes the last command.
- **Set All**

- Activates the entire camera image.
- **Clear All**
Deactivates the entire camera image.
- **Tool**
Defines the shape of the mouse pointer.
- **Settings**
Displays the Editor Settings dialog box. In this dialog box you can change the sensitivity and the minimum object size.

28.23.3

Tamper detection

You can detect tampering of cameras and video cables by means of various options. Run a series of tests at different times of the day and night to ensure that the video sensor is operating as intended.

The options for tamper detection can only be set for fixed cameras. Dome cameras or other motorized cameras cannot be protected in this manner as the movement of the camera itself causes changes in the video image that are too great.

Scene too bright

Activate this function if tampering associated with exposure to extreme light (for instance, shining a flashlight directly on the objective) should trigger an alarm. The average brightness of the scene provides a basis for recognition.

Global change (slider)

Set how large the global change in the video image must be for an alarm to be triggered. This setting is independent of the sensor fields selected under **Mask...** Set a high value if fewer sensor fields need to change to trigger an alarm. With a low value, it is necessary for changes to occur simultaneously in a large number of sensor fields to trigger an alarm. This option allows detection, independently of motion alarms, manipulation of the orientation or location of a camera resulting from turning the camera mount bracket, for example.

Scene too dark

Activate this function if tampering associated with covering the objective (for instance, by spraying paint on it) should trigger an alarm. The average brightness of the scene provides a basis for recognition.

Scene too noisy

Activate this function if tampering associated with EMC interference (noisy scene as the result of a strong interference signal in the vicinity of the video lines) should trigger an alarm.

Reference check

Save a reference image that can be continuously compared with the current video image. If the current video image in the marked areas differs from the reference image, an alarm is triggered. This detects tampering that would otherwise not be detected, for example, if the camera is turned.

1. Click **Reference** to save the currently visible video image as a reference.
2. Click **Mask...** and select the areas in the reference image that are to be monitored.
3. Check the box **Reference check** to activate the on-going check. The stored reference image is displayed in black and white below the current video image, and the selected areas are marked in yellow.
4. Select the **Disappearing edges** or **Appearing edges** option to specify the reference check once again.

Trigger delay [s]

Set delayed alarm triggering here. The alarm is only triggered after a set time interval in seconds has elapsed and then only if the triggering condition still exists. If the original condition has been restored before this time interval elapses, the alarm is not triggered. This avoids false alarms triggered by short-term changes, for example, cleaning activities in the direct field of vision of the camera.

Sensitivity

The basic sensitivity of the tamper detection can be adjusted for the environmental conditions to which the camera is subject. The algorithm reacts to the differences between the reference image and the current video image. The darker the observation area, the higher the value that must be selected.

Appearing edges

Select this option if the selected area of the reference image includes a largely homogenous surface. If structures appear in this area, then an alarm is triggered.

Disappearing edges

The area selected in the reference image should contain a prominent structure. If this structure is concealed or moved, the reference check triggers an alarm. If the selected area is too homogenous, so that concealing and moving the structure would not trigger an alarm, then an alarm is triggered immediately to indicate the inadequate reference image.

See also

– *Select Area dialog box, page 313*

28.24**Network Access page**

The settings on this page are used to integrate the device into an existing network.

DHCP

If the network has a DHCP server for the dynamic assignment of IP addresses, select **On** or **On plus Link-Local** to automatically accept the DHCP-assigned IP address.

If no DHCP server is available select **On plus Link-Local** to automatically assign a Link-Local (Auto-IP) address.

For certain applications, the DHCP server must support the fixed assignment between IP address and MAC address, and must be appropriately set up so that, once an IP address is assigned, it is retained each time the system is rebooted.

Subnet mask

Enter the appropriate subnet mask for the set IP address.

Gateway address

For the device to establish a connection to a remote location in a different subnet, enter the IP address of the gateway here. Otherwise, this field can remain empty (0.0.0.0).

Prefix length

Enter the appropriate prefix length for the set IP address.

DNS server address

The device is easier to access if it is listed on a DNS server. For example, to establish an Internet connection to the camera, it is sufficient to enter the name given to the device on the DNS server as a URL in the browser. Enter the DNS server's IP address. Servers are supported for secure and dynamic DNS.

Video transmission

If the device is used behind a firewall, TCP (Port 80) should be selected as the transmission protocol. For use in a local network, choose UDP.

Multicast operation is only possible with the UDP protocol. The TCP protocol does not support multicast connections.

TCP rate control

Activate this option if you want to allow Adaptive Bit Rate encoding.

HTTP browser port

Select a different HTTP browser port from the list if required. The default HTTP port is 80. To limit connection to HTTPS, deactivate the HTTP port. To do this, activate the **Off** option.

HTTPS browser port

To limit browser access to encrypted connections, choose an HTTPS port from the list. The standard HTTPS port is 443. Select the **Off** option to deactivate HTTPS ports and limit connections to unencrypted ports.

The camera uses the TLS 1.0 protocol. Ensure that the browser has been configured to support this protocol. Also ensure that Java application support is activated (in the Java Plug-in Control Panel of the Windows Control Panel).

To limit connections to SSL encryption, set the **Off** option in the HTTP browser port, the RCP+ port, and Telnet support. This deactivates all unencrypted connections allowing connections on the HTTPS port only.

Configure and activate encryption for media data (video, audio, metadata) on the **Encryption** page.

HSTS

Select **On** to use the web security policy HTTP Strict Transport Security (HSTS) to provide secure connections.

RCP+ port 1756

Activating RCP+ port 1756 allows unencrypted connections on this port. To allow only encrypted connections, set the **Off** option to deactivate the port.

Telnet support

Activating Telnet support allows unencrypted connections on this port. To allow only encrypted connections, set the **Off** option to deactivate telnet support, making telnet connections impossible.

Interface mode ETH 1 - Interface mode ETH 2 - Interface mode ETH 3

If necessary, select the Ethernet link type for interface ETH. Depending on the device connected, it may be necessary to select a special operation type.

Network MSS [Byte]

Set the maximum segment size for the IP packet's user data here. This gives the option to adjust the size of the data packets to the network environment and to optimize data transmission. In UDP mode, comply with the MTU value set below.

iSCSI MSS [Byte]

Enter the Maximum Segment Size (MSS) for a connection to the iSCSI system.

The maximum segment size for a connection to the iSCSI system can be higher than for the other data traffic via the network. The size depends on the network structure. A higher value is only useful if the iSCSI system is located in the same subnet as the device.

MAC address

Displays the MAC address.

28.24.1

JPEG posting

This function allows you to save individual JPEG images on an FTP server at specific intervals. Then, retrieve these images at a later date to reconstruct alarm events, if required.

Image size

Select the resolution for the JPEG images.

File name

Select how file names are created for the individual images that are transmitted.

- **Overwrite**

The same file name is always used. An existing file is overwritten by the current file.

- **Increment**

A number from 000 to 255 is added to the file name and automatically incremented by 1. When the number reaches 255, the number starts again from 000.

- **Date/time suffix**

The date and time are automatically added to the file name. Ensure that the date and time of the device are always set correctly. For example, the file snap011008_114530.jpg was stored on October 1, 2008 at 11.45 and 30 seconds.

Posting interval (s; 0 = Off)

Enter the interval in seconds at which the images is sent to an FTP server. Enter zero for no images to be sent.

28.24.2

FTP server

FTP server IP address

Type the IP address of the FTP server on which to save the JPEG images.

FTP server login

Type your login name for the FTP server.

FTP server password

Type the password for the FTP server.

Path on FTP server

Type the exact path where to save the images on the FTP server.

Post JPEG from camera

Select the check box to activate the camera input for the JPEG image. The numbering follows the labeling of the video inputs on the device.

Max. bit rate

You can limit the bit rate for FTP posting.

28.25

DynDNS

28.25.1

Enable DynDNS

A dynamic Domain Name Service (DNS) allows you to select the unit via the Internet using a host name, without having to know the current IP address of the unit. You can enable this service here. To do this, you must have an account with one of the dynamic DNS providers and you must register the required host name for the unit on that site.

Note:

For information about the service, registration process and available host names refer to the provider.

28.25.2**Provider**

Select your dynamic DNS Provider from the drop-down list.

28.25.3**Host name**

Enter the host name registered for the unit.

28.25.4**User name**

Enter the user name you registered.

28.25.5**Password**

Enter the password you registered.

28.25.6**Force registration now**

Force the registration by transferring the IP address to the DynDNS server. Entries that change frequently are not provided in the Domain Name System. It is a good idea to force the registration when setting up the device for the first time. Only use this function when necessary and no more than once a day, to avoid the possibility of being blocked by the service provider. To transfer the IP address of the device, click the **Register** button.

28.25.7**Status**

The status of the DynDNS function is displayed here for information purposes; these settings cannot be changed.

28.26**Network Management****28.26.1****SNMP**

The camera supports the SNMP V1 (Simple Network Management Protocol) for managing and monitoring network components, and can send SNMP messages (traps) to IP addresses. It supports SNMP MIB II in the unified code.

If **On** is selected for the SNMP parameter and a SNMP host address is not entered, the device does not send the traps automatically and will only reply to SNMP requests. If one or two SNMP host addresses are entered, SNMP traps are sent automatically. Select **Off** to deactivate the SNMP function.

SNMP host addresses

To send SNMP traps automatically, enter the IP address of one or two target devices here.

SNMP traps

To choose which traps are sent:

1. Click **Select**. A dialog box appears.
2. Click the check boxes of the appropriate traps.
3. Click **Set** to close the window and send all of the checked traps.

28.26.2**UPnP**

Select **On** to activate UPnP communication. Select **Off** to deactivate it.

When the Universal Plug-and-Play (UPnP) function is activated, the unit responds to requests from the network and is automatically registered on the requesting computers as a new network device. This function should not be used in large installations due to the large number of registration notifications.

Note:

To use the UPnP function on a Windows computer, both the Universal Plug-and-Play Device Host and the SSDP Discovery Service must be activated.

28.26.3 Quality of Service

The priority of the different data channels can be set by defining the DiffServ Code Point (DSCP). Enter a number between 0 and 252 as a multiple of four. For alarm video you can set a higher priority than for regular video and you can define a Post Alarm Time over which this priority is maintained.

28.27 Advanced page

28.27.1 SNMP

The device supports the SNMP V2 (Simple Network Management Protocol) for managing and monitoring network components, and can send SNMP messages (traps) to IP addresses. The device supports SNMP MIB II in the unified code.

SNMP

Select **On** to activate the SNMP function.

1. SNMP host address / 2. SNMP host address

Type the IP addresses of one or two target units. The device (for example encoder, camera) sends SNMP traps automatically to the target units.

If you do not enter IP addresses, the device only replies to SNMP requests and does not send SNMP traps to the target units.

SNMP traps

Allows you to select which traps the device sends to the target units. To do this, click **Select**. The **SNMP traps** dialog box is displayed.

SNMP traps dialog box

Select the check boxes of the appropriate traps, and then click **OK**.

28.27.2 802.1x

IEEE 802.1x allows you to communicate with the device if a RADIUS server is used in a network.

Authentication

Select **On** to activate 802.1x.

Identity

Type the user name that the RADIUS server uses for identifying the device.

Password

Type the password that the RADIUS server uses for identifying the device.

28.27.3 RTSP

RTSP port

If necessary, select a different port for the exchange of the RTSP data. The default port is 554.

Off disables the RTSP function.

28.27.4 UPnP

You can activate the universal plug and play function (UPnP). When activated the camera reacts on requests from the network and will be registered automatically as a new network device on the inquiring computers. The access to the camera is then possible using the Windows file explorer, and without knowledge of the camera's IP address.

Note:

In order to use the UPnP function on a computer with Windows XP or Windows Vista, the Universal Plug and Play Device Host and the SSDP Discovery services must be activated.

28.27.5

TCP metadata input

This feature allows a device to receive data from an external TCP sender, for example an ATM or POS device, and store it as metadata.

TCP port

Select the port for TCP communication. Select **Off** to deactivate the TCP metadata function.

Sender IP address

Type the IP address of the TCP metadata sender here.

28.28

Multicast page

In addition to a 1:1 connection between an encoder and a single receiver (unicast), the device enables multiple receivers to receive the video signal from an encoder simultaneously.

The device either duplicates the data stream itself and then distributes it to multiple receivers (Multi-unicast) or it sends a single data stream to the network, where the data stream is simultaneously distributed to multiple receivers in a defined group (Multicast). You can enter a dedicated multicast address and port for each stream.

The prerequisite for multicast operation is a multicast-capable network that uses the UDP and IGMP protocols. Other group management protocols are not supported. The TCP protocol does not support multicast connections.

A special IP address (class D address) must be configured for multicast operation in a multicast-enabled network. The network must support group IP addresses and the Internet Group Management Protocol (IGMP V2). The address range is from 225.0.0.0 to 239.255.255.255. The multicast address can be the same for multiple streams. However, it is then necessary to use a different port in each case so that multiple data streams are not sent simultaneously using the same port and the same multicast address.

Note: The settings must be done for each encoder (video input) and for each stream individually. The numbering follows the labeling of the video inputs on the device.

Enable

To enable simultaneous data reception on several receivers you need to activate the multicast function. To do this, select the check box. Then enter the multicast address.

Multicast Address

Enter a valid multicast address for each stream from the relevant encoder (video input) to be operated in multicast mode (duplication of the data streams in the network).

With the setting 0.0.0.0 the encoder for the relevant stream operates in multi-unicast mode (copying of data streams in the device). The device supports multi-unicast connections for up to five simultaneously connected receivers.

Note: Duplication of data places a heavy demand on the device and can lead to impairment of the image quality under certain circumstances.

Port

Assign a different port to each data stream if there are simultaneous data streams at the same multicast address.

Enter the port address of the required stream here.

Streaming

Select the check box to activate multicast streaming mode for the relevant stream. The device even streams multicast data if no connection is active.

For normal multicast operation, streaming is typically not required.

Packet TTL (only for Dinion IP, Gen4 and FlexiDome)

Enter a value to specify how long the multicast data packets are active on the network. If multicast is to be run via a router, the value must be greater than 1.

28.29**Accounts**

Four separate accounts can be defined for posting and recording export.

Type

Select either FTP or Dropbox for the account type.

Before using a Dropbox account ensure that the time settings of the device have been correctly synchronized.

Account name

Enter an account name to be shown as the target name.

FTP server IP address

For an FTP server, enter the IP address.

FTP server login

Enter your login name for the account server.

FTP server password

Enter the password that gives access to the account server. Click Check to confirm that it is correct.

Path on FTP server

Enter an exact path to post the images on the account server. Click Browse... to browse to the required path.

Maximum bit rate

Enter the maximum bit rate in kbps that will be allowed when communicating with the account.

28.30**IP v4 Filter**

To restrict the range of IP addresses within which you can actively connect to the device, fill-in an IP address and mask. Two ranges can be defined.

- ▶ Click **Set** and confirm to restrict access.

If either of these ranges are set, no IP V6 addresses are allowed to actively connect to the device.

The device itself may initiate a connection (for example, to send an alarm) outside the defined ranges if it is configured to do so.

28.31**Licenses page**

You can enter the activation key to release additional functions or software modules.

**Notice!**

The activation key cannot be deactivated again and is not transferable to other units.

28.32**Certificates page**

How to get here: **Configuration** window > expand **System** > click **Certificates**

This page displays all available and used certificates. You can also create and upload new certificates and delete certificates that are no longer needed.

Usage list

Displays all applications and their certificates that are used in the system. Trusted certificates are displayed separately.

Usage column

Displays the application where certificates are needed.

Certificates/Trusted certificates column

From the list, select the certificate that belongs to the application in the **Usage** column.

Set

Click to save your actions.

File list

Displays all certificates that are available in the system.

Name column

Displays the file name of the certificate.

Type column

Displays the type of the certificate.

Key column

Displays that a key is available for the certificate.

Common name column

Displays the common name you must enter in case of generating a signing request to create a new certificate.

icon (Delete)

Click to delete the selected certificate.

icon (Download)

Click to download the certificate file.

Add

Click to upload existing certificates or to generate a signing request to obtain new certificates.

28.33 Maintenance page

Update server

The address of the firmware update server appears in the address box.

28.34 Decoder page

28.34.1 Decoder profile

Allows you to set the various options for the display of video images on an analog monitor or VGA monitor.

Monitor name

Type the name of the monitor. The monitor name facilitates the identification of the remote monitor location. Use a name that makes it as easy as possible to identify the location.

Click  to update the name in the Device Tree.

Standard

Select the video output signal of the monitor you are using. Eight pre-configured settings for the VGA monitors are available in addition to the PAL and NTSC options for analog video monitors.

Caution!

Selecting a VGA setting with values outside the technical specification of the monitor can result in severe damage to the monitor. Refer to the technical documentation of the monitor you are using.

Window layout

Select the default image layout for the monitor.

VGA screen size

Type the aspect ratio of the screen (for example 4 x 3) or the physical size of the screen in millimeters. The device uses this information to accurately scale the video image for distortion-free display.

28.34.2**Monitor display**

The device recognizes transmission interruptions and displays a warning on the monitor.

Display transmission disturbance

Select **On** to display a warning in case of transmission interruption.

Disturbance sensitivity

Move the slider to adjust the level of the interruption that triggers the warning.



Disturbance notification text

Type the text of the warning the monitor displays when connection is lost. The maximum text length is 31 characters.

Delete decoder logo

Click to delete the logo that has been configured on the Web page of the decoder.

29 ONVIF page

Main window >  **Devices** > Expand  > 







or

Main window >  **Devices** > Expand  > Expand  > Expand  > Expand  > 

See also

- *Video Streaming Gateway device page*, page 282
- *Live Only page*, page 286

29.1 ONVIF Encoder page

Main window >  **Devices** > Expand  > Expand  > Expand  > Expand  >  > **ONVIF Encoder** tab

or

Main window >  **Devices** > Expand  >  > **ONVIF Encoder** tab

Displays information on a live only ONVIF encoder added to your Bosch VMS.

Name

Displays the name of the ONVIF device. You can rename it in the Device Tree directly.

Network Address

Displays the IP address of the device.

Manufacturer

Displays the manufacturer name.

Model

Displays the model name.

Video Inputs

Enter the number of cameras connected to this encoder.

Audio Inputs

Enter the number of audio inputs connected to this encoder.

Alarm Inputs

Enter the number of alarm inputs connected to this encoder.

Relays







Enter the number of relays connected to this encoder.



See also

- *ONVIF Encoder Events page*, page 325
- *Adding a live only encoder*, page 169

- *Configuring ONVIF events, page 152*

29.2 ONVIF Encoder Events page

Main window >  **Devices** > Expand  > Expand  > Expand  > Expand
 >  > **ONVIF Encoder Events** tab
 or

Main window >  **Devices** > Expand  >  > **ONVIF Encoder Events** tab
 You can map ONVIF events to Bosch VMS events. This ensures that you later can configure ONVIF events as Bosch VMS alarms.

Mapping Table



You can create or edit a Mapping Table.



Click  to display the **Add Mapping Table** dialog box.

Click  to display the **Rename Mapping Table** dialog box.

Click  to remove the Mapping Table with all rows.

Click  or  to import or export an ONVIF Mapping Table.

Events and Alarms

Select a Bosch VMS event for mapping with an ONVIF event.

The following  events are available:

- **Onvif Generic Data 01**
- **Onvif Generic Data 02**
- **Onvif Generic Data 03**

The following  events are available:

- **Motion Detection - Motion Detected**
- **Motion Detection - Motion Stopped**
- **Reference Image Check - Deadjusted**
- **Reference Image Check - Adjusted**
- **Video Loss - Video Signal Lost**
- **Video Loss - Video Signal OK**
- **Video Loss - Video Signal State Unknown**
- **Video Signal Too Bright - Video Signal OK**
- **Video Signal Too Bright - Video Signal Not OK**
- **Video Signal Too Dark - Video Signal OK**
- **Video Signal Too Dark - Video Signal Not OK**
- **Video Signal Too Noisy - Video Signal OK Video Signal Not OK**
- **Relay State - Relay Opened**
- **Relay State - Relay Closed**

- **Relay State - Relay Error**
- **Input State - Input Opened**
- **Input State - Input Closed**
- **Input State - Input Error**

Add row

Click to add a row to the Mapping Table.

When multiple rows are available, an event occurs if one row is true.

Remove row

Click to remove the selected row from the Mapping Table.

ONVIF Topic

Type in or select a string, for example:

`tns1:VideoAnalytics/tnsaxis:MotionDetection`

ONVIF Data Name

Type in or select a string.

ONVIF Data Type

Type in or select a string.









ONVIF Data Value

Type in or select a string or number.

See also

- *ONVIF events, page 61*
- *Configuring ONVIF events, page 152*

29.2.1**Add / Rename ONVIF Mapping Table dialog box**

Main window >  **Devices** > Expand  > Expand  > Expand  > Expand
 >  > **ONVIF Encoder Events** tab >  or 
 or

Main window >  **Devices** > Expand  >  > **ONVIF Encoder Events** tab > 
 or 

Allows you to add a Mapping Table. If this Mapping Table shall serve as a template for future ONVIF encoders of the same manufacturer and model, select the correct entries.

Mapping Table name

Type in name for easy identification.







Manufacturer

Select an entry if required.

Model

Select an entry if required.

29.2.2 Import Mapping Table dialog box

Main window >  **Devices** > Expand  > Expand  > Expand  > Expand
 >  > **ONVIF Encoder Events** tab > 

or

Main window >  **Devices** > Expand  >  > **ONVIF Encoder Events** tab > 

You can import an ONVIF Mapping Table available as a file (OMF file).

Released ONVIF Mapping files are stored in the following directory of Configuration Client:

– %programdata%\Bosch\VMS\ONVIF

If the same Mapping Table name is already imported, an error message is displayed.

If a newer version of this file is imported, a warning is displayed. Click **OK** if you want to import this file. Otherwise click **Cancel**.

Manufacturer

Displays the manufacturer name this Mapping Table is valid for.

Model

Displays the model name this Mapping Table is valid for.

Description

Displays further information for example on tested camera models.

Mapping Table name

Displays the name of the Mapping Table. Change this name if it is already in use in Bosch VMS. You can select one of the following options to decide to which ONVIF encoders you want to apply the Mapping Table.

Apply only to selected ONVIF encoder

Apply to all ONVIF encoders of the listed models



Apply to all ONVIF encoders of the manufacturer

Existing ONVIF event mapping is continued. You cannot import OMT files from earlier Bosch VMS versions.



See also

– *Importing an ONVIF Mapping Table file, page 153*

29.3 ONVIF Configuration page

Main window >  **Devices** > Expand  > Expand  > Expand  > Expand
 >  > **ONVIF Configuration** tab

or

Main window >  **Devices** > Expand  >  > **ONVIF Configuration** tab
 You can select multiple ONVIF encoders and change settings on the **Video Encoder Profile** page. The changed settings are valid for all selected devices.

This page is only available for ONVIF encoders.



Notice!

Limitations of ONVIF configuration

Settings which you perform on these pages, are possibly not executed correctly because they are not supported by your camera. Supported ONVIF cameras were tested only with default settings.

29.3.1

Unit Access

Main window >  **Devices** > Expand  > Expand  > Expand  > Expand
 >  > **ONVIF Configuration** tab > **Main Settings** tab > **Unit Access** tab
 or

Main window >  **Devices** > Expand  >  > **ONVIF Configuration** tab > **Main Settings** tab > **Unit Access** tab

Manufacturer

Displays the manufacturer name of the selected encoder.

Model

Displays the model name of the selected encoder.

Note: If you want to export any event mappings into a ONVIF Mapping file select this model name as file name.

Hardware ID

Displays the hardware ID of the selected encoder.

Firmware version

Displays the firmware version of the selected encoder.

Note: Please ensure with the Bosch VMS compatibility list whether the firmware version is correct.

Serial number

Displays the serial number of the selected encoder.

MAC address

Displays the MAC address of the selected encoder.



ONVIF version

Displays the ONVIF version of the selected encoder.

For Bosch VMS, the ONVIF version 2.0 is required.

29.3.2

Date / Time

Main window >  **Devices** > Expand  > Expand  > Expand  > Expand
 >  > **ONVIF Configuration** tab > **Main Settings** tab > **Date/Time** tab
 or

 Main window >  **Devices** > Expand  >  > **ONVIF Configuration** tab > **Main Settings** tab > **Date/Time** tab

Time zone

Select the time zone in which the system is located.

If there are multiple devices operating in your system or network, it is important to synchronize their internal clocks. For example, it is only possible to identify and correctly evaluate simultaneous recordings when all devices are operating on the same time.







1. Enter the current date. Since the device time is controlled by the internal clock, it is not necessary to enter the day of the week – it is added automatically.
2. Enter the current time or click **Sync to PC** to apply the system time from your computer to the device.

Note:

It is important that the date/time is correct for recording. An incorrect date/time setting could prevent correct recording.

29.3.3

User Management

 Main window >  **Devices** > Expand  > Expand  > Expand  > Expand  >  > **ONVIF Configuration** tab > **Main Settings** tab > **User Management** tab
 or

 Main window >  **Devices** > Expand  >  > **ONVIF Configuration** tab > **Main Settings** tab > **User Management** tab

These user settings are used for 3rd party applications such as direct Web Client access to encoders.

Following user roles for the access of 3rd party applications are supported:

- **Anonymous:** This role has unlimited access only to those devices where no users from other roles (**User, Operator, Administrator**) are registered. On the devices with at least one above mentioned user, the anonymous user has the right only to view time settings.
- **Administrator** (not supported by Configuration Client): This role has access to all application sections and features, the rights to reboot the device, reset settings and update firmware as well as create other users with different access rights.

The first user created on the device must be **Administrator**.

For differences in Operator's and User's default access rights of the **Operator** role and the **User** role, see the following table.

ONVIF Configuration Section or Feature	Operator	User
Identification	VIEW	HIDDEN
Time Settings	VIEW	VIEW
Network Settings	VIEW	VIEW

Users	HIDDEN	HIDDEN
Relays Settings	CHANGE	VIEW
Live Video (including rtsp-link)	CHANGE	CHANGE
Video Streaming	CHANGE	VIEW
Profiles	CHANGE	VIEW

CHANGE - Change current and create new settings.

VIEW - Settings are not hidden, but it is not permitted to change and create them.

HIDDEN - Certain settings or even the whole sections are hidden.

Users

Lists the available users of the device.

Password

Type in a valid password.

Confirm password







Confirm the typed in password.



Role

Select the desired role for the selected user. Access rights are adapted accordingly.

29.3.4

Video Encoder Profile page

Main window >  **Devices** > Expand >  > Expand >  > Expand >  > Expand
 >  > **ONVIF Configuration** tab > **Camera** tab > **Video Encoder Profile** tab
 or

Main window >  **Devices** > Expand >  >  > **ONVIF Configuration** tab > **Camera** tab > **Video Encoder Profile** tab

Profiles are rather complex and include a number of parameters that interact with one another, so it is generally best to use the pre-defined profiles. Only change a profile if completely familiar with all the configuration options.



Profiles

Click the desired name.

Notice!

The profiles configured here can be selected in Configuration Client.



In the main window, click  **Cameras and Recording** and click  or  .
 The default setting ' <Automatic> ' can be changed to one of the listed and configured profiles
Note: Take care when using actively more than 1 profile of a single device that certain performance restrictions apply and possibly the camera automatically restricts the quality of a stream in overload situations.

Name

You can enter a new name for the profile here. The name is then displayed in the list of available profiles in the Active profile field.

Encoding

Select the desired codec.

- H.264 MP: This setting represents the H.264 Main Profile and offers the maximum configuration options for the H.264 code algorithm. This setting also enables the best image quality and the lowest band width.
- H.264 BP+: This profile setting represents the H.264 Baseline Profile plus, a function from the Main Profile toolset that supports interlace video.

Resolution

Select the desired resolution for the video image.

Quality

This parameter allows you to reduce the load on the channel by means of reducing the picture definition. The parameter is set with the help of the slider bar: The left most position corresponds to the highest picture definition, the right most - to the lowest load on the video channel.

Frame rate limit

Frame rate (frame per second) denotes how many frames per second are captured by the video camera connected to the device. This parameter is shown just for information. If an encoding interval is provided the resulting encoded frame rate is reduced by the given factor.

Bit rate limit

The less the bit rate is, the less the final video file size. But when the bit rate is considerably reduced, the program will have to use stronger compression algorithms, which also reduces video quality.

Select the maximum output bit rate in kbps. This maximum data rate is not exceeded under any circumstances. Depending on the video quality settings for the I- and P-frames, this fact can result in individual images being skipped.

The value entered here should be at least 10% greater than the typical target data bit rate.

Encoding interval

Encoding interval (number of frames) denotes at which rate the frames coming from the camera are encoded. For example, when encoding the interval comprises 25, it means that 1 frame from 25 captured per second is encoded and transmitted to the user. The maximum value reduces the load on the channel but may cause skipping information from the frames that were not encoded. Reducing the encoding interval increases the frequency of picture update as well as the load on the channel.

GOP length

GOP length is possible to edit only in case the encoder is H.264. This parameter denotes the length of the picture group between the two key frames. The higher this value is, the less the load to the network is, but the video quality is affected.

An entry of 1 indicates that I-frames are continuously generated. An entry of 2 indicates that every second image is an I-frame, and 3 only every third frame, and so on. The frames in between are encoded as P-frames or B-frames.

Session timeout

The RTSP session timeout for the related video stream.

The session timeout is provided as a hint for keeping RTSP session by a device.

Multicast - IP address

Enter a valid multicast address to be operated in multicast mode (duplication of the data stream in the network).

With a 0.0.0.0 setting, the encoder for the stream operates in multi-unicast mode (copying of data stream in device). The camera supports multi-unicast connections for up to five simultaneously connected receivers.

Duplication of data places a heavy demand on the CPU and can lead to impairment of the image quality under certain circumstances.

Multicast - Port

Select the RTP multicast destination port. A device may support RTCP. In this case the port value shall be even to allow the corresponding RTCP stream to be mapped to the next higher (odd) destination port number as defined in the RTSP specification.

Multicast - TTL







A value can be entered to specify how long the multicast data packets are active on the network. If multicast is to be run via a router, the value must be greater than 1.

**Notice!**



Multicast operation is only possible with the UDP protocol. The TCP protocol does not support multicast connections.

If the device is operated behind a Firewall, select TCP (HTTP port) as the transfer protocol. For use in a local network, select UDP.

29.3.5**Audio Encoder Profile**

Main window >  **Devices** > Expand  > Expand  > Expand  > Expand  >  > **ONVIF Configuration** tab > **Camera** tab > **Audio Encoder Profile** tab

or

Main window >  **Devices** > Expand  >  > **ONVIF Configuration** tab > **Camera** tab > **Audio Encoder Profile** tab

Profiles are rather complex and include a number of parameters that interact with one another, so it is generally best to use the pre-defined profiles. Only change a profile if completely familiar with all the configuration options.

Encoding

Select the desired encoding for the audio source if available:

- **G.711 [ITU-T G.711]**
- **G.726 [ITU-T G.726]**
- **AAC [ISO 14493-3]**

Note: AAC is not supported by Bosch VMS. Please select another codec.

Bit rate

Select the desired bit rate, for example 64 kbps, for transmitting the audio signal.

Sample rate







Enter the output sample rate in kHz, for example 8 kbps.



Session timeout

The RTSP session timeout for the related audio stream.

The session timeout is provided as a hint for keeping RTSP session by a device.

29.3.6**Imaging General**

Main window >  **Devices** > Expand  > Expand  > Expand  > Expand
 >  > **ONVIF Configuration** tab > **Camera** tab > **Imaging General** tab
 or

Main window >  **Devices** > Expand  >  > **ONVIF Configuration** tab >
Camera tab > **Imaging General** tab

Brightness

Adjust the image brightness to your working environment.

Color saturation

Adjust the color saturation in the image to make the reproduction of colors on your monitor as realistic as possible.

Contrast

You can adapt the contrast of the video image to your working environment.

Sharpness

Adjust the sharpness in the image.







A low value makes the picture less sharp. Increasing sharpness brings out more detail. Extra sharpness can enhance the details of license plates, facial features and the edges of certain surfaces but can increase bandwidth requirements.

IR cut-off filter

Select the state of the IR cut-off filter.

The AUTO state lets the exposure algorithm handle when the IR cut-off filter is switched.

29.3.7**Backlight Compensation**

Main window >  **Devices** > Expand  > Expand  > Expand  > Expand
 >  > **ONVIF Configuration** tab > **Main Settings** tab > **Backlight compensation** tab
 or

Main window >  **Devices** > Expand  >  > **ONVIF Configuration** tab > **Main Settings** tab > **Backlight compensation** tab
 Depending on the device model you can configure here parameters for the backlight compensation.

Mode







Select **Off** to switch off backlight compensation.

Select **On** to capture details in high-contrast and extremely bright-dark conditions.

Level

Enter or select the desired value.

29.3.8**Exposure**

Main window >  **Devices** > Expand  > Expand  > Expand  > Expand  >  > **ONVIF Configuration** tab > **Main Settings** tab > **Exposure** tab

or

Main window >  **Devices** > Expand  >  >  > **ONVIF Configuration** tab > **Main Settings** tab > **Exposure** tab

Depending on the device model you can configure here parameters for the exposure.

Mode

Select **Auto** to enable the exposure algorithm on the device. The values in the following fields are used by the algorithm:

- **Priority**
- **Window**
- **Min. exposure time**
- **Max. exposure time**
- **Min. gain**
- **Max. gain**
- **Min. iris**

Select **Manual** to disable the exposure algorithm on the device. The values in the following fields are used by the algorithm:

- **Exposure time**
- **Gain**
- **Iris**

Priority

Configure the exposure priority mode (low noise/frame rate).

Window

Define a rectangular exposure mask.

Min. exposure time

Configure the minimum exposure time period [μ s].

Max. exposure time

Configure the maximum exposure time period [μ s].

Min. gain

Configure the minimum sensor gain range [dB].

Max. gain

Configure the maximum sensor gain range [dB].

Min. iris

Configure the minimum attenuation of input light affected by the iris [dB]. 0dB maps to a fully opened iris.

Max. iris

Configure the maximum attenuation of input light affected by the iris [dB]. 0dB maps to a fully opened iris.

Exposure time

Configure the fixed exposure time [μ s].

Gain







Configure the fixed gain [dB].

Iris

Configure the fixed attenuation of input light affected by the iris [dB]. 0dB maps to a fully opened iris.

29.3.9

Focus

 Main window >  **Devices** > Expand  > Expand  > Expand  > Expand
 >  > **ONVIF Configuration** tab > **Main Settings** tab > **Focus** tab

or

 Main window >  **Devices** > Expand  >  > **ONVIF Configuration** tab > **Main Settings** tab > **Focus** tab

Depending on the device model you can configure here parameters for the focus. This page allows for moving the lens in an absolute, a relative or in a continuous way. Focus adjustments through this operation turn off the autofocus. A device with support for remote focus control usually supports control through this move operation. The focus position is represented with a certain numeric value. The state of the focus can be one of the following:

MOVING

OK

UNKNOWN

Additionally error information can be displayed, for example a positioning error indicated by the hardware.

Mode

Select **Auto** to enable the lens to automatically focus at any time according to the objects in the scene. The values in the following fields are used by the algorithm:

- **Near limit**
- **Far limit**

Select **Manual** to adjust the focus manually. The values in the following fields are used by the algorithm:

- **Default speed**

Default speed

Configure the default speed for focus move operation (when the speed parameter not is present).





Far limit



Configure the near limit for focus lens [m].

Far limit

Configure the far limit for focus lens [m].

29.3.10 Wide Dynamic Range

Main window >  **Devices** > Expand  > Expand  > Expand  > Expand  >  > **ONVIF Configuration** tab > **Main Settings** tab > **Wide Dynamic Range** tab
or

Main window >  **Devices** > Expand  >  > **ONVIF Configuration** tab > **Main Settings** tab > **Wide Dynamic Range** tab
Depending on the device model you can configure here parameters for the wide dynamic range.





Mode

Enter or select the desired value.

Level

Enter or select the desired value.

29.3.11 White balance

Main window >  **Devices** > Expand  > Expand  > Expand  > Expand  >  > **ONVIF Configuration** tab > **Main Settings** tab > **White Balance** tab
or

Main window >  **Devices** > Expand  >  > **ONVIF Configuration** tab > **Main Settings** tab > **White Balance** tab
Depending on the device model you can configure here parameters for the white balance.

Mode

Auto mode allows the camera to continually adjust for optimal color reproduction using an average reflectance method or in an environment with natural light sources.

In Manual mode the Red, Green, and Blue gain can be manually set to a desired position

It is only necessary to change the white point offset for special scene conditions:

- indoor light sources and for colored LED light illumination
- sodium vapor light sources (street lighting)
- for any dominant color in the image for example, the green of a football pitch or of a gaming table

R-gain

In Manual white balance mode, adjust the Red gain slider to offset the factory white point alignment (reducing Red, increases Cyan).



B-gain

In Manual white balance mode, adjust the Blue gain slider to offset the factory white point alignment (reducing Blue, increases Yellow).

29.3.12

Network Access

Main window >  **Devices** > Expand  > Expand  > Expand  > Expand

 >  > **ONVIF Configuration** tab > **Network** tab > **Network Access** tab

or

Main window >  **Devices** > Expand  >  > **ONVIF Configuration** tab > **Network** tab > **Network Access** tab

Here you can configure various network settings.

Ethernet IPv4

DHCP

If a DHCP server is employed in the network for the dynamic assignment of IP addresses, you can activate acceptance of IP addresses automatically assigned to the encoder.

Bosch VMS uses the IP address for the unique assignment of the encoder. The DHCP server must support the fixed assignment between IP address and MAC address, and must be appropriately set up so that, once an IP address is assigned, it is retained each time the computer is restarted.

Subnet mask

Type in the appropriate subnet mask for the set IP address.

If DHCP server is enabled, the subnet mask is automatically assigned.

Default gateway

If you want the module to establish a connection to a remote location in a different subnet, type in the IP address of the gateway here. Otherwise leave the field empty (0.0.0.0).

Ethernet IPv6

DHCP

Enter or select the desired value.

IP address

Displays the IPv6 address of the device, provided by the DHCP server.

Prefix length

Displays the prefix length of the device, provided by the DHCP server.

Default gateway

Displays the default gateway of the device, provided by the DHCP server.

Host name

Enter or select the desired value.

DNS

Using a DNS server, the device can resolve an address indicated as a name. Enter the IP address of the DNS server here.

NTP servers

Type in the IP address of the desired time server or let the DHCP server do this for you.

The encoder can receive the time signal from a time server using various time server protocols, and then use it to set the internal clock. The module polls the time signal automatically once every minute. Enter the IP address of a time server here. This supports a high level of accuracy and is required for special applications.

HTTP ports

Select a different HTTP browser port if required. The default HTTP port is 80. If you want to allow only secure connections via HTTPS, you must deactivate the HTTP port.

Note: Not supported by Bosch VMS.

HTTPS ports

Note: Not supported by Bosch VMS.

If you want to grant access on the network via a secure connection, select an HTTPS port if necessary. The default HTTPS port is 443. Select the **Off** option to deactivate HTTPS ports; only unsecured connections will now be possible.

Default gateway

Enter or select the desired value.

RTSP ports

If necessary, select a different port for the exchange of the RTSP data. The standard RTSP port is 554. Select **Off** to deactivate the RTSP function.

Zero configuration address

Enable or disable the zero configuration discovery of the selected camera.

Zero configuration is an alternative method to DHCP and DNS for assigning IP addresses to cameras. It automatically creates a usable IP network address without configuration or special servers.

Note: In the ONVIF standard only the service discovery of zero configuration is used. Alternatively without zero configuration the network must provide services, such as DHCP or DNS.

Otherwise configure the network settings of each IP camera manually.

ONVIF discovery mode

If enabled, the camera can be scanned in the network. This includes its capabilities.

If disabled, the camera does not send any discovery messages to avoid denial-of-service attacks.

We recommend disabling the discovery after adding the camera to the configuration.

Enter or select the desired value.

Enable DynDNS

Allows for enabling DynDNS.

A dynamic Domain Name Service (DNS) allows you to select the unit via the Internet using a host name, without having to know the current IP address of the unit. To do this, you must have an account with one of the dynamic DNS providers and you must register the required host name for the unit on that site.

Note:

For information about the service, registration process and available host names refer to the DynDNS provider on dyndns.org.

Type

Enter or select the desired value.

Name

Type in the name of your DynDNS user account.

TTL

Enter or select the desired value.

29.3.13 Scopes

Main window >  **Devices** > Expand  > Expand  > Expand  > Expand

 >  > **ONVIF Configuration** tab > **Network** tab > **Scopes** tab

or

Main window >  **Devices** > Expand  >  > **ONVIF Configuration** tab > **Network** tab > **Scopes** tab

You can add or remove scopes to your ONVIF device with URIs having the following format:

```
onvif://www.onvif.org/<path>
```

The following example illustrates the usage of the scope value. This is just an example, and not at all an indication of what type of scope parameter to be part of an encoder configuration. In this example we assume that the encoder is configured with the following scopes:

```
onvif://www.onvif.org/location/country/china
onvif://www.onvif.org/location/city/beijing
onvif://www.onvif.org/location/building/headquarter
onvif://www.onvif.org/location/floor/R5
onvif://www.onvif.org/name/ARV-453
```

You can give the device a detailed location and device name to identify it within your list of devices.







The table shows the basic capabilities and other properties of the device, which are standardized:

Category	Defined values	Description
type	video_encoder	The device is a network video encoder device.
	Ptz	The device is a PTZ device.
	audio_encoder	The device provides audio encoder support.
	video_analytics	The device supports video analytics.
	Network_Video_Transmitter	The device is a network video transmitter.
	Network_Video_Decoder	The device is a network video decoder.
	Network_Video_Storage	The device is a network video storage device.
Network_Video_Analytic	The device is a network video analytics device.	
location	Any character string or path value.	Not supported by Bosch VMS.
hardware	Any character string or path value.	A string or path value describing the hardware of the device. A device shall include at least one hardware entry into its scope list.
name	Any character string or path value.	The searchable name of the device. This name is displayed in the Device and the Logical Tree.

The scope name, model, manufacturer determine how the device appears in the Device Tree and the ONVIF Encoder Identification and Main Settings.

29.3.14

Relays

Main window >  **Devices** > Expand  > Expand  > Expand  > Expand  >  > **ONVIF Configuration** tab > **Interfaces** tab > **Relay** tab

Main window >  **Devices** > Expand  >  > **ONVIF Configuration** tab > **Interfaces** tab > **Relay** tab

The physical idle state of a relay output can be configured by setting the idle state to **open** or **closed** (inversion of the relay behavior).

The available digital outputs of the device are listed with their name, e.g.:

- **AlarmOut_0**
- **AlarmOut_1**

For any event mapping of relays within Bosch VMS use the names listed here.

Mode

The relay can work in two relay modes:

- **Bistable:** After setting the state, the relay remains in this state.
- **Monostable:** After setting the state, the relay returns to its idle state after the specified delay time.

Idle state

Select **Open** if you want the relay to operate as a normally open contact, or select **Closed** if the relay is to operate as a normally closed contact.

Delay time

Set the delay time. After this time period, the relay switches back to its idle state if configured in the **Monostable** mode.

If you like to test any configurations related to a relay status change, click **Activate** or **Deactivate** to switch the relay. You can check the configured camera relay events for correct functioning: Status display of the relay icon in Logical Tree, Events in Alarm List or Event Log.

Activate

Click to switch the relay to the configured idle state.

Deactivate

Click to switch the relay to the configured non-idle state.

29.4







ONVIF Event Source page

Main window >  **Devices** > Expand  > Expand  > Expand  > Expand  > Expand  >  > **ONVIF Event Source** tab





or

Main window >  **Devices** > Expand  > Expand  >  > **ONVIF Event Source** tab





or

Main window >  **Devices** > Expand  > Expand  > Expand  > Expand  > Expand  >  > **ONVIF Event Source** tab

or

Main window >  **Devices** > Expand  > Expand  >  > **ONVIF Event Source** tab

or

Main window >  **Devices** > Expand  > Expand  > Expand  > Expand  > Expand  >  > **ONVIF Event Source** tab

or

Main window >  **Devices** > Expand  > Expand  >  > **ONVIF Event Source** tab

You can configure ONVIF events of a source (video channel, input or relay). An activated event definition is added to the Mapping Table of the encoder.

For example for a multichannel encoder, you configure for which camera a **Motion Detected** event is triggered.

Trigger Event

Activate this event.

ONVIF Topic

Type in or select a string.

ONVIF Source Name

Type in or select a string.

ONVIF Source Type

Type in or select a string.

ONVIF Source Value

Type in or select a string.

See also

- *ONVIF events, page 61*
- *Configuring ONVIF events, page 152*

30 Maps and Structure page

The count of items below an entry is displayed in square brackets.



Main window > **Maps and Structure**

Permissions can get lost. If you move a group of devices, these devices lose their permission settings. You must set the permissions on the **User Groups** page again.

Displays the Device Tree, the Logical Tree, and the map window.

Allows you to introduce a structure for all the devices in your Bosch VMS. Your structure is displayed in the Logical Tree.

Allows you to perform the following tasks:

- Configuring the Full Logical Tree
- Managing resource files, assigning them to nodes
- Creating hot spots on a map
- Creating a malfunction relay

Resource files can be:

- Site map files
- Document files
- Web files
- Audio files
- Command Scripts
- Camera sequence files

Hot spots can be:

- Cameras
- Inputs
- Relays
- Command Scripts
- Sequences
- Links to other maps



Displays a dialog box for managing resource files.



Displays a dialog box for adding or managing Command Scripts to the Logical Tree.



Displays a dialog box for adding or editing a camera sequence file.



Creates a folder in the Logical Tree.



Displays a dialog box for adding map resource files.



Displays a dialog box for adding a document file (HTML, HTM, TXT, URL, MHT).



Displays a dialog box for adding a link to an external application.



Displays a dialog box for adding a malfunction relay.



: Device was added to the Logical Tree.



Type in a string and press the ENTER key to filter the displayed items. Only items containing the string and their corresponding parent items (only in trees) are displayed. The count of filtered items and the total count of items is provided. An active filter is indicated by . Enclose strings with double quotes to find them exactly, for example "Camera 1" exactly filters the cameras with this name, not camera 201.

To cancel filtering, click .

30.1 Resource Manager dialog box



Main window > **Maps and Structure** > > **Resource Manager** dialog box

Allows you to manage resource files.

You can manage the following file formats:

- DWF files (map resource files)
For use in Operator Client, these files are converted to a bitmap format.
- HTML files (HTML documents, e.g. action plans)
- MP3 (audio file)
- TXT files (text files)
- URL files (contain links to Web pages)
- MHT files (Web archives)
- WAV (audio file)
- EXE



Click to display a dialog box for importing a resource file.



Click to display the **Add URL** dialog box.



Click to display the **Link to External Application** dialog box.



Click to remove the selected resource file.



Click to rename the selected resource file.



Click to display a dialog box for replacing the selected resource file with another one.



Click to display a dialog box for exporting the selected resource file.

See also

- *Managing resource files, page 176*

30.2 Select Resource dialog box



Main window > **Maps and Structure** >

Allows you to add a map file in DWF format to the Logical Tree.

Select a resource file:

Click a filename to select a map file. The content of the selected file is displayed in the preview pane.

Manage...

Click to display the **Resource Manager** dialog box.

See also

- *Adding a map, page 179*
- *Assigning a map to a folder, page 180*
- *Adding a document, page 181*

30.3**Sequence Builder dialog box**

Main window > **Maps and Structure** >

Allows you to manage camera sequences.



Click to display the **Add Sequence** dialog box.



Click to rename a camera sequence.



Click to remove the selected camera sequence.

**Notice!**

When you delete a sequence in the **Sequence Builder** dialog box, this sequence is automatically removed from the **Initial sequence** list of a monitor wall if configured there.

Add Step

Click to display the **Add Sequence Step** dialog box.

Remove Step

Click to remove selected steps.

Step

Displays the number of the step. All cameras of a particular step have the same dwell time.

Dwell

Allows you to change the dwell time (seconds).

Camera Number

Click a cell to select a camera via its logical number.

Camera

Click a cell to select a camera via its name.

Camera Function

Click a cell to change the function of the camera in this row.

Data

Type the time for the duration of the selected camera function. To configure this, you must have selected an entry in the **Camera** column and an entry in the **Camera Function** column.

Data Unit

Select the unit for the selected time, for example seconds. To configure this, you must have selected an entry in the **Camera** column and an entry in the **Camera Function** column.

Add to Logical Tree

Click to add the selected camera sequence to the Logical Tree and to close the dialog box.

See also

- *Monitor Wall page, page 252*
- *Managing pre-configured camera sequences, page 177*

30.4 Add Sequence dialog box

Main window >  **Maps and Structure** >  > **Sequence Builder** dialog box > 

Allows you to configure the properties of a camera sequence.

Sequence name:

Type an appropriate name for the new camera sequence.

Logical number:

For using with a Bosch IntuiKey keyboard, enter a logical number for the sequence.

Dwell time:

Enter the appropriate dwell time.

Cameras per step:

Enter the number of cameras in each step.

Steps:

Enter the appropriate number of steps.

See also

- *Managing pre-configured camera sequences, page 177*

30.5 Add Sequence Step dialog box

Main window >  **Maps and Structure** >  > **Add Step** button

Allows you to add a step with a new dwell time to an existing camera sequence.



Dwell time:

Enter the appropriate dwell time.

See also

- *Managing pre-configured camera sequences, page 177*

30.6 Add URL dialog box

Main window >  **Maps and Structure** >  > 

Allows you to add an Internet address (URL) to your system. You can add this Internet address to the Logical Tree as a document. The user can display an Internet page in his Operator Client.

Name:

Type a display name for the URL.

URL:

Type the URL.

See also

- *Adding a document, page 181*

30.7 Select Map for Link dialog box



Main window > **Maps and Structure** > Select a map folder  in the Logical Tree > On the map, right-click and click **Create Link**

Allows you to select a map for creating a link to another map.



Click another map to select.

Select

Click to insert the link to the selected map.

See also

- *Adding a link to another map, page 180*

30.8 Malfunction Relay dialog box



Main window > **Maps and Structure** >  > **Malfunction Relay** dialog box

You can add a malfunction relay to your system. You define the relay that is to be used as malfunction relay and you configure the events that can trigger the malfunction relay.

The relay must already be configured in the Logical Tree.

Malfunction Relay

In the list, select the desired relay.

Events...

Click to display the **Events selection for Malfunction Relay** dialog box.

See also

- *Adding a malfunction relay, page 182*
- *Malfunction relay, page 56*

30.9 Link to External Application dialog box



Main window > **Maps and Structure** >  > **Resource Manager** dialog box >  > **Link to External Application** dialog box

Allows you to add a link to an external application. The link must be valid on the workstation where this link is used.

Caution!

An external application that starts with a splash screen will not work as expected.
An external application which shares functions with Operator Client, will not work as expected and can, under rare circumstances, lead to a crash of Operator Client.

Name

Type in a name for the link that is displayed in the Logical Tree.

Path

Type in or browse the path to the external application. This path must be valid on the workstation where the user of Operator Client uses this link.

Arguments

If required, type in arguments for the command that executes the external application.

31 Schedules page



Main window >

Allows you to configure Recording Schedules and Task Schedules.



Click to rename the selected Recording or Task Schedule.

Recording Schedules

Displays the Recording Schedules Tree. Select an entry for configuring.

Task Schedules

Displays the Task Schedules Tree. Select an entry for configuring.

Add

Click to add a new Task Schedule.

Delete

Click to delete the selected Task Schedule.

See also

- *Configuring schedules, page 183*

31.1 Recording Schedules page



Main window >  > Select an item in the Recording Schedules tree

Allows you to configure Recording Schedules.

Weekdays

Click to display the Schedule Table for weekdays. The time periods of all configured Recording Schedules are displayed.

Drag the pointer to select the time periods for the selected schedule. All selected cells get the color of the selected schedule.

The 24 hours of the day are displayed horizontally. Every hour is divided into 4 cells. One cell represents 15 minutes.

Holidays

Click to display the Schedule Table for holidays.

Exception Days

Click to display the Schedule Table for exception days.

Add

Click to display a dialog box for adding the required holidays or exception days.

Delete

Click to display a dialog box for removing holidays or exception days.

See also

- *Configuring a Recording Schedule, page 183*
- *Adding holidays and exception days, page 185*
- *Removing holidays and exception days, page 186*
- *Renaming a schedule, page 186*

31.2 Task Schedules page



Main window > > Select an item in the Task Schedules tree

Allows you to configure the available Task Schedules. You can configure a standard or a recurring pattern.

Standard

Click to display the Schedule Table for configuring standard Task Schedules. If you configure a Standard Pattern, no Recurring Pattern is valid for the selected schedule.

Recurring

Click to display the Schedule Table for configuring a recurring pattern for the selected Task Schedule. For example, you configure a schedule for every second Tuesday of every month or for the 4th of July of every year. If you configure a recurring pattern, no standard pattern is valid for the selected Task Schedule.

Weekdays

Click to display the Schedule Table for weekdays.

Drag the pointer to select the time periods for the selected schedule. The selected cells are displayed in the color of the selected schedule.

The 24 hours of the day are displayed horizontally. Every hour is divided into 4 cells. One cell represents 15 minutes.

Holidays

Click to display the Schedule Table for holidays.

Exception Days

Click to display the Schedule Table for exception days.

Clear All

Click to clear the time periods of all available days (weekdays, holidays, exception days).

Select All

Click to select the time periods of all available days (weekdays, holidays, exception days).

Add...

Click to display a dialog box for adding the required holidays or exception days.

Delete...

Click to display a dialog box for deleting holidays or exception days.

Recurrence Pattern

Click the frequency with which you want the Task Schedule to recur (Daily, Weekly, Monthly, Yearly) and then select the corresponding options.

Day Pattern

Drag the pointer to select the time period(s) for the recurring pattern.

See also

- *Adding a Task Schedule, page 184*
- *Configuring a standard Task Schedule, page 184*
- *Configuring a recurring Task Schedule, page 184*
- *Removing a Task Schedule, page 185*
- *Adding holidays and exception days, page 185*
- *Removing holidays and exception days, page 186*
- *Renaming a schedule, page 186*

32 Cameras and Recording page



Main window > **Cameras and Recording**

Displays the Camera Table page or a Recording Table page.

Allows you to configure camera properties and recording settings.

Allows you to filter the cameras that are displayed according to their type.



Click to copy recording settings from one Recording Schedule to another.



Click to display the **Stream Quality Settings** dialog box.



Click to display the **Scheduled Recording Settings** dialog box.



Click to display the dialog box for configuring a selected PTZ camera.



Displays all available cameras regardless of their storage device.



Click to change the Camera Table according to the selected storage device.



Displays the corresponding Camera Table. No recording settings are available because these cameras are not recorded in Bosch VMS.



Type in a string and press the ENTER key to filter the displayed items. Only items containing the string and their corresponding parent items (only in trees) are displayed. The count of filtered items and the total count of items is provided. An

active filter is indicated by . Enclose strings with double quotes to find them exactly, for example "Camera 1" exactly filters the cameras with this name, not camera 201.

To cancel filtering, click .

32.1 Cameras page



Main window > **Cameras and Recording** > Click an icon to change the Cameras page



according to the desired storage device, for example

Displays various information on the cameras available in your Bosch VMS.

Allows you to change the following camera properties:

- Camera name
- Assignment of an audio source
- Logical number
- PTZ control, if available
- Live quality (VRM and Live / Local Storage)
- Recording settings profile
- Minimum and maximum storage time
- Region of Interest (ROI)
- Automated Network Replenishment
- Dual Recording

- ▶ Click a column title to sort the table by this column.

Camera - Encoder

Displays the device type.

Camera - Camera

Displays the name of the camera.

Camera - Network Address

Displays the IP address of the camera.

Camera - Location

Displays the location of the camera. If the camera is not assigned to a Logical Tree yet, **Unassigned Location** is displayed.

Camera - Platform

Displays the platform name of this encoder.

Camera - Device Family

Displays the name of the device family to which the selected camera belongs.

Camera - Number

Click a cell to edit the logical number that the camera received automatically when it was detected. If you enter an already used number, a corresponding error message is displayed. The logical number is "free" again when the camera is removed.

Audio

Click a cell to assign an audio source to the camera.

If an alarm occurs with low priority and with a camera that has audio configured, this audio signal is played even when an alarm with higher priority is currently being displayed. But this is only true, if the high priority alarm has no audio configured.

Stream 1 - Codec / Stream 2 - Codec (only VRM and Local Storage)

Click a cell to select the desired codec for encoding the stream.

Stream 1 - Quality / Stream 2 - Quality

Select the desired quality of the stream used for live or recording. You configure quality settings in the **Stream Quality Settings** dialog box.

Live Video - Stream (only VRM and Live Only and Local Storage)

Click a cell to select the stream for a VRM or a local storage / live only encoder.

Live Video - Profile (only available for ONVIF cameras)

Click a cell to browse for the available live profile tokens of this ONVIF camera.

If you select the **<Automatic>** entry, the stream with the highest quality is automatically used.

Live Video - ROI

Click to enable Region of Interest (ROI). This is only possible if in the **Quality** column the H.264 MP SD ROI item is selected for stream 2 and stream 2 is assigned to Live Video.

Note: If stream 1 is used for Live for a specific workstation then the Operator Client running on this workstation cannot enable ROI for this camera.



is automatically enabled in the  table.

Recording - Setting

Click a cell to select the required recording setting. You configure the available recording settings in the **Scheduled Recording Settings** dialog box.

Recording - Profile (only available for ONVIF cameras)

Click a cell to browse for the available recording profile tokens of this ONVIF camera. Select the desired entry.

Recording - ANR

Select a check box to enable the ANR function. You can only enable this function, if the encoder has an appropriate firmware version and an appropriate device type.

Recording - Max Pre-Alarm Duration

Displays the calculated maximum pre-alarm duration for this camera. This value can help you in calculating the required storage capacity of the local storage medium.

**Notice!**

If a Mirrored VRM is already configured for an encoder, you cannot change any settings for this encoder in the **Secondary Recording** columns.

Secondary Recording - Setting (only available if a Secondary VRM is configured)

Click a cell to assign a scheduled recording setting to the dual recording of this encoder. Depending on your configuration it can happen that the configured stream quality for secondary recording is not valid. The stream quality configured for primary recording is then used instead.

Secondary Recording - Profile (only available for ONVIF cameras)

Click a cell to browse for available recording profile tokens of this ONVIF camera.



(Only visible when you click  **All**)

Select a check box to activate PTZ control.

Note:

For port settings refer to *COM1*, page 311.

Port (Only visible when you click  **All**)

Click a cell to specify which encoder serial port is used for PTZ control. For a PTZ camera connected to a Bosch Allegiant system, you can select **Allegiant**. For such a camera you do not need to use a trunk line.

Protocol (Only visible when you click  **All**)

Click a cell to select the appropriate protocol for the PTZ control.

PTZ Address (Only visible when you click  **All**)

Type the address number for the PTZ control.

Recording - Storage Min Time [days]**Secondary Recording - Storage Min Time [days] (only VRM and Local Storage)**

Click a cell to edit the minimum number of days that video data from this camera is retained. Recordings younger than this number of days are not deleted automatically.

Recording - Storage Max Time [days]**Secondary Recording - Storage Max Time [days] (only VRM and Local Storage)**

Click a cell to edit the maximum number of days that video data from this camera is retained. Only recordings older than this number of days are deleted automatically. 0 = unlimited.

See also

- *Configuring dual recording in the Camera Table*, page 194
- *Configuring PTZ camera settings*, page 193
- *Configuring PTZ port settings*, page 192
- *Configuring stream quality settings*, page 189

- Copying and pasting in tables, page 188
- Configuring the ANR function, page 194
- Exporting the Camera Table, page 189
- Assigning an ONVIF profile, page 151
- Configuring the ROI function, page 193

32.2 Scheduled Recording Settings dialog box (only VRM and Local Storage)



Main window > **Cameras and Recording** >

Allows you to configure schedule-dependent recording settings for each available device family. A device family is available when at least one encoder of this device family has been added to the Device Tree. In the **Cameras** table, you assign such a recording setting to each camera.

You use the Recording Schedules configured on the **Schedules** page.

Note: Switching on or off the normal recording is valid for all device families.

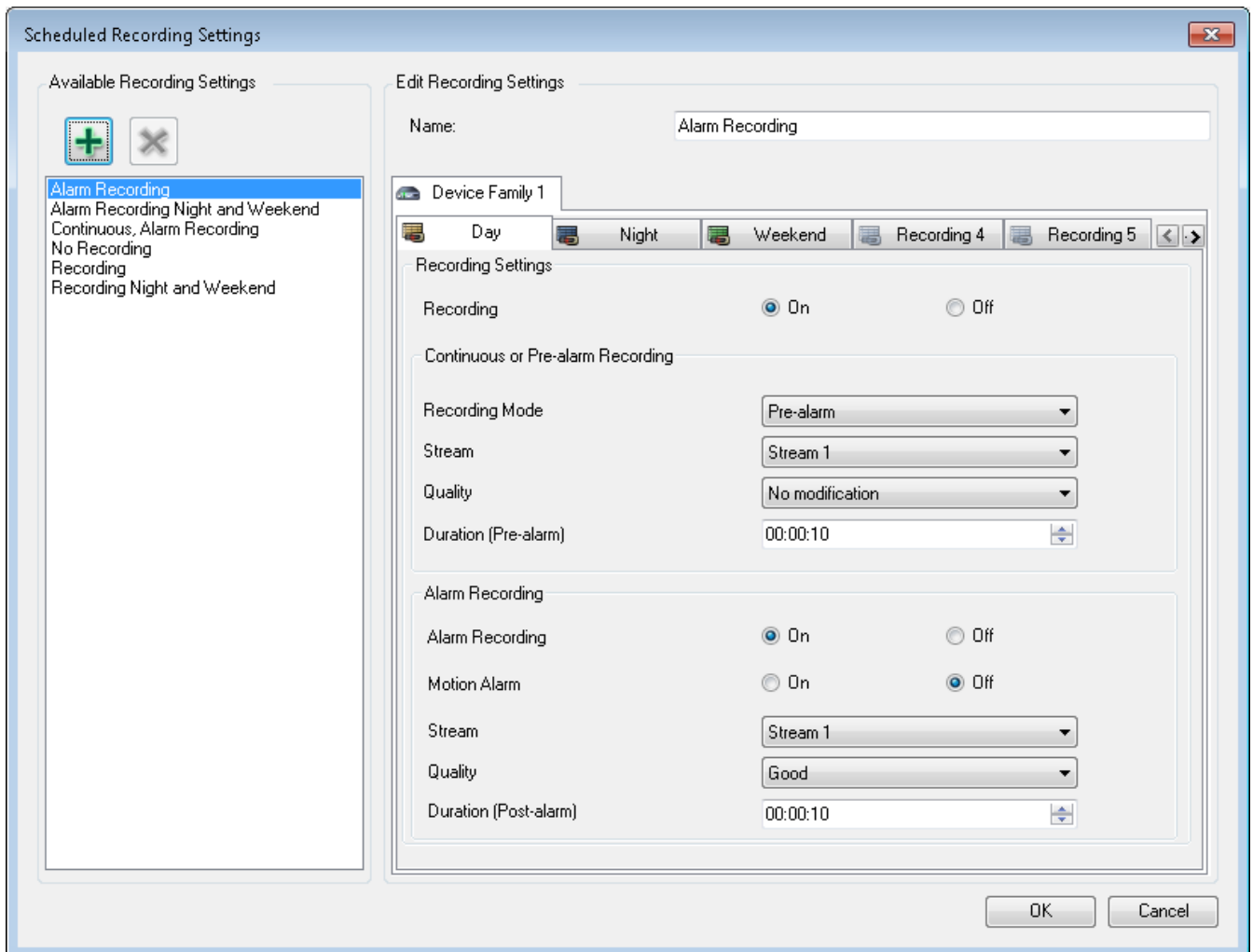

Available Recording Settings

Select a pre-defined recording setting to change its properties. You can add or delete a user-defined setting.

Name:

Type in a name for the new recording setting.



Select the desired device family to configure the recording settings valid for this device family.



For the selected device family, select a Recording Schedule to configure the recording settings.

Recording

Switch on or off the normal recording (continuous and prealarm).

Recording Mode

Select the desired recording mode.

The following items are available:

- **Continuous**
- **Pre-alarm**

Stream

Select the desired stream used for normal recording.

Note: It depends on the device family which streams are available.

Quality

Select the desired stream quality used for normal recording. The available quality settings are configured in the **Stream Quality Settings** dialog box.

Duration (pre-alarm)

Enter the desired recording time before an alarm. You enter the time in the format hh.mm.ss.

Note: Only enabled when **Pre-alarm** is selected.

**Notice!**

For pre-alarm settings between 1 and 10 s, the pre-alarms are automatically stored on the RAM of the encoder if enough RAM space is available, otherwise on the storage.

For pre-alarm settings greater than 10 s, pre-alarms are stored on the storage.

The storage of pre-alarms on the RAM of the encoder is only available for firmware version 5.0 or later.

Alarm Recording

Allows you to switch on or off the alarm recording for this camera.

Motion Alarm

Allows you to switch on or off alarm recording triggered by motion.

Stream

Select the stream used for alarm recording.

Note: It depends on the device family which streams are available.

Quality

Select the desired stream quality used for alarm recording. The available quality settings are configured in the **Stream Quality Settings** dialog box.

Only for devices belonging to Device Family 2 or 3: When you select the **No modification** entry, alarm recording uses the same quality as used for continuous/prealarm recording. We recommend using the **No modification** entry. When you select a stream quality for alarm recording, only the values for image encoding interval and target bit rate are modified according to the settings in this stream quality. The other quality settings are used that are configured in the quality setting assigned to the continuous/prealarm recording.

Duration (post-alarm)

Enter the desired alarm recording time. You enter the time in the format hh.mm.ss.

See also

- *Copying and pasting in tables, page 188*
- *Configuring recording settings (only VRM and Local Storage), page 190*

32.3**Recording settings pages (NVR only)**

Main window >  **Cameras and Recording** >  > Click a Recording Schedule tab

(for example )

Allows you to configure the recording settings for all encoders assigned to your system's NVR. The displayed Recording Schedules are configured in **Schedules**.

Only those columns are described that are not part of a Camera Table.

- ▶ Click a column title to sort the table by this column.

Continuous Recording

In the **Quality** column, click a cell to disable recording or to select the stream quality of stream 1.

In the  column, select a check box to activate audio.

Live/Pre-event Recording

In the **Quality** column, click a cell to select the stream quality of the live view (required for instant playback) and the pre-event recording (required for motion and alarm recording) mode of stream 2. If dual streaming is active on this encoder, you can select stream 1 to use for live or pre-event recording.

In the  column, select a check box to activate audio.

Motion Recording

In the **Quality** column, click a cell to disable recording or to select the stream quality of stream 1.

In the  column, click a cell to activate audio.

In the **Pre-event [s]** column, click a cell to select the recording time before the motion event in seconds.

In the **Post-event [s]** column, click a cell to select the recording time after the motion event in seconds.

Alarm Recording

In the **Quality** column, click a cell to select the stream quality of stream 1.

To enable alarm recording, configure a corresponding alarm.

In the  column, select a check box to activate audio.

In the **Pre-event [s]** column, click a cell to select the time before the alarm in seconds.

In the **Post-event [s]** column, click a cell to select the time after the alarm in seconds.

See also

- *Copying and pasting in tables, page 188*
- *Configuring recording settings (NVR only), page 191*

32.4 Stream Quality Settings dialog box

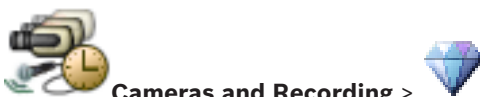

Main window > **Cameras and Recording** >

Allows you to configure stream quality profiles that you can later assign on the **Cameras and Recording** page to cameras or in the **Scheduled Recording Settings** dialog box.

A stream quality combines video resolution, frame rate, maximum bandwidth, and video compression.

Stream Qualities



Select a predefined stream quality and click  to add a new stream quality on the

basis of the predefined stream quality. When you select a single stream and click , this stream quality setting is copied as a childless top level node.



Click to delete a selected stream quality. You cannot delete the stream quality settings. The list displays all available predefined stream quality settings. We recommend assigning a stream quality with the same name as the platform of the camera.

The following profiles for stream qualities are available:

Image Optimized: The settings are optimized for image quality. This can burden the network.

Bit Rate Optimized: The settings are optimized for low bandwidth. This can reduce the image quality.

Balanced: The settings offer a compromise between optimal image quality and optimal bandwidth usage.

Name

Displays the name of the stream quality. When you add a new stream quality, you can change the name.

SD video resolution

Select the desired video resolution. For an HD quality you configure the SD quality of stream 2.

Image encoding interval

Move the slider or type the appropriate value.

The system helps you in calculating the corresponding value for IPS.

With the image encoding interval you configure the interval at which images are encoded and transmitted. If 1 is entered, all images are encoded. Entering 4 means that only every fourth image is encoded, the following three images are skipped - this can be particularly advantageous with low bandwidths. The lower the bandwidth the higher this value should be to achieve best-quality video.

Target bit rate [Kbps]

Move the slider or type the appropriate value.

You can limit the data rate for the encoder to optimize usage of bandwidth in your network. The target data rate should be set according to the desired picture quality for typical scenes with no excessive motion.

For complex images or frequent changes of image content due to frequent movements, this limit can be temporarily exceeded up to the value you enter in the **Maximum bit rate [Kbps]** field.

Maximum bit rate [Kbps]

Move the slider or type the appropriate value.

With the maximum bit rate you configure the maximum transmission speed which cannot be exceeded.

You set a bit rate limit to be able to reliably determine the appropriate disk space for storage of the video data.

Depending on the video quality settings for the I- and P-Frames, this fact can result in individual images being skipped.

The value entered here must be at least 10% higher than the value entered in the **Target bit rate [Kbps]** field. If the value entered here is too low, it will automatically be adjusted.

I-frame Distance

This parameter allows you to set the intervals in which the I-Frames are coded. Click **Automatic** to insert I-Frames as necessary. An entry of 1 indicates that I-Frames are continuously generated. An entry of 2 indicates that only every second image is an I-Frame, and 3 only every third image etc. The I-Frames in between are coded as P-Frames.

Frame Quality Level

Here you can set a value between 0 and 100 for both the I-Frames and the P-Frames. The lowest value results in the highest quality and the lowest frame refresh rate. The highest value results in the highest frame refresh rate and the lowest image quality.

The lower the available transmission bandwidth, the higher adjust the quality level to maintain high quality of the video.

Note:

You adjust the video quality dependent on the motion and level of detail in the video. If you check the **Automatic** check boxes, the optimum relationship between motion and image definition is automatically adjusted.

VIP X1600 XFM4 Settings

Allows you to configure the following H.264 settings for the VIP X 1600 XFM4 encoder module.

H.264 deblocking filter: Select to improve visual quality and prediction performance by smoothing the sharp edges.

CABAC: Select to activate high efficient compression. Uses a large amount of processing power.

See also

- *Configuring stream quality settings, page 189*

32.5

PTZ/ROI Settings dialog box



Allows you to configure a PTZ camera or a ROI camera.

For a ROI camera no auxiliary commands are available.

Note:

First configure the port settings of your PTZ camera before you can configure the PTZ camera settings. Otherwise the PTZ control is not working in this dialog box.

 Click to move the camera to the predefined position or to execute the command.

 Click to save the predefined position or command.



Click to rename the predefined position or command.



Click to remove the predefined position or command.

Predefined Positions tab

Click to display the table with the predefined positions.

Nr

Displays the number of the predefined position.

Name

Click a cell to edit the name of the predefined position.

Aux Commands tab (only for PTZ cameras)

Click to display the table with the auxiliary commands.

Nr

Displays the number of the auxiliary command.

Name

Click a cell to edit the name of the command.

Code

Click a cell to edit the command's code.

See also

- *Configuring PTZ port settings, page 192*
- *Configuring PTZ camera settings, page 193*

33 Events page



Main window > **Events**

Displays the Event Tree with all available events and an Event Configuration Table for each event. The events are grouped by their type, for example, all camera recording events like continuous recording or alarm recording are grouped under Recording Mode.

The available events are grouped beyond their corresponding devices. A state change of a device is displayed beyond as . All other events are displayed under device

dependant groups as .

You can configure for each event:

- Trigger an alarm according to a schedule (not available for all events).
- Log the event according to a schedule. An event is displayed in the Event List of the Operator Client if it is logged.
- Execute a Command Script according to a schedule (not available for all events).

- For events of type : Adding text data to recording.

If the event occurs, your settings are executed.

You can create a Compound Event which combines several events with Boolean expressions.

- ▶ Click a tree item to display the corresponding Event Configuration Table.



Click to duplicate an event. Use it to generate multiple alarms for a certain event.



Click to delete a duplicated or a Compound Event.



Click to rename the selected Compound Event.



Click to display a dialog box for creating Compound Events using Boolean expressions of other events (maximum 10).

Compound Events are added to the Event Configuration Table.



Click to edit the selected Compound Event.



Click to display a dialog box for creating and editing Command Scripts.



Type in a string and press the ENTER key to filter the displayed items. Only items containing the string and their corresponding parent items (only in trees) are displayed. The count of filtered items and the total count of items is provided. An

active filter is indicated by . Enclose strings with double quotes to find them exactly, for example "Camera 1" exactly filters the cameras with this name, not camera 201.

To cancel filtering, click .

See also

- *Configuring events and alarms, page 196*
- *Configuring Command Scripts, page 205*
- *Options dialog box, page 229*

– *Configuring blinking hot spots, page 204*

33.1 Debounce Settings tab

Note: For some events the Debounce Settings tab is not available due to technical limitations. Allows you to configure debounce settings for the selected event.

Debounce time

During the entered time period all further events are ignored.

Event state priority

For an event state you can assign a priority setting.

Edit Priorities

Click to display a dialog box for configuring a priority setting.

Add Setting



Click to add a row for configuring a debounce setting that is deviating from the debounce settings for all devices.

Remove Setting

Click to remove a selected row. To select a row click the left row header.

33.2 Settings tab for advanced map display

The configuration of the color states on maps is only possible when you click to check the **Enable advanced state display (hot spot coloring in maps depending on state)** option in the **Options** dialog box.

For each  event, you can configure the background color and the behavior (blinking or not blinking) for hot spots. For example you can configure for a  event of a device that its device icon on a map starts blinking when the state of this device changes.

Additionally you can configure the display priority for all hot spots. This is required when different events occur for the same device. (1 = highest priority)

The configured color is valid for all hot spots with the same display priority. You can change

color, behavior and priority at any  event: The changed color and behavior is used for all

hot spots of all other  events which have the same priority.

Enable color states on maps

Click to enable that the hot spots of the devices belonging to this event are displayed with colored background and can blink on maps.

Display priority on map:

Click the arrows to change the priority for the hot spots of the devices belonging to this event.

Background color on map:

Click the color field to select the background color used for the hot spots of the devices belonging to this event.

Note: All state events of all devices with the same priority have the same color.

Blinking

Click to enable blinking of the hot spots of the devices belonging to this event.

33.3 Settings tab for event configuration

Device

Displays the name of the device or schedule.

Network

Displays the IP address of the corresponding IP device.

Trigger Alarm

Click a cell to select a Recording or Task Schedule for triggering an alarm.

Select **Always** if you want the alarm to be triggered independently from the point in time.

Select **Never** if you do not want the alarm to be triggered.

Log

In the **Schedule** column, click a cell to select a Recording or Task Schedule for logging.

Select **Always** if you want the event to be logged independently from the point in time.

Select **Never** if you do not want the event to be logged.

Script

In the **Script** column, click a cell to select a Command Script.

In the **Schedule** column, click a cell to select a Recording or Task Schedule for executing a Command Script.

Select **Always** if you want the Command Script to be executed independently from the point in time.

Select **Never** if you do not want the Command Script to be executed.

Text Data Recording

You can configure that text data is added to the continuous recording of a camera.

Note: This column is available only for events that contain text data, for example: **ATM/POS Devices > ATM Input > Data Input**

33.4 Command Script Editor dialog box



Allows you to create and edit Command Scripts.



Click to save the changed settings.



Click to restore the saved settings.



Click to check the code of a script.



Click to create a scriptlet file.



Click to delete a scriptlet file.



Click to display a dialog box for importing a script file.



Click to display a dialog box for exporting a script file.



Click to convert an existing script to the other available script language. All existing script text is deleted.



Click to display the Online Help for Bosch VMS Script API.



Click to display the Online Help for Bosch VMS.



Click to close the **Command Script Editor** dialog box.

See also

- *Configuring Command Scripts, page 205*

33.5

Create Compound Event / Edit Compound Event dialog box



Main window >

Events >

Allows you to create or modify a Compound Event.



Type in a string and press the ENTER key to filter the displayed items. Only items containing the string and their corresponding parent items (only in trees) are displayed. The count of filtered items and the total count of items is provided. An

active filter is indicated by . Enclose strings with double quotes to find them exactly, for example "Camera 1" exactly filters the cameras with this name, not camera 201.

To cancel filtering, click .

Event name:

Type the required name for the Compound Event.

Event States:

Select the state change that shall be part of a Compound Event.

Objects:

Select one or more of the available objects of the selected event state. This state and the selected object appear in the Compound Event Tree, as immediate child of the root operator.

Compound Event:

Allows you to build compound events in the Compound Event Tree. All immediate children of a Boolean operator (AND, OR) are combined by this operator.

See also

- *Creating a Compound Event, page 199*
- *Editing a Compound Event, page 200*

33.6

Select Script Language dialog box



Main window >

Events >

Allows you to set the script language for your Command Scripts.

You cannot change the script language for existing Command Scripts.

Script Language:

Select the required script language.

See also

- *Configuring Command Scripts, page 205*

33.7 Edit Priorities of Event Type dialog box



Main window > **Events** > **Debounce Settings** tab > **Edit Priorities** button

You can configure priorities for the different state changes of an event type if applicable, for example Virtual Input Closed and Virtual Input Opened. A state change with higher priority overrides the debounce time of another state change with lower priority.

Name of Priority:

Type in a name for the priority setting.

State Value

Displays the names of the event states of the select event.

State Priority

Enter the desired priority. 1=highest priority, 10=lowest priority.

33.8 Select Devices dialog box



Main window > **Events** >  or  > **Debounce Settings** tab > **Add Setting** button

Select

Select the check box for the desired entry and click **OK** to add a row in the **Devices with Deviating Debounce Settings** table.

33.9 Text Data Recording dialog box



Main window > **Events** > In the Event Tree select  **Data Input** (text data must be available, for example: **Foyer Card Reader Devices** > **Foyer Card Reader** > **Card Rejected**) > **Text Data Recording** column > ...

You can configure the cameras for which text data is added to the continuous recording.

See also

- *Triggering alarm recording with text data, page 202*

34 Alarms page



Main window > **Alarms**

Displays the Event Tree and an Alarm Configuration Table for each event. Only the events configured on the **Events** page are displayed.

In the tables you configure for each event how an alarm triggered by this event is displayed and which cameras are recorded and displayed when this alarm occurs.

Some events are configured as alarms by default, e.g., a system error.

For the following events you cannot configure an alarm:

- Change of a recording mode
- Change of an alarm state
- Most of the user actions, e.g. PTZ action



Click to display the **Resource Manager** dialog box.



Displays a dialog box to set alarm settings valid for this Management Server.



Type in a string and press the ENTER key to filter the displayed items. Only items containing the string and their corresponding parent items (only in trees) are displayed. The count of filtered items and the total count of items is provided. An

active filter is indicated by . Enclose strings with double quotes to find them exactly, for example "Camera 1" exactly filters the cameras with this name, not camera 201.

To cancel filtering, click .

- ▶ Click a tree item to display the corresponding Alarm Configuration Table.

Device

Displays the device of the event condition selected in the Events Tree.

Network Address

Displays the IP address of the corresponding IP device.

Alarm Identity

In the **Priority** column, click in a cell to type the alarm priority for the selected alarm (**100** is low priority, **1** is high priority). In the **Title** column, click in a cell to type the title of the alarm to be displayed in Bosch VMS, for example in the Alarm List. In the **Color** column, click in a cell to display a dialog box for selecting a color for the alarm to be displayed in the Operator Client, for example in the Alarm List.

Alarm Image Panes

In one of the **1-5** columns, click ... in a cell to display a dialog box for selecting a camera. You can only select a camera that was added to the Logical Tree in **Maps and Structure**. You can configure the number of available Alarm Image panes in the **Alarm Settings** dialog box.

In the **Audio File** column, click ... in a cell to display a dialog box for selecting an audio file that is played in case of an alarm.

Alarm Options

Click ... in a cell to display the **Alarm Options** dialog box.

See also

- *Alarm handling, page 51*

34.1 Alarm Settings dialog box

Main window >  **Alarms** > 

Alarm Settings tab

Max. Image panes per alarm:

Enter the maximum count of Alarm Image panes to be displayed in case of an alarm.

Auto-clear time:

Enter the number of seconds until an alarm is automatically cleared.

This only applies for alarms that are set to **Auto-clear alarm after configured time ('Alarm Settings' dialog box)** in the **Alarms** page.

Manual alarm recording time:

Only valid for NVR recordings.

Enter the number of minutes for the duration of alarm recording that a user can start manually in the Operator Client.

The user can stop the manual recording before this time is elapsed.

Analog Monitor Groups tab

Display order in case of same alarm priority

Select the desired entry for sorting alarms of the same priority according to their time stamp.

Show blank screen

Click to configure that on a monitor not being used for alarm display nothing is shown.



Continue live display

Click to configure that on a monitor not being used for alarm display live display is shown.

See also

– *Configuring settings for all alarms, page 201*

34.2 Select Image Pane Content dialog box

Main window >  **Alarms** >  or  > **Alarm Image Panes** column > Click ... in one of the **1-5** columns

Allows you to select the Logical tree item that is displayed and recorded (if the item is a camera) in case of the selected alarm.



Notice!

A map displayed in an Alarm Image pane is optimized for display and contains only the initial view of the basic .dwf file.

Search Item

Enter text to find an item in the Logical Tree.

Find

Click to find the camera with the entered search text in its description.

Live

Click to determine that the live image of the camera is displayed in case of an alarm.

Instant playback

Click to determine that instant playback of the camera is displayed.

The rewind time for instant playback is configured in the **Alarm Settings** dialog box, see *Alarm Settings dialog box, page 365*.

Pause playback

Select the check box to display the alarm instant playback camera with paused instant playback. The user can start instant playback if needed.



Record this camera

Select the check box to enable alarm recording for this camera in case of an alarm. If an alarm is triggered, this camera is recorded in alarm recording quality. The duration of the recording is the duration of the alarm state plus pre- and post-alarm time. This setting directly changes the setting for alarm recording in the **Alarm Options** dialog box and vice versa.

See also

- *Configuring an alarm, page 201*

34.3**Select Resource dialog box**

Main window >  **Alarms** >  or  > **Alarm Image Panes** column > **Audio File** column > Click ...

Allows you to select an audio file that is played in case of an alarm.

Play

Click to play the selected audio file.

Pause

Click to pause the selected audio file.

Stop

Click to stop the selected audio file.



Manage...

Click to display the **Resource Manager** dialog box.

See also

- *Configuring an alarm, page 201*
- *Managing resource files, page 197*

34.4**Alarm Options dialog box**

Main window >  **Alarms** >  or  > **Alarm Options** column > ...

Allows you to configure the following settings for alarms:

- Cameras that start recording in case of an alarm.
- Enabling protection for these alarm recordings.
- Enabling and configuring deviating alarm duration settings.
- Triggering PTZ commands in case of alarm.
- Notifications that are sent in case of an alarm.
- Workflow that has to be processed in case of an alarm.
- Assigning cameras that are displayed in analog monitor groups in case of an alarm.

Cameras tab**Nr**

Displays the camera number as configured on the **Cameras and Recording** page.

Name

Displays the camera name as configured on the **Cameras and Recording** page.

Location

Displays the location as configured on the **Maps and Structure** page.

Record

Select a check box to enable alarm recording for this camera in case of an alarm. If an alarm is triggered, this camera is recorded in alarm recording quality. The duration of the recording is the duration of the alarm state plus pre- and post-alarm time. This setting directly changes the setting for alarm recording in the **Select Image Pane Content** dialog box and vice versa.

Protect Recording

Select a check box to protect the alarm recording of this camera.

Deviating Alarm Duration Settings

The check box is automatically enabled when you enable the **Record** check box and when the camera supports ANR.

Auxiliary Command

Click a cell to select an auxiliary command to be executed in case of an alarm. Entries in this list are only available for a PTZ camera.

Predefined Position

Click a cell to select a predefined position to be set in case of an alarm. Entries in this list are only available for a PTZ camera.

Notifications tab**E-mail**

Select the check box to send an e-mail in case of an alarm.

Server:

Select an e-mail server.

Recipients:

Type the e-mail addresses of the recipients separated by commas (example: name@provider.com).

SMS

Select the check box to send an SMS in case of an alarm.

Device:

Select an SMS device.

Recipients:

Type the mobile numbers of the recipients.

Text:

Type the text of the notification.

Information:

Select the check box to add the corresponding information to the notification text.

Note: For an e-mail the date of the time zone of the Management Server is used.

Workflow tab**Record only alarm**

Select the check box to specify that the camera is only recorded and not being displayed in case of this alarm. This check box is only active if the **Record** check box on the **Cameras** tab is selected.

Auto-clear alarm after configured time ('Alarm Settings' dialog box)

Select the check box to specify that this alarm is automatically cleared.

Auto-clear alarm when event state changes back to normal

Select the check box to specify that this alarm is automatically cleared when the event that triggers this alarm changes its state. The alarm will not be cleared automatically if it is accepted and unaccepted.

Show action plan

Select the check box to enable the workflow that must be processed in case of an alarm.

Resources...

Click to display the **Resource Manager** dialog box. Select a document with a description of the corresponding workflow.

Display a comment box

Select the check box to enable displaying a comment box in case of an alarm. In this comment box the user can type comments on the alarm.

Force the operator to process the workflow

Select the check box to force the user to process the workflow. If selected, the user cannot clear the alarm until he has entered a comment on the alarm.

Execute the following Client Script when alarm is accepted:

Select a Client Command Script that is executed automatically, when the user accepts an alarm.

Analog Monitor Group tab**1...10**

In a numbered column, click a cell and select a camera from the Logical Tree. This camera will be displayed in the assigned monitor in case of an alarm.

Clear Table

Click to remove all camera assignments to analog monitor groups.

Alarm title

Select the check box to configure that the title of the alarm is displayed on the analog monitors as an on-screen display.

Alarm time

Select the check box to configure that the time of the alarm is displayed on the analog monitors as an on-screen display.

Alarm date

Select the check box to configure that the date of the alarm is displayed on the analog monitors as an on-screen display.

Alarm camera name

Select the check box to configure that the name of the alarm camera is displayed on the analog monitors as an on-screen display.

Alarm camera number

Select the check box to configure that the number of the alarm camera is displayed on the analog monitors as an on-screen display.

Only on 1st monitor

Select the check box to configure that the title and the time of the alarm is displayed only on the first monitor of the analog monitor group as an on-screen display.

Deviating Alarm Duration Settings tab

The settings on this tab are only available if ANR is enabled for this camera.

Use profile settings

Click to enable this setting. For this camera the pre-alarm and post-alarm duration settings are used that are configured in the **Scheduled Recording Settings** dialog box.

Override settings

Click to enable the following settings for pre-alarm and post-alarm duration.

Duration (pre-alarm)

Available for all events.

Duration (post-alarm)

Only available for  events.

See also

- *Triggering alarm recording with text data, page 202*
- *Configuring an alarm, page 201*
- *Configuring the pre- and post-alarm duration for an alarm, page 202*

35 User Groups page



Main window > **User Groups**

The following user group is available by default:

- Admin Group (user name: Admin)

Allows you to configure user groups, Enterprise User Groups and Enterprise Access.

User Groups tab

Click to display the pages available for configuring the rights of the standard user group.

Enterprise User Group tab (only available with valid Enterprise license)

Click to display the pages available for configuring the permissions of an Enterprise User Group.

Enterprise Access tab (only available with valid Enterprise license)

Click to display the pages available for adding and configuring Enterprise Access.



Click to delete a selected entry.



Click to add a new group or account.



Click to add a new user to the selected user group. Change the default user name if desired.



Click to add a new dual authorization group.



Click to add a new logon pair for dual authorization.



Displays a dialog box for copying permissions from a selected user group to another user group.



Click to display the pages available for configuring the permissions of this group.



Click to display the page available for configuring the properties of this user.



Click to display the page available for configuring the properties of this logon pair.



Click to display the pages available for configuring the permissions of this dual authorization group.

Permissions on an Enterprise System

For an Enterprise System you configure the following permissions:

- Operating permissions of Operator Client defining the user interface for operating in the Enterprise System, for example the user interface of the alarm monitor.
Use an Enterprise User Group. Configure it on the Enterprise Management Server.
- Device permissions that should be available for operating in an Enterprise Management Server are defined on each Management Server.
Use Enterprise Accounts. Configure it on each Management Server.

Permissions on a single Management Server

For managing the access to one of the Management Servers, use the standard user group. You configure all permissions on this Management Server in this user group. You can configure dual authorization user groups for standard user groups and for Enterprise User Groups.

Type	Contains	Available configuration settings	Where do you configure?
User group	Users	– Operating and device permissions	– Management Server
Enterprise User Group	Users	– Operating permissions – Per Management Server: Name of the corresponding Enterprise Access Accounts with logon credentials	– Enterprise Management Server
Enterprise Account	-	– Device permissions – Account password	– Management Server
Dual authorization user group	User groups	– See user groups	– See user groups
Enterprise dual authorization	Enterprise User Groups	– See Enterprise User Groups	– See Enterprise User Groups



Type in a string and press the ENTER key to filter the displayed items. Only items containing the string and their corresponding parent items (only in trees) are displayed. The count of filtered items and the total count of items is provided. An active filter is indicated by . Enclose strings with double quotes to find them exactly, for example "Camera 1" exactly filters the cameras with this name, not camera 201. To cancel filtering, click .

35.1

New User Group/Enterprise Account dialog box

Main window > **User Groups** > **User Groups** tab >

or

Main window > **User Groups** > **Enterprise User Group** tab >

or

Main window > **User Groups** > **Enterprise Access** tab >

Allows you to create a standard user group, an Enterprise User Group or an Enterprise Account.

The Enterprise User Groups tab is only available if the appropriate license is available and if



one or more Management Server computers are configured in **Devices > Enterprise System > Server List / Address Book**.

Name

Type in a name for the group or account.

Description

Type in a description for the group or account.

For Enterprise Accounts:

Password

Type in a password.

Confirm password

Enter the new password again.

See also

- *Creating a group or account, page 209*

35.2

User Group Properties page



Main window > **User Groups > User Groups tab >**  > **Operating Permissions tab > User Group Properties tab**

or



Main window > **User Groups > Enterprise User Group tab >**  > **Operating Permissions tab > User Group Properties tab**

Allows you to configure the following settings for the selected user group:

- Logon schedule
- Association of an LDAP user group

Description:

Type an informative description for the user group.

Language

Select the language of the Operator Client.

Logon schedule

Select a task or recording schedule. The users of the selected group can only log on to the system in the times defined by this schedule.

Associated LDAP group

Type the name of the LDAP user group that you want to use for your system.

You can also double-click an item in the **LDAP groups** list.

LDAP groups

Displays the available LDAP user groups. You configure LDAP groups in the **LDAP Server Settings** dialog box.

Search for Groups

Click to display the available LDAP user groups in the **LDAP groups** list. To find user groups you must make the appropriate settings in the **LDAP Server Settings** dialog box.

Settings

Click to display the **LDAP Server Settings** dialog box.

Associate Group

Click to associate the selected LDAP group with this user group.

Clear Group



Click to clear the **Associated LDAP group** field. The association of the LDAP group to the Bosch VMS user group is removed.

See also

- *Configuring LDAP settings, page 210*
- *Associating an LDAP group, page 211*
- *Scheduling user logon permission, page 211*

35.3

User Properties page

Main window >  **User Groups > User Groups tab**  > 

or

Main window >  **User Groups > Enterprise User Group tab** >  > 

If you change the password for a user or delete a user while this user is logged on, this user can still continue working with Operator Client after password change or deletion. If after password change or deletion the connection to Management Server is interrupted (for example after activating the configuration), the user cannot automatically reconnect to the Management Server again without logoff/logon at Operator Client.

Allows you to configure a new user in a standard user group or in an Enterprise User Group.

Full name

Type the full name of the user.

Description:

Type an informative description for the user.

Strong password policy

Select the check box to enable the system to check for a secure password.

The following rules apply:

- Minimum 8 characters.
- At least one upper-case letter (A through Z).
- At least one number (0 through 9).
- At least one special character (for example: ! \$ # %).
- Previous password must not be used.

Enter new password

Type the password for the new user.



Confirm password:



Type the new password again.

Apply

Click to apply the settings.

35.4**Add New Dual Authorization Group dialog box**

Main window >  **User Groups > User Groups tab >** 
or

Main window >  **User Groups > Enterprise User Group tab >** 
Allows to create a dual authorization for a standard user group or for an Enterprise User Group.

For Enterprise Access, a dual authorization is not available.

Name:

Type in a name for the group.

Description:

Type in description for the group.



See also

- *Creating a dual authorization group, page 210*

35.5**Logon Pair Properties page**

Main window >  **User Groups > User Groups tab >**  **New Dual Authorization**

Group >  
or

Main window >  **User Groups > Enterprise User Group tab >**  **New Enterprise**
Dual Authorization Group >  

Allows you to modify a pair of user groups to a dual authorization group. The users of the first user group are the users that must log on in the first dialog box for logging on, the users of the second user group confirm the logon.

Select Logon Pair

In each list, select a user group.



Force dual authorization

Select the check box to force each user to log on only together with a user of the second user group.

See also

- *Creating a dual authorization group, page 210*

35.6 Select User Groups dialog box

Main window >  **User Groups** > **User Groups** tab >  **New Dual Authorization**

Group > 
or

Main window >  **User Groups** > **Enterprise User Group** tab >  **New Enterprise**

Dual Authorization Group > 

Allows you to add a pair of user groups to a dual authorization group. The users of the first user group are the users that must log on in the first dialog box for logging on, the users of the second user group confirm the logon.

Select Logon Pair

In each list, select a user group.



Force dual authorization

Select the check box to force each user to log on only together with a user of the second user group.

See also

- *Creating a dual authorization group, page 210*

35.7 Camera Permissions page

Main window >  **User Groups** > **User Groups** tab >  > **Device Permissions** tab > **Camera Permissions** tab
or

Main window >  **User Groups** > **Enterprise Access** tab >  > **Device Permissions** tab > **Camera Permissions** tab

Allows you to configure the access rights for the features of a selected camera or camera group for the selected user group.

If new components are added, camera permissions must be configured afterwards.

You can recall the access to a camera on the **Camera** page.

Camera

Displays the camera name as configured on the **Cameras and Recording** page.

Location

Displays the location of the camera as configured on the **Maps and Structure** page.

Access

Select a check box to allow access to this camera.

Live Video

Select a check box to allow using live video.

Live Audio

Select a check box to allow using live audio.

Manual Recording

Select a check box to allow manual recording (alarm recording).

You can select or clear this check box only when the manual alarm recording is enabled on the **Operator Features** page.

Playback Video

Select a check box to allow using playback video.

You can select or clear this check box only when playback is enabled on the **Operator Features** page.

Playback Audio

Select a check box to allow using playback audio.

You can select or clear this check box only when playback is enabled on the **Operator Features** page.

Text Data

Select a check box to allow displaying metadata.

You can select or clear this check box only when the display of metadata is enabled on the **Operator Features** page.

Export

Select a check box to allow exporting video data.

You can select or clear this check box only when the export of video data is enabled on the **Operator Features** page.

PTZ/ROI

Select a check box to allow using the PTZ control or the ROI of this camera.

You can select or clear this check box only when the PTZ control or ROI of this camera is enabled on the **Operator Features** page. Additionally you must configure PTZ or ROI in the Camera Table.

Aux

Select a check box to allow executing auxiliary commands.

You can select or clear this check box only when the PTZ control of a camera is enabled on the **Operator Features** page.

Set Presets

Select a check box to allow the user to set prepositions of this PTZ camera.

You can also set prepositions for the Region of Interest feature, if enabled and authorized.

You can select or clear this check box only when the PTZ control of a camera is enabled on the **Operator Features** page.

Reference Image

Select a check box to allow updating the reference image of this camera.

See also

- *Configuring camera permissions, page 214*

35.8

Control Priorities



Main window >

Control Priorities tab

User Groups > User Groups tab >



Device Permissions tab >

or

 Main window > **User Groups** > **Enterprise Access** tab >  > **Device Permissions** tab > **Control Priorities** tab

Control Priorities

Move the appropriate slider to the right to decrease the priority for acquiring PTZ controls and Bosch Allegiant trunk lines. A user with a high priority can lock the PTZ controls or the control of a trunk line for users with lower priorities. You set the timeout for locking PTZ control on the **Timeout in min.** field. The default setting is 1 minute.



Timeout in min.

Enter the time period in minutes.



See also

– *Configuring various priorities, page 214*

35.9 Copy User Group Permissions dialog box

 Main window > **User Groups** > **User Groups** tab >  > 

or

 Main window > **User Groups** > **Enterprise User Group** tab >  > 

Allows you to select user group permissions to be copied to selected user groups.

Copy from:

Displays the selected user group. Its permissions are to be copied to another user group.

Settings to Copy

Select a check box to select the desired user group permissions for copying.

Copy to:

Select a check box to specify the user group where to copy the selected user group permissions to.



See also

– *Copying user group permissions, page 215*

35.10 Decoder Permissions page

Main window > **User Groups** > **User Groups** tab >  > **Device Permissions** tab > **Camera Permissions** tab

or

 Main window > **User Groups** > **Enterprise Access** tab >  > **Device Permissions** tab > **Camera Permissions** tab

Allows you to configure the decoders that the users of this group have access to.

Decoder



Displays the available decoders.

Click the check box to give the user group access to this decoder.

See also

- *Configuring decoder permissions, page 214*

35.11 Events and Alarms page

Main window >  **User Groups > User Groups tab >  > Device Permissions tab > Events and Alarms tab**
or

Main window >  **User Groups > Enterprise Access tab >  > Device Permissions tab > Events and Alarms tab**

Allows to configure the permissions for the Events Tree, i.e. you set the events the user group is authorized or not authorized to use.



For each event there is at least one device. For example, for the **Video Loss** event the available cameras are the devices. For an event like **Backup Finished** the corresponding device is **Time Controlled Backup**. Hence, a device can be a software process.

1. Expand a tree item and click the required check boxes for enabling the events. In the **Access** column, select the check box of a device to enable the events of this device. The access to the devices is configured on the **Camera** page and on the **Camera Permissions** page.
2. To enable or disable all events at once, select or clear the **Events and Alarms** check box.

See also

- *Configuring permissions for events and alarms, page 213*

35.12 LDAP Server Settings dialog box

Main window >  **User Groups > User Groups tab >  > Operating Permissions tab > User Group Properties tab > Settings button**
or

Main window >  **User Groups > Enterprise User Group tab >  > Operating Permissions tab > User Group Properties tab > Settings button**

You enter the LDAP server settings that are configured outside of Bosch VMS. You will need the assistance of your IT administrator who set up the LDAP server for the following entries. All fields are mandatory except the fields in the **Test User / User Group** group box.

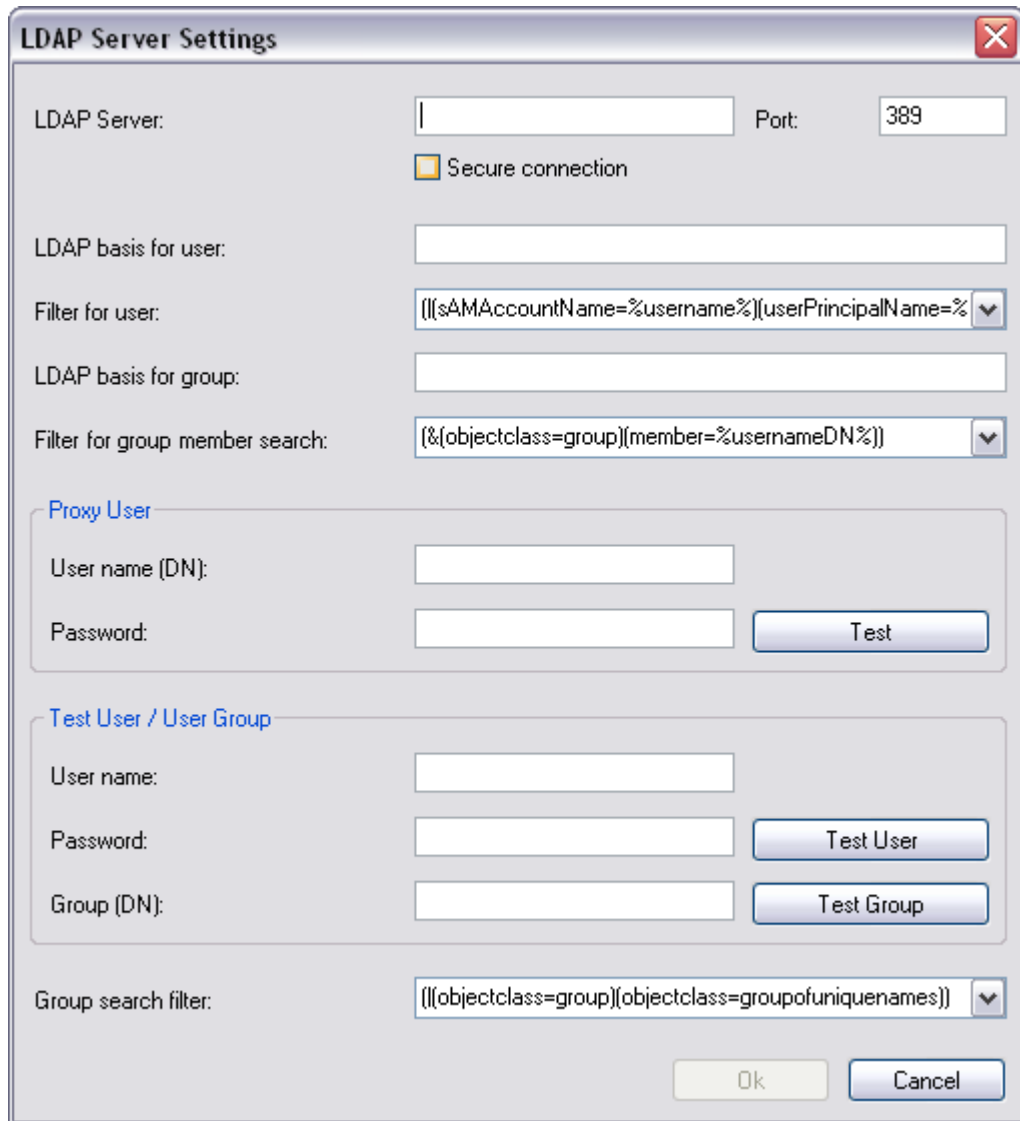

LDAP Server Settings

LDAP Server:

Type the name of the LDAP server.

Port

Type the port number of the LDAP server (default unencrypted: 389, encrypted: 636)

Secure connection

Select the check box to activate encrypted data transmission.

LDAP basis for user:

Type the unique name (DN = distinguished name) of the LDAP path in which you can search for a user. Example for a DN of the LDAP

basis:CN=Users,DC=Security,DC=MyCompany,DC=com

Filter for user:

Select a filter used to search for a unique user name. Examples are predefined. Replace %username% with the actual user name.

LDAP basis for group:

Type the unique name of the LDAP path in which you can search for groups.

Example for a DN of the LDAP basis: CN=Users,DC=Security,DC=MyCompany,DC=com

Filter for group member search:

Select a filter used to search for a group member.

Examples are predefined. Replace %usernameDN% with the actual user name and his DN.

Proxy User**User name (DN):**

Type the unique name of the proxy user. This user is required to allow the users of this Bosch VMS user group to access the LDAP server.

Password:

Type the proxy user password.

Test

Click to test whether the proxy user has access to the LDAP server.

Test User / User Group

The entries in this group box are not saved after clicking **OK**. They only serve for testing.

User name:

Type the name of a test user. Omit the DN.

Password:

Type the test user password.

Test User

Click to test whether the combination of user name and password is correct.

Group (DN):

Type the unique group name with which the user is associated.

Test Group

Click to test the association of the user with the group.

Group search filter:

Do not leave this field empty. If there is no entry, you cannot assign an LDAP group to a Bosch VMS user group.

Select a filter to find a user group.

Examples are predefined.

See also

– *Configuring LDAP settings, page 210*

35.13

Credentials page

Main window > **User Groups** > **Enterprise Access** tab >  > **Device Permissions** tab > **Credentials** tab

Configure the credentials of an Enterprise Account on a Management Server.

You configure Enterprise Access on each Management Server that is member of your Enterprise System. The Enterprise Management Server uses this credential to grant access to the devices of this Management Server for the Operator Client that logs on as a user of an Enterprise User Group.

Rename the  item as desired. This is the name of the Enterprise Account.

Description:

Type in a description for this Enterprise Account.



Enter new password: / Confirm password:

Type in and confirm the password for this Management Server.

See also

- *New User Group/Enterprise Account dialog box, page 371*

35.14 Logical Tree page

Main window >  **User Groups > User Groups tab >**  **> Device Permissions tab > Camera tab**
or

Main window >  **User Groups > Enterprise Access tab >**  **> Device Permissions tab > Camera tab**

Allows you to configure the Logical Tree for each user group.

Camera



Select a check box to give the users of the selected user group access to the corresponding devices.



You can recall the access to a camera on the **Camera Permissions** page.

See also

- *Configuring permissions for Logical Tree, page 213*

35.15 Operator Features page

Main window >  **User Groups > User Groups tab >**  **> Operating Permissions tab > Operator Features tab**
or

Main window >  **User Groups > Enterprise User Group tab >**  **> Operating Permissions tab > Operator Features tab**

Allows you to configure various permissions for the selected user group.

PTZ control of dome cameras

Select the check box to allow the control of a camera.

Control Priorities page: In the **Control Priorities** field, you can set the priority for acquiring the control of a camera.

Allegiant trunk lines

Select the check box to allow accessing Bosch Allegiant trunk lines.

Control Priorities page: In the **Control Priorities** field, you can set the priority for acquiring Bosch Allegiant trunk lines.

Print and save video

Select the check box to allow printing and saving video data.

Alarm processing

Select the check box to allow alarm processing.

Interrupt the Windows Screen Saver for incoming alarms

Select the check box to ensure that an incoming alarm is displayed even when the screen saver is active. If the screen saver requires a user name and password for being interrupted, this setting has no effect.

Alarm display

Select the check box to allow alarm display. If you select this option, the **Alarm processing** is deactivated simultaneously.

Playback

Select the check box to allow various playback features.

Export video

Select the check box to allow exporting video data.

Export MOV / ASF video

Select the check box to allow exporting video data in ASF and MOV format.

Protect video

Select the check box to allow protecting video data.

Unprotect video

Select the check box to allow both protecting and unprotecting video data.

**Notice!**

Configure the permissions for restricting and unrestricting or a user account on your DIVAR AN device as required. Create a user in Bosch VMS with the same credentials and configure the permissions for restricting and unrestricting accordingly.

Display of restricted video is not affected and must be configured separately.

Restrict video

Select the check box to allow restricting video data.

Unrestrict video

Select the check box to allow both restricting and unrestricting video data.

Delete video

Select the check box to allow deleting video data.

Access to video that has been recorded in periods when the user group has not been allowed to log on

Select the check box to allow accessing the described video data.

Logbook access

Select the check box to allow accessing the Logbook.

Operator event buttons

Select the check box to allow user event buttons in the Operator Client.

Close Operator Client

Select the check box to allow closing the Operator Client.

Minimize Operator Client

Select the check box to allow minimizing the Operator Client.

Audio Intercom

Select the check box to allow the user to speak on the loudspeakers of an encoder with audio-in and audio-out function.

Manual Alarm Recording

Select the check box to allow manual alarm recording.

Access VRM Monitor

Select the check box to allow access to the VRM Monitor software.

Set reference image

Select the check box to allow updating the reference image in the Operator Client.

Set area selection for reference image

Select the check box to allow selecting the area in the camera image for updating the reference image in the Operator Client.

Change password

Select the check box to allow a user of Operator Client to change the password for logging on.

Arm intrusion panel areas

Select the check box to allow a user of Operator Client to arm areas configured in an intrusion panel that is part of your Bosch VMS configuration.

Force arm intrusion panel areas

Select the check box to allow a user of Operator Client to force the arming of areas configured in an intrusion panel that is part of your Bosch VMS configuration.

Disarm intrusion panel areas

Select the check box to allow a user of Operator Client to disarm areas configured in an intrusion panel that is part of your Bosch VMS configuration.

Silence bells for intrusion panel areas

Select the check box to allow a user of Operator Client to switch off alarm sirens of areas configured in an intrusion panel that is part of your Bosch VMS configuration.

Bypass intrusion panel points

Select the check box to allow a user of Operator Client to change the state of a point configured in an intrusion panel to the **Point bypassed** state. A bypassed point cannot send an alarm. When the state is changed back to **Point unbypassed**, a pending alarm is sent if available

Unlock intrusion panel doors

Select the check box to allow a user of Operator Client to unlock a door configured in an intrusion panel.

Secure and unsecure intrusion panel doors

Select the check box to allow a user of Operator Client to secure and unsecure a door configured in an intrusion panel.

Cycle intrusion panel doors

Select the check box to allow a user of Operator Client to cycle a door configured in an intrusion panel.

Display order in case of same alarm priority

Select the appropriate value to configure the order of Alarm Image panes in the Alarm Display of the Operator Client.

Instant playback rewind time:

Enter the number of seconds for the duration of instant playback.

Repeat alarm audio:

Select the check box and enter the number of seconds after an alarm sound is repeated.

Limit access to recorded video to the last n minutes:

Select the check box to limit the access to recorded videos.

In the list, enter the number of minutes.



Enforce automatic Operator logoff after this time of inactivity:

Select the check box to enable the automatic logoff of Operator Client after the configured time period.



See also

- *Inactivity logoff, page 56*
- *Configuring operating permissions, page 212*

35.16**Priorities page**

Main window >  **User Groups > User Groups tab >  > Operating Permissions tab > **Priorities** tab**

or

Main window >  **User Groups > Enterprise User Group tab >  > Operating Permissions tab > **Priorities** tab**

Allows you to configure the timeout for explicit PTZ locking. You can set the priorities for PTZ control and the display of incoming alarms.

Automatic Popup Behavior



Move the slider to adjust the priority value of Live Image window or Playback Image window. This value is required for incoming alarms to decide whether this alarm is automatically displayed in the Alarm Image window.

For example: If you move the slider for Live Image window to 50 and for the Playback Display to 70 and an alarm comes in with a priority of 60, the alarm is only automatically displayed if the user has Playback Display active. The alarm is not automatically displayed when the user has Live Display active.



See also

- *Configuring various priorities, page 214*

35.17**User Interface page**

Main window >  **User Groups > User Groups tab >  > Operating Permissions tab > **User Interface** tab**

or

Main window >  **User Groups > Enterprise User Group tab >  > Operating Permissions tab > **User Interface** tab**

Allows you to configure the user interface of 4 monitors used by Operator Client.

Control Monitor

Select the control monitor which displays Live Mode only.

Alarm Monitor

Select the alarm monitor which can display either Live and Alarm Mode or only Alarm Mode.

Monitor 1 - 4

In the corresponding list, select the required entry.

The following entries are available:

- **Live only Image window**
- **Map and document window**
- **Two map and document windows**
- **Fullscreen Live Image window**
- **Quad Live Image window**

Image panes aspect ratio

For each monitor select the required aspect ratio for the initial startup of Operator Client. Use 16:9 for HD cameras.

Save settings when shutting down

Select the check box to activate that the system remembers the last state of the user interface when the user logs off from the Operator Client. If the check box is not selected, the Operator Client starts always with the configured user interface.

Restore Default

Click to restore the default settings of this page.

Load Custom Layout

Click to import an XML file with user interface settings.

Unload Custom Layout

Click to display a dialog box for unloading imported interface settings.

See also

- *Configuring user interface settings, page 212*

35.18**Server Access page**

Main window >  **User Groups > Enterprise User Group tab >  > Server Access tab**

You configure the server access on an Enterprise Management Server.

You enter the name of the Enterprise Account and its password for each Management Server of your Enterprise System. This account is configured on each Management Server.

Management Server

Displays the name of the Management Server that you configured on this Enterprise Management Server.

Management Server

Displays the name of the Management Server that has been added to the Server List



(Main window >  **Devices > Enterprise System > Server List / Address Book).**

Private Network Address

Displays the private IP address or DNS name of the Management Server.

Public Network Address

Displays the public IP address or DNS name of the Management Server.

Server Number

Displays the number of the Management Server. This number is used by an IntuiKey keyboard to select the desired Management Server.

Access

Click to check when you want to grant access to the Management Server. This Management Server is now an Enterprise Management Server.

Enterprise Account

Type in the name of the Enterprise Account that has been configured on the Management Server.

Enterprise Account Password

Click to display a dialog box for typing in the password of the Enterprise Account that has been configured on the Management Server.

Server Description

Displays the descriptive text for this server.

Further columns are displayed if they have been added to the Server List.

See also

- *Creating a group or account, page 209*
- *Creating an Enterprise System , page 114*
- *Configuring the Server List for Enterprise System, page 119*

36 Troubleshooting

This chapter contains information on how to handle known problems using Bosch VMS Configuration Client.

Problems after updating Bosch Video Management System

Issue	Cause	Solution
The NVR does not record after updating Bosch Video Management System.	The connection between NVR and Management Server was lost after the update. The update can potentially have changed the Bosch VMS database on the Management Server. The NVR must “know” these changes.	Reestablish the connection between NVR and Management Server.

Problems during installation

Issue	Cause	Solution
Setup displays wrong characters.	The Windows language settings are not correct.	<i>Configuring the desired language in Windows, page 389</i>
Setup stops with a message that OPC Server cannot be installed.	OPC Server files cannot be overwritten.	Uninstall OPC Core Components Redistributable and restart Bosch VMS Setup.
The software cannot be uninstalled by executing Setup.		Start Control Panel > Add/Remove Programs and uninstall Bosch VMS.

Problems immediately after starting the application

Issue	Cause	Solution
Bosch VMS displays the wrong language.	Windows is not switched to the desired language.	<i>Configuring the language of Configuration Client, page 100</i> or <i>Configuring the language of Operator Client, page 100</i>
The logon dialog box of Operator Client shows the wrong language.	Although you have changed the language for Operator Client in Configuration Client, the language for the logon dialog box of Operator Client depends on the Windows language.	<i>Configuring the desired language in Windows, page 389</i>

Problems with display language

Issue	Cause	Solution
Some display texts in Configuration Client or Operator Client are in a foreign language, usually English.	The OS language of the computer where the Management Server is installed, is often English. Hence, when the Bosch VMS database is generated on this computer, many display texts are created in English. They remain unchanged regardless of the Windows language of an Operator Client computer. To avoid such language discrepancies, install Management Server software on a computer with the desired Windows interface language.	Do not change this.

Problems with Bosch IntuiKey keyboard

Issue	Cause	Solution
The Bosch IntuiKey keyboard triggers an alarm and the softkey display displays Off Line.	The connection to the workstation is lost. Either the cable is damaged or unplugged, or the workstation has been reset.	<i>Reestablishing the connection to a Bosch IntuiKey keyboard, page 389</i>

Problems with the settings in the recording control of your soundcard

Issue	Cause	Solution
Feedbacks occur when using a microphone for Intercom functionality.	In the recording control of your soundcard the microphone must be selected, not the stereo mix (or something else). Operator Client checks its configuration file during startup and changes the settings in the recording control accordingly. This configuration file contains a default entry which might not match your system configuration. This setting is restored during each start of Operator Client.	Change the setting in the configuration file of Operator Client to microphone.

Crashing Configuration Client

Issue	Cause	Solution
Configuration Client crashes.	If there are many cameras configured in an Allegiant file which are not connected to Bosch Video Management System, you can reduce this number. This avoids unnecessary system load.	See <i>Reducing the number of Allegiant cameras</i> , page 389.

Crashing Operator Client

Issue	Cause	Solution
Operator Client crashes.	DiBos Web client is installed and has been started on the computer where Operator Client is installed.	Uninstall the DiBos Web client.

36.1 Configuring the desired language in Windows

If you want to change the display language for the setup of Bosch VMS, you must switch the language in your Windows. For activating the language settings the computer is restarted after performing the following steps.

To configure the desired language:

1. Click **Start**, click **Control Panel**, and then double-click **Regional and Language Options**.
2. Click the **Advanced** tab, under **Language for non-Unicode programs**, select the desired language.
3. Click **OK**.
4. In each of the next message boxes, click **Yes**.
Your computer is restarted.

36.2 Reestablishing the connection to a Bosch IntuiKey keyboard

1. Plug in the cable again or wait until the workstation is online.
The Off Line message disappears.
2. Press the Terminal softkey to enter Bosch VMS.

36.3 Reducing the number of Allegiant cameras

You need the Allegiant Master Control Software to edit the Allegiant file.

To reduce the number of Allegiant cameras:

1. Start the Master Control Software.
2. Open the Allegiant file.
3. Click the Camera tab.
4. Mark the cameras that are not required.
5. On the Edit menu, click Delete.
6. Save the file. The file size remains unchanged.
7. Repeat the last step for monitors that you do not need. Click the Monitors tab.
8. Import this file in Bosch Video Management System (see *Adding a device manually*, page 155).

36.4 Used ports

This section lists for all components of Bosch VMS the ports that must be open within a LAN. Do not open these ports to the Internet! For operation via Internet use secure connections like VPN or Remote Access.

Each table lists the local ports that must be open on the computer where the server is installed or on the router/level 3 switch that is connected to the hardware.

On a Windows 7 Firewall, configure an Inbound Rule for each open port.

Allow all outgoing connections for all Bosch VMS software applications.

Example for a simple Inbound Rule in Windows 7 Firewall

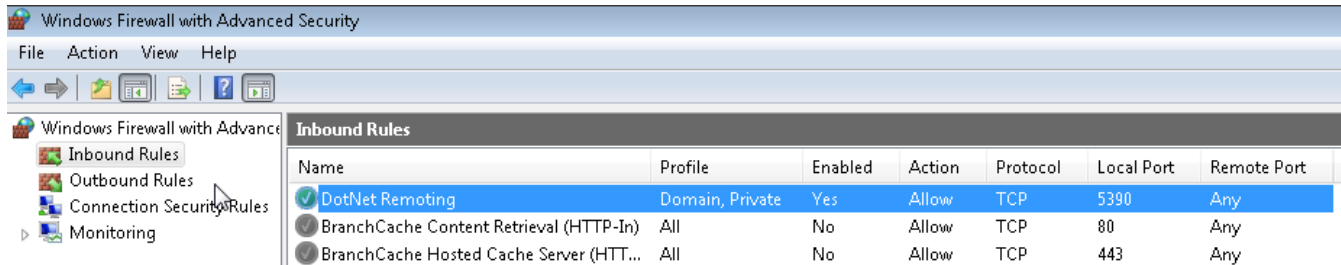

Management Server / Enterprise Management Server ports

Server (Listener)	Protocol	Inbound ports	Client (Requester)	Remark
Management Server	TCP	5390	Operator Client, Configuration Client, Bosch VMS SDK Application	.NET Remoting
Management Server	TCP	5392	Operator Client, Configuration Client, Mobile Video Service	WCF, gateway.push.apple.com
Management Server	TCP	5395	Configuration Client, Operator Client	User preferences, File transfer

Video Recording Manager ports

Server (Listener)	Protocol	Inbound ports	Client (Requester)	Remark
VRM	TCP	1756	Management Server, Configuration Client	via RCP+
VRM	UDP	1757	Management Server, Operator Client	Scan Target
VRM	UDP	1800	Management Server, Operator Client	Multicast Network Scan Target
VRM	TCP	80	Operator Client	VRM playback via http
VRM	TCP	443	Operator Client	VRM playback via https
VRM	TCP	5364, 5365	Operator Client	VRM eXport Wizard (project version)

Mobile Video Service ports

Server (Listener)	Protocol	Inbound ports	Client (Requester)	Remark
Mobile Video Service	TCP	80	Management Server, Operator Client, Configuration Client, HTML Client, Mobile Apps	Access via http
Mobile Video Service	TCP	443	Management Server, Operator Client, Configuration Client, HTML Client, Mobile Apps	Access via https
Mobile Video Service	TCP	2195	Apple Push Notification	Mac iOS
Mobile Video Service	UDP	1064-65535	Encoder, VRM	
Mobile Video Service transcoder	TCP	5382	Mobile Video Service mobile provider	Media stream
Mobile Video Service transcoder	TCP	5385	Mobile Video Service mobile provider	Media stream
Mobile Video Service Bosch VMS provider	TCP	5383	Operator Client	Media stream
Mobile Video Service mobile provider	TCP	5384	HTML Client, Mobile Apps	Media stream

iSCSI Storage System ports

Configure port forwarding at the connected router for this device.

Server (Listener)	Protocol	Inbound ports	Client (Requester)	Remark
iSCSI storage system	TCP	3260	Encoder, VRM, Configuration Client	

Bosch Video Streaming Gateway ports

Server (Listener)	Protocol	Inbound ports	Client (Requester)	Remark
Bosch Video Streaming Gateway	TCP	8756-8762	VRM, Management Server, Configuration Client	
Bosch Video Streaming Gateway	TCP	1756	VRM Configuration Client	via RCP+

Server (Listener)	Protocol	Inbound ports	Client (Requester)	Remark
Bosch Video Streaming Gateway	TCP	1757	VRM Configuration Client	Scan Target
Bosch Video Streaming Gateway	TCP	1758	VRM Configuration Client	Scan Response
Bosch Video Streaming Gateway	TCP	1800	VRM Configuration Client	Multicast Network Scan Target
Bosch Video Streaming Gateway	UDP	1064-65535	Encoder, VRM	

ONVIF camera ports

Configure port forwarding at the connected router for this device.

Server (Listener)	Protocol	Inbound ports	Client (Requester)	Remark
ONVIF camera	TCP	80	Management Server, VSG, Configuration Client, Operator Client	Access via http
ONVIF camera	RTSP	554	Management Server, VSG, Configuration Client, Operator Client	

Bosch VMS Operator Client / Cameo SDK ports

Server (Listener)	Protocol	Inbound ports	Client (Requester)	Remark
Operator Client	TCP	5394	Bosch VMS SDK Application, BIS	.NET Remoting
Operator Client	UDP	1024-65535	Encoder, VRM	
Operator Client	TCP	443	Encoder	Remote access, encrypted live view

Encoder ports

Configure port forwarding at the connected router for this device.

Server (Listener)	Protocol	Inbound ports	Client (Requester)	Remark
Encoder	TCP	1756	Decoder, Management Server, VRM, Operator Client, Configuration Client, Bosch VMS SDK Application	via RCP+
Encoder	UDP	1757	Decoder, Management Server, Operator Client	Scan Target

Server (Listener)	Protocol	Inbound ports	Client (Requester)	Remark
Encoder	UDP	1758	Decoder, Management Server, Operator Client	Scan Response
Encoder	UDP	1800	Decoder, Management Server, Operator Client	Multicast Network Scan Target
Encoder	TCP	80	Operator Client, Bosch VMS SDK Application, VSG	Access via http
Encoder	TCP	443	Operator Client, Bosch VMS SDK Application, VSG	Access via https

Bosch VMS Decoder ports

Configure port forwarding at the connected router for this device.

Server (Listener)	Protocol	Inbound ports	Client (Requester)	Remark
Decoder	TCP	1756	Management Server, Operator Client, Configuration Client, Bosch VMS SDK Application	via RCP+
Decoder	UDP	1757	Management Server, Operator Client	Scan Target
Decoder	UDP	1758	Management Server, Operator Client	Scan Response
Decoder	UDP	1800	Management Server, Operator Client	Multicast Network Scan Target
Decoder	TCP	80	Operator Client	Access via http
Decoder	TCP	443	Operator Client	Access via https
Decoder	UDP	1024-65535	Encoder	

DiBos/BRS ports

Server (Listener)	Protocol	Inbound ports	Client (Requester)	Remark
DiBos 8.7 / BRS 8.10	TCP	808	Management Server, Configuration Client	Web Service For DiBos v. 8.7 a patch is needed.
Alternative:				
DiBos / BRS	TCP	135	Operator Client, Management Server, Configuration Client	DCOM, used when Web Service does not work or the used DiBos version does not support Web Service Firewall must be disabled

Server (Listener)	Protocol	Inbound ports	Client (Requester)	Remark
DiBos / BRS	UDP	135	Operator Client, Management Server, Configuration Client	DCOM, used when Web Service does not work or the used DiBos version does not support Web Service Firewall must be disabled

DVR ports

Configure port forwarding at the connected router for this device.

Server (Listener)	Protocol	Inbound ports	Client (Requester)	Remark
DVR	TCP	80	Management Server, Configuration Client, Operator Client	Access via http

Barco Monitor Wall

Server (Listener)	Protocol	Inbound ports	Client (Requester)	Remark
Barco Monitor Wall	TCP	1756	Management Server, Operator Client, Configuration Client, Bosch VMS SDK Application	via RCP+
Barco Monitor Wall	UDP	1757	Management Server, Operator Client	Scan Target
Barco Monitor Wall	UDP	1758	Management Server, Operator Client	Scan Response
Barco Monitor Wall	UDP	1800	Management Server, Operator Client	Multicast Network Scan Target

VIDOS

Server (Listener)	Protocol	Inbound ports	Client (Requester)	Remark
VIDOS	TCP	1756	Encoder, Configuration Client	via RCP+
VIDOS	TCP	1757	Encoder	Scan Target
VIDOS	TCP	1758	Encoder	Scan Response
VIDOS	TCP	1800	Encoder	Multicast Network Scan Target

36.5 Enabling logging for ONVIF events

You can enable logging for ONVIF events for example when you encounter problems with receiving Bosch VMS events. Logging then helps you to find the issue.

To enable logging:

1. Open the file `%programfiles(x86)%\Bosch\VMS\AppData\Server\CentralServer\BVMSLogCfg.xml` in an appropriate editor, for example Notepad. Run the Notepad application as administrator.
2. Navigate to the line containing the following string:
Add logging for onvif events of a device by network address
The commented lines contain a brief explanation.
3. As the logger name, type in `OnvifEvents.<Networkaddress>`.
Type in only `OnvifEvents` to log the events for all ONVIF devices.
4. As level value, type in `DEBUG` for all incoming and outgoing events.
Type in `INFO` for all outgoing events.
Type in `WARN` or `ERROR` to disable.

The following lines show an example for logging the events from device 172.11.122.22 with all outgoing and incoming events:

```
<logger name="OnvifEvents.172.11.122.22" additivity="false">
<level value = "DEBUG"/>
<appender-ref ref="OnvifRollingFileAppender"/>
</logger>
```

See also

- *Configuring ONVIF events, page 152*
- *ONVIF events, page 61*

Glossary

802.1x

The IEEE 802.1x standard provides a general method for authentication and authorization in IEEE-802 networks. Authentication is carried out via the authenticator, which checks the transmitted authentication information using an authentication server (see RADIUS server) and approves or denies access to the offered services (LAN, VLAN or WLAN) accordingly.

Activation Key

Number that the user must enter to activate the purchased licenses. You receive the Activation Key after entering the Authorization Number in the Bosch Security System Software License Manager.

alarm

Event that is configured to create an alarm. This is a particular situation (motion detected, doorbell rung, signal lost, etc.) that requires immediate attention. An alarm can display live video, playback video, an action plan, a web page, or a map.

Alarm Image window

Image window for displaying one or more Alarm Image panes.

Alarm List

Window in Bosch Video Management System used to display a list of active alarms.

Allegiant

Bosch family of analog matrix switching systems.

analog monitor group

A set of analog monitors connected to decoders. The analog monitor group can be used for alarm processing in a given physical area. For example, an installation with three physically separated control rooms might have three monitor groups. The monitors in an analog monitor group are logically configured into rows and columns and can be set to full-screen or quad view.

analytics viewer

External application that is used for displaying video analytics alarms in Operator Client.

ANR

Automated Network Replenishment. Integrated process that copies missing video data from a video transceiver to the network video recorder after a network failure. The copied video data exactly fills the gap that occurred after the network failure. Hence the transceiver needs any kind of local storage. The recording capacity on this local storage is calculated with the following formula: $(\text{network bandwidth} \times \text{estimated network downtime} + \text{safety margin}) \times (1 + 1/\text{backup speed})$. The resulting recording capacity is required because the continuous recording must continue during the copy process.

area

A group of detection devices connected to the security system.

ASF

Advanced Systems Format; Microsoft Windows media audio and video format.

ATM

Automatic Teller Machine

Authorization Number

Number that you find in the Authorization Letter. You must enter the Authorization Number in the Bosch Security System Software License manager to obtain the Activation Key. Additionally you must enter the computer signature.

B-frame

Bidirectional frame. Part of a video compression method.

BIS

Building Integration System

bookmark

Used for storing a time period of live or recorded video. This allows for tagging particular scenes for later investigation. Additionally you can share your investigation results with other users by exporting a bookmark.

Bosch ATM/POS Bridge

Receives string via serial cable / COM interface and forwards these strings via Ethernet cable (TCP/IP). The strings are usually POS data or transactions from ATMs.

BRS

Bosch Recording Station. Video recording and management software.

CCL emulation

Emulation of the Command Console Language used for controlling an Allegiant matrix. You can use this set of commands to switch a Bosch VMS IP camera / encoder to a Bosch VMS IP decoder. You cannot control old analog cameras or the Allegiant matrix itself directly.

Command Script

Macro, that the administrator can program to build an automatic action like positioning a PTZ camera or send E-mails. For that functionality Bosch Video Management System provides a specific set of commands. Command Scripts are divided into Client Scripts and Server Scripts. Client Scripts are used on client workstations to execute certain tasks that can run on a client workstation. Server Scripts are executed automatically by an event that was triggered in the system. They get arguments provided by the event like date and time. A Command Script can consist of several scriptlets. You can create a Command Script using the following scripting languages: C#, VB.Net. Command Scripts are executed in response to events or alarms automatically according to a schedule (Server Scripts only), manually from the Logical Tree, or manually from icons or on maps.

Compound Event

Combination of different events. The combination uses Boolean expressions, i.e. AND and OR. You can combine only state changes, for example the change of a connection state to disconnected or the activation of a schedule.

debounce time

Time period starting with the occurrence of an event. During this time period usually no other event of the same type is accepted. This prevents for example that a switching sensor creates a large number of events. For events with several states, you can configure a different priority setting for each state. The following examples help you in getting a deeper understanding of the concept of debounce time. Example 1 deals with events creating the same state: The System Info

event occurs and the configured debounce time starts. During this time another System Info event occurs. This System Info event is not accepted as a new event. Example 2 deals with events creating different states with the same priority: A Motion Detected event occurs and the configured debounce time starts. During this time, the Motion Stopped event with the same priority occurs. The Motion Stopped event is not accepted as a new event. Example 3 also deals with events creating different states with the same priority: The state of a virtual input is on. The state priorities for both state changes are identical. At a specific point in time, the virtual input is switched off, the debounce time is started. During this debounce time the virtual input is switched on. This state change is not accepted as a new event because it has the same priority. After the debounce time has elapsed, the virtual input is in another state. The switch-on gets the time stamp of the end of the debounce time and no new debounce time starts. Example 4 deals with events with different priorities creating different states: The Motion Detected event occurs and the configured debounce time starts. During this time the Motion Stopped event with a higher priority occurs. The Motion Stopped event is accepted as a new event but the debounce time does not start again. Example 5 also deals with events with different priorities creating different states: The state of a virtual input is off. The state priority for switched on is "5", for switched off is "2". At a specific point in time, the virtual input is switched on (prio "5"), the debounce time is started. During this debounce time the virtual input is switched off (prio "2"). This state change is accepted as a new event because it has a higher priority. The debounce time of the first switch-on is continued. Further state changes are not accepted during this debounce time.

decoder

Changes a digital stream to an analog stream, e.g., to display digital video on a analog monitor.

Device Family

Bosch encoders / IP cameras can belong to one of the following device families: Device Family 1, Device Family 2, Device Family 3. Devices of Device Family 1 can only record stream 1. Devices

of Device Family 2 can record stream 1 or stream 2. Devices of Device Family 3 can record stream 1, stream 2 or I-Frame only.

Device Tree

Hierarchical list of all the available devices in the system.

dewarping

The use of software to convert a circular image from a fisheye lens with radial distortion to a rectilinear image for normal viewing (dewarping is the correction of distortion).

DNS

Domain Name System. A DNS server converts a URL (www.myDevice.com, for example) into an IP address on networks that use the TCP/IP protocol.

DTP

A DTP device (Data Transform Processor) transforms serial data of ATM devices to a defined data format and sends these data via Ethernet to Bosch VMS. You must ensure that a transformation filter is set on the DTP device. This task is performed with a separate software from the manufacturer of the DTP device.

dual authorization

Security policy that requires two different users to log on to the Operator Client. Both the users must be member of a normal Bosch Video Management System user group. This user group (or these user groups if the users are members of different user groups) must be part of a dual authorization group. A dual authorization group has its own access rights within Bosch Video Management System. This dual authorization group should have more access rights than the normal user group that the user belongs to. Example: User A is member of a user group called Group A. User B is member of Group B. Additionally a dual authorization group is configured with Group A and Group B as members. For the users of Group A, dual authorization is optional, for users of Group B it is mandatory. When user A logs on, a second dialog box for confirming the logon is displayed. In this dialog box, a second user can log on if he is available. If not, user A can continue and start the Operator Client. He then has only the access rights of Group A. When user B logs

on, again a second dialog box for logging on is displayed. In this dialog box, a second user must log on. If not, user B cannot start the Operator Client.

dual streaming

Dual streaming allows an incoming data stream to be encoded simultaneously according to two different, individually configured settings. This creates two data streams: one for live and pre-event recording, the other for continuous, motion, and alarm recording.

duplex

Term used to define the direction of data transmission between two parties. Half-duplex allows data transmission in both directions but not simultaneously. Full-duplex allows simultaneous data transmission.

DVR

Digital Video Recorder

dwel time

Preset amount of time a camera is displayed in an Image window until the next camera is displayed during a camera sequence.

DWF

Design Web Format. Used to display technical drawings on a computer monitor.

DynDNS

Dynamic Domain Name System. A DNS host service that holds IP addresses ready in a database. Dynamic DNS allows you to connect to the device via the Internet using the host name of the device. See DNS.

Edge dewarping

Dewarping performed in the camera itself.

Encoder

Changes an analog stream to a digital stream, e.g., to integrate analog cameras in a digital system like Bosch Video Management System. Some encoders can have a local storage like a flash card, a USB hard disk, or they can store their video data on iSCSI devices. IP cameras have an encoder built in.

Enterprise Access

Enterprise Access is a feature of Bosch VMS which consists of one or more Enterprise Accounts. Each Enterprise Account contains device permissions to devices of a particular Management Server.

Enterprise Account

Enterprise Account is an authorization that enables a user of Operator Client to connect to the devices of a Management Server being part of an Enterprise System. In an Enterprise Account, all permissions for the devices of this Management Server are configured. Operator Client can simultaneously connect to all Management Server computers that are part of this Enterprise System. This access is either controlled by the membership to an Enterprise User Group, and is controlled by the device permissions configured in the Enterprise Account for this Management Server.

Enterprise Management Server

Enterprise Management Server is a Bosch VMS Management Server hosting the configuration of Enterprise User groups. You need one or more Enterprise User Groups referring to one or more servers computers. The roles of Enterprise Management Server and Management Server can be combined in one configuration.

Enterprise System

Enterprise System is a feature of Bosch Video Management System that allows a user of Operator Client to access multiple Management Server computers simultaneously.

Enterprise User Group

Enterprise User Group is a user group that is configured on an Enterprise Management Server. Enterprise User Group defines the users that are authorized to access multiple Management Server computers simultaneously. Defines the operating permissions available for these users.

Event

A circumstance or state that is linked to an alarm and/or an action. Events can arise from many sources such as cameras, archivers, directories, digital inputs, etc. They can include start-recording states, loss of signal states, disk full messages, user logons, digital input triggers, etc.

face detection

Face detection is a software process that detects a face in a video image.

face recognition

Face recognition is a software process that compares a video image of a face with the faces stored in database. In case of a match, a message is issued.

Failover VRM

Software in the Bosch VMS environment. Takes over the task of the assigned Primary VRM or Secondary VRM in case of failure.

GSM

Global System for Mobile Communication. Standard for digital mobile phones.

H.264

Standard for encoding (compressing) digital audio and video for multimedia applications. This standard includes different profiles that can be manufacturer-dependent. The following profiles are available: Baseline, Baseline+, Main Profile. Baseline (not used in Bosch Video Management System) supports 2 CIF. Baseline+ supports 4 CIF and provides a better image quality than Baseline. Main Profile supports 4 CIF and provides a high efficient compression algorithm called CABAC (Context-adaptive binary arithmetic coding). This serves for high quality encoding for storage.

Hot spot

Mouse sensitive icon on a map. Hot spots are configured in Configuration Client. Hot spots can be for example cameras, relays, inputs. The operator uses it for localizing and selecting a device in a building. If configured, hot spots can display a blinking background color when a specific state event occurs.

I-frame

Intra frame. Part of a video compression method. Contains the information of a complete image, unlike P- or B-frames that contain information of the changes compared to the previous or next frame.

Image pane

Used for displaying live and recorded video of a single camera, a map, or an HTML file.

Image pane bar

Toolbar of an Image pane.

Image window

Container for Image panes, structured by an Image window pattern.

Instant playback

Plays the recorded image of the selected camera in an Image pane on the live screen. The start time (number of seconds in the past, or rewind time) can be configured.

Intelligent Tracking

Intelligent Tracking is a software process running on a camera that allows the camera to follow a selected object.

Intercom functionality

Used to talk on the loudspeakers of an encoder. This encoder must have audio-in and audio-out. The Intercom functionality can be granted per user group.

intrusion control panel

Generic name for the core device in a Bosch intrusion (burglary) security system. Keypads, modules, detectors, and other devices connect to the control panel.

IPS

Images per second. Number of video images transmitted or recorded per second.

IQN

iSCSI Qualified Name. The initiator name in IQN format is used for provisioning addresses for both iSCSI initiators and targets. With IQN mapping you create an initiator group that controls the access to the LUNs on an iSCSI target and you write the initiator names of each encoder and the VRM into this initiator group. Only the devices whose initiator names are added to an initiator group are permitted to access a LUN. See LUN and see iSCSI.

iSCSI

Internet Small Computer System Interface. Protocol that manages storage via a TCP/IP network. iSCSI enables access to stored data from everywhere in the network. Especially with the advent of Gigabit Ethernet, it has become affordable to attach iSCSI storage servers simply as remote hard disks to a computer network. In

iSCSI terminology, the server providing storage resources is called an iSCSI target, while the client connecting to the server and accessing the resources of the server is called iSCSI initiator.

JPEG

Joint Photographic Expert Group

JPEG

Joint Photographic Experts Group. Encoding process for still images.

LDAP

Lightweight Directory Access Protocol. Network protocol running over TCP / IP that allows accessing directories. A directory can be for example a list of user groups and their access rights. Bosch Video Management System uses it to get access to the same user groups as MS Windows or another enterprise user management system.

Live Mode**Logbook**

Container for logging all events in Bosch Video Management System.

Logical number

Logical numbers are unique IDs assigned to each device in the system for ease of reference. Logical numbers are only unique within a particular device type. Typical use of logical numbers are Command Scripts.

Logical Tree

Tree with a customized structure of all the devices. The Logical Tree is used in the Operator Client to select cameras and other devices. In the Configuration Client, the "Full Logical Tree" is configured (on the Maps and Structure page) and tailored for each user group (on the User Groups page).

LUN

Logical Unit Number. Used in the iSCSI environment to address an individual disk drive or a virtual partition (volume). The partition is part of a RAID disk array (the iSCSI target).

Management Server

Bosch VMS server managing devices.

Master Control Software

Software used as interface between Bosch Video Management System and an Allegiant device. Version 2.8 or greater is used.

MHT

Also called 'Web Archive'. File format that can save all HTML and image files of an Internet site in one file. To avoid problems we recommend to create MHT files with Internet Explorer 7.0 or higher only.

Mirrored VRM

Software in the Bosch VMS environment. Special case of a Secondary VRM. Ensures that the recording performed by a Primary VRMs is additionally and simultaneously performed to another iSCSI target with the same recording settings.

MOV

File extension of the default video format used by QuickTime Player from Apple.

MPEG-4

Motion Picture Expert Group. Standard for encoding (compressing) digital audio and video for multimedia applications.

MSS

Maximum Segment Size. The largest amount of data, specified in bytes, that a computer or communications device can handle in a single, unfragmented piece.

Multicast

Communication between a single transceiver and multiple receivers on a network by distribution of a single data stream on the network to a number of receivers in a defined group. Requirement for multicast operation is a multicast compliant network with implementation of the UDP protocol and the IGMP protocol.

Network monitoring

Measurement of network related values and evaluation of these values against configurable thresholds.

No-touch deployment

Method for automatic downloading, installing and running .NET applications without changing the registry or shared system components. With Bosch Video Management System, no-touch

deployment is used for updating the Operator Clients from the Management Server. The update takes place if a new version is stored on the Management Server and when each user is logging on to the Operator Client. If you work with one Operator Client against multiple Management Server computers, no-touch deployment uses only the software version stored on the Management Server where the Operator Client has last logged on successfully. When you try to log on to another Management Server with a different application version, this one displays the Management Server as not online because the software versions do not match.

number plate detection

Number plate detection is a software process that detects a number plate in a video image. This is for example used to count cars on a highway.

number plate recognition

Number plate recognition is a software process that compares a video image of a number plate with a list of number plates stored in a database. In case of a match, message is issued.

NVR

Bosch Network Video Recorder; computer in the Bosch Video Management System storing audio and video data, acting as Failover NVR, or as Redundant NVR. This NVR is different from the VIDOS NVR which can be integrated in Bosch Video Management System.

OID

Object Identifier. Term in the SNMP environment. Determines a MIB variable.

ONVIF

Open Network Video Interface Forum. Global standard for network video products. ONVIF conformant devices are able to exchange live video, audio, metadata, and control information and ensure that they are automatically discovered and connected to network applications such as video management systems.

Operator Client

Component of Bosch Video Management System that provides the user interface for system monitoring and operation.

Operator Client workstation

Computer in the Bosch Video Management System environment for viewing live and playback video and for configuration tasks. Operator Client is installed on this computer.

OSD

On-screen Display: Menus are shown on the display monitor.

Panoramic camera

Camera with a 360° or 180° view angle.

P-frame

Predicted frame. Part of a video compression method.

point

A detection device connected to the security system. Points show on the keypad individually and with custom text. The text might describe a single door, motion sensor, smoke detector, or an protected space such as UPSTAIRS or GARAGE.

Port

1) On computer and telecommunication devices, a port (noun) is generally a specific place for being physically connected to some other device, usually with a socket and plug of some kind. Typically, a personal computer is provided with one or more serial ports and usually one parallel port. 2) In programming, a port (noun) is a "logical connection place" and specifically, using the Internet protocol, TCP/IP, the way a client program specifies a particular server program on a computer in a network. Higher-level applications that use TCP/IP such as the Web protocol, Hypertext Transfer Protocol, have ports with preassigned numbers. These are known as "well-known ports" that have been assigned by the Internet Assigned Numbers Authority (IANA). Other application processes are given port numbers dynamically for each connection. When a service (server program) initially is started, it is said to bind to its designated port number. As any client program wants to use that server, it also must request to bind to the designated port number. Port numbers are from 0 to 65535. Ports 1 to 1023 are reserved for use by certain privileged services. For the HTTP service, port 80 is defined as a default and it does not have to be specified in the Uniform Resource Locator (URL).

Port mapping

Port mapping allows remote computers to connect to a specific computer or service within a private local area network (LAN).

POS

Point of sale.

Primary VRM

Synonym for VRM.

PTZ camera

Camera with pan, tilt, and zoom function.

RADIUS server

Remote Authentication Dial-In User Service: a client/server protocol for the authentication, authorization and accounting of users with dial-up connections on a computer network. RADIUS is the de-facto standard for central authentication of dial-up connections via Modem, ISDN, VPN, Wireless LAN (see 802.1x) and DSL.

RAID

Redundant array of independent disks. Used for organizing two or more hard disks as if they were one drive. On such a drive data is shared or replicated. This is used to achieve greater capacity, reliability, and speed.

RCP

Remote Control Protocol

Recording Schedule

Used for scheduling recording and for scheduling some events like starting backup or limiting log on. Recording Schedules cannot have gaps or overlaps. It also determines the video recording quality.

Reference image

A reference image is continuously compared with the current video image. If the current video image in the marked areas differs from the reference image, an alarm is triggered. This allows you to detect tampering that would otherwise not be detected, for example if the camera is turned.

Remote access

Remote access allows to connect different private networks to public networks. Multiple networks with private (local) network addresses can be accessed simultaneously or sequentially by Operator Client computers via public interfaces

(routers). Task of the router is to translate the incoming public network traffic to the corresponding private network address. The users of Operator Client can access Management Server or Enterprise Management Server and their devices via remote access.

Rewind time

Number of seconds in the past when an Image pane is switched to instant playback.

ROI

Region of Interest. Intended use of ROI is to save bandwidth when zooming into a section of the camera image with a fixed HD camera. This section behaves like a PTZ camera.

ROI

Region of Interest. Intended use of ROI is to save bandwidth when zooming into a section of the camera image with a fixed HD camera. This section behaves like a PTZ camera.

RTP

Real-Time Transport Protocol; a transmission protocol for real-time video and audio

RTSP

Real Time Streaming Protocol. A network protocol which allows to control the continuous transmission of audio-visual data or software over IP-based networks.

scopes

Scope is a term used in the field of ONVIF cameras. It is a parameter used for probing an ONVIF device. Usually the parameter contains a URI like the following: `onvif://www.onvif.org/<path>`. The parameter `<path>` can be for example `video_encoder` or `audio_encoder`. One ONVIF device can have multiple scopes. This URI denominates the task area of the device.

Secondary VRM

Software in the Bosch VMS environment. Ensures that the recording performed by one or multiple Primary VRMs is additionally and simultaneously performed to another iSCSI target. The recording settings can deviate from the settings of the Primary VRM.

Server Lookup

Access method for a user of Configuration Client or Operator Client to sequentially connect to multiple system access points. A system access point can be a Management Server or an Enterprise Management Server.

Skimming

Sabotage of a foyer card reader. A skimming device reads the card data of the magnetic stripe without the knowledge of the cardholder.

SNMP

Simple Network Management Protocol. IP based protocol that allows to get information from networking devices (GET), to set parameters on network devices (SET) and to be notified about certain events (EVENT).

SNTP

Simple Network Time Protocol is a simplified version of NTP (see NTP). SNTP can be used when the ultimate performance of the full NTP implementation described in RFC 1305 is not needed or justified. SNTP version 4 is described in RFC 2030 (see RFC).

Task Schedule

Used for scheduling events which can occur in Bosch Video Management System, for example executing a Command Script. In Events you assign Task Schedules to events. For scheduling events you can also use Recording Schedules. With a standard Task Schedule you configure time periods for every day of the week, for holidays, and for exception days. With a recurring Task Schedule you configure recurring time periods. They can recur every day, every week, every month, or every year.

TCP

Transmission Control Protocol

TCP/IP

Transmission Control Protocol / Internet Protocol. Also known as Internet protocol suite. Set of communication protocols used to transmit data over an IP network.

Text data

Data of a POS or ATM like date and time or bank account number stored with the corresponding video data to provide additional information for evaluation.

Timeline

Part of the Bosch Video Management System user interface. Displays lines as graphical representations of the recordings of the selected cameras. The Timeline allows you to navigate through recorded videos.

Trap

Term in the SNMP environment for an unrequested message from a monitored device (agent) to the network monitoring system (manager) about an event in this device.

Trunk line

Analog outputs of an analog matrix that are connected to an encoder device. Thereby matrix video sources can be used in the Bosch Video Management System.

UDP

User Datagram Protocol. A connection less protocol used to exchange data over an IP network. UDP is more efficient than TCP for video transmission because of lower overhead.

unmanaged site

Item of the Device Tree in Bosch VMS that can contain video network devices like Digital Video Recorders. These devices are not managed by the Management Server of your system. The user of Operator Client can connect to the devices of an unmanaged site on demand.

URI

Uniform Resource Identifier. String for identifying a network resource. Each URI consists of scheme, authority, path, query, fragment. Only scheme and fragment are mandatory for Mobile Video Service. Example: `http:<scheme>//example.com<authority>/over/therepath?name=ferret<query>#nose<fragment>`

URL

Uniform Resource Locator

User group

User groups are used to define common user attributes, such as permissions, privileges and PTZ priority. By becoming a member of a group, a user automatically inherits all the attributes of the group.

VCA

Video content analysis: computer analysis of video streams to determine what is happening at the scene being monitored. See also Intelligent Video Analytics

Video Analytics

Video analytics is a software process that compares a camera image with the stored images of specific persons or objects. In case of a match, the software triggers an alarm.

Video resolution

Specification of horizontal and vertical pixels transferred with video signals. PAL: 1CIF = 352 x 288 2CIF = 704 x 288 4CIF = 704 x 576 QCIF = 176 x 144 NTSC 1CIF = 352 x 240 2CIF = 704 x 240 4CIF = 704 x 480 QCIF = 176 x 120 HD 720p = encoded 1280 x 720 1080p = encoded 1920 x 1080

Video Streaming Gateway (VSG)

Virtual device that allows integrating Bosch cameras, ONVIF cameras, JPEG cameras, RTSP encoders.

VIDOS NVR

VIDOS Network Video Recorder. Software that stores the audio and video data of IP encoders on a RAID 5 disk array or any other storage medium. VIDOS NVR provides functions for playback and retrieval of the recorded video. You can integrate cameras in your Bosch Video Management System that are connected to a VIDOS NVR computer.

Virtual input

Used for forwarding events from third-party systems to Bosch Video Management System.

VRM

Video Recording Manager. Software package in Bosch Video Management System which manages storing video (MPEG-4 SH++ and H.264) with audio data and metadata on iSCSI devices in the network. VRM maintains a database containing the recording source information and a list of

associated iSCSI drives. VRM is realized as a service running on a computer in the Bosch Video Management System network. VRM does not store video data itself but distributes storage capacities on iSCSI devices to the encoders, while handling load balancing between multiple iSCSI devices. VRM streams playback from iSCSI to Operator Clients.

WAN

Wide Area Network.

Workstation

In the Bosch VMS environment: A dedicated computer where Operator Client is installed. This computer is configured as a workstation in Configuration Client to enable specific functions.

Index

A

access denied			
Allegiant CCL emulation	264		
accessing the Help	16		
acquire PTZ control	215		
activate	216		
Bosch Video Management System	99		
previous configuration	217		
activation	100, 219		
configuration	216		
delayed	216, 226		
Activation Key	228, 321		
Adaptive Bit Rate	316		
add Bosch Allegiant input alarm	221		
add Bosch ATM/POS bridge	220		
add BVIP decoder	156		
add BVIP encoder	54, 156, 246, 248, 274, 275		
add encoder	84, 135, 169		
add pool			
VRM	128		
add text data to continuous recording	363		
add unmanaged site	123, 124, 287		
add video analytics device	167, 174, 267		
add VRM	83, 125		
additional data			
text data	57		
AE-response speed	302		
alarm	295		
alarm map	365		
alarm message	296		
alarm priority	215		
alarm recording	202, 203, 365		
alarm recording mode	190, 353		
alarm recording time (NVR)	365		
alarm sequence	202, 365		
alarms			
sort order	365		
Allegiant			
CCL emulation	155, 166		
control channel	78, 80		
firmware version	71, 72		
Network Host program	79		
PTZ camera	352		
Satellite System	80		
too many cameras	389		
Allegiant CCL commands	80		
Allegiant CCL emulation	58		
access denied	264		
Allegiant CCL Emulation page	264		
Allegiant file	389		
Allegiant matrix	155, 162, 241		
all-in-one system	26		
analog matrix	241		
analog monitor group	19, 155, 157, 163, 229, 245, 250, 251, 365, 368		
add	157		
controlled by workstations	163		
default	157		
initial camera	163		
OSD	163		
quad view	163		
single view	163		
startup camera	163		
analytics viewer	69, 173		
ANR	107, 142, 352		
ANSI	35		
ASF	382		
aspect ratio 16/9	212		
ATM POS device	155		
Audio Intercom functionality	382		
Authorization Number	228		
automatic alarm popup behavior	52		
automatic display of alarms	52		
automatic logoff	230		
automatic recording mode	273		
automatic relogon	216		
automatic restart	216		
B			
backlight compensation	302		
basic configuration	130		
blinking device icons	204, 360		
Bosch IntuiKey keyboard	71, 72, 73, 75, 155, 160, 243, 262		
Bosch Script API help	205		
Bosch Video Management System	19		
activate	99		
GUI language	388		
licensing	99		
Online Help	16		
overview	19		
update	387		
BVIP decoder	105, 139		
add	156		
BVIP device			
password	141, 290		
Web page	290		

BVIP encoder	105, 139	copy and paste	188
add	54, 156, 246, 274	crash	
BVIP encoder:add	248, 275	Configuration Client	389
bypass		Operator Client	389
point	383	create	
C		Command Script	205
CABAC	357	customized events	199, 359
camera round	342	D	
camera round	177, 345	data sheet	21
camera sequence	342	DCZ keyboard	158, 262
camera sequence	177, 345	decoder	
CCL emulation	166	Bosch IntuiKey keyboard	160
CCTV keyboard	158	decoder:destination password	141
connection loss	388	decoupled	58
change IP address	140, 162, 236, 237	default analog monitor group	157
change network address	140, 162	default configuration	130
change password	133, 141, 290, 373	default IP address	236
change pool	277	default password	216, 227
Changes in light level	313	default stream	243, 351
CHAP password	271	delayed activation	216, 226
character encoding	35	delete user	373
chattering sensors	201	destination password	141
Client Command Script		device capabilities	
alarm accepted	368	update	105, 139
executed on startup	162, 206, 207	device identification	291
CLL commands	58	device monitor	219
codecs	190	device name	291
Command Script	342	device replacement	101, 102
Bosch Script API help	205	Device Tree	234, 342
export	206	Devices pane	342
import	206	devices without password protection	216
Command Script	177	DiBos	
Commercial Type Number	227	version	71, 72
Compatibility Mode	61	DiBos device	155
Compound Events	199, 359	digital keyboard	158
configuration data		digital video recorder	155
export	217	disable enforced password protection	227
configuration data to OPC		disconnected	58
export	218	dome camera	193, 357
Configuration Wizard		DSA E-Series	129, 278
Mobile Video Service	26	DTP3N	258
configure VRM recording	221	dual authorization	374, 375
connecting		dual recording	40, 133, 194
Allegiant matrix and Bosch VMS	76	dual streaming	244
Bosch IntuiKey keyboard and Bosch VMS	73	duplicate IP addresses	236
connection string	230	duplicating an event	198
control of a camera	190, 222	DVR device	53
		DynDNS	35

E			
E-mail device		155	
empty password		216	
encoder			
add		84, 135, 169	
Web page		290	
encoder:failover recording mode		139	
encoding on NVRs		234	
enforced password protection		227	
Enterprise Management Server		386	
Enterprise System		26, 109, 114, 119	
examples		220	
add Bosch Allegiant input alarm		221	
add Bosch ATM/POS bridge		220	
configure VRM recording		221	
exception days		185	
export			
ASF		382	
Camera Table		189	
Command Script		206	
configuration data		217	
configuration data to OPC		218	
export Server List		35	
F			
face detection		68	
face recognition		68	
failover recording mode		272	
encoder		139	
Failover VRM		40, 127, 268	
False alarms		313	
filtering		234, 237, 343, 350, 359, 362, 364, 371	
finding			
devices		234, 237, 343, 350, 359, 362, 364, 371	
information in the Help		16	
fire detection camera		168	
Firewall		284	
firmware upgrade			
Bosch IntuiKey keyboard		75	
Forensic Search		163, 222, 243, 244	
G			
gain control		303	
Ganetec			
analytics viewer		69, 173	
global alarm settings		201	
global default password		97, 216, 227	
GUI language		388	
H			
H.264		357	
H.264 deblocking filter		357	
HD cameras		212	
help		16	
holidays		185	
hot spots		342	
HTML files		342	
I			
I/O modules		155	
identification		291	
import			
Command Script		206	
resource files		176	
inactivity		230	
Independent Operator Client		58	
initial camera		251	
Initiator extension		292	
Initiator name		292	
Intercom functionality		382	
interface settings			
VIP XD		160	
intrusion panel		266	
IntuiKey keyboard		158	
IP address			
change		140, 162, 236, 237	
duplicates		236	
iPad		167, 265	
iPhone		167, 265	
IQN mapping		130	
iSCSI device		130	
iSCSI password		271	
iSCSI storage pool		38, 269	
iSCSI storage system		38	
K			
KBD Universal XF keyboard		71, 72, 155, 243	
L			
language		388	
Configuration Client		229	
Operator Client		372	
large LUN		129, 132, 273, 281	
Large LUNs		273	
license		100	
Licenses		321	
licensing			
Bosch Video Management System		99	
Config Wizard		97	
Stratus server		99	
link to map		180	
log file information		309	
Logbook database		230	
connection string		230	

Logging	198, 201, 272	permissions	175, 342
logging ONVIF events	394	point	
Logical Tree	175, 368	bypass	383
LUNS		pool	
larger than 2 TB	273	change	277
M		move device	131, 136, 149
malfunction relay	56	VRM	128, 277
Management Server	21, 26, 58	pooling	38, 269
manual recording	61, 202, 365	port forwarding	35
manual recording time (NVR)	365	port mapping	35, 230
map		post-alarm time	353
blinking hot spots	204, 360	post-event time	190, 353
map link	180	post-event time	355
maps	342	pre-alarm time	353
menu commands	224	pre-event time	190, 353
MIC IP 7000	172	pre-event time	355
Mobile Video Service	26, 54	previous configuration	217
move device	131, 136, 149	Primary Failover VRM	127
multi monitor mode	212	Primary VRM	40, 126, 268
multicast	284	printing the Help	16
multi-select	175	profile	356
N		protect alarm recording	203
network address		PTZ blocking	215, 377, 384
change	140, 162	PTZ camera	193, 357
network monitoring device	155	Allegiant	352
network scan	236	PTZ control	
new DiBos devices	160, 161, 240	blocking	215, 377, 384
night mode	303	push-to-talk	382
no password	216	Q	
noise reduction	303	quad view	163, 251
number plate detection	68	R	
number plate recognition	68	RAM recording	353
NVR	21	recording mode	
O		automatic	273
offline	58, 373	failover	272
Offline Mode	58	Recording preferences	294
online application Help	16	recording quality	356
ONVIF logging	394	recording settings	23
ONVIF Media profile	351	Recording Table	350
OPC Server	387	redundant recording	40
Operator Client	19, 175	Redundant VRM	40, 127, 268
P		Reflections of light	313
panoramic camera		refresh states	224, 237
viewing modes	62	Region of Interest	55, 193, 351, 376
password	141, 290	relay	
password change	133, 141, 290, 373	malfunction	56
password missing	216	Release Notes	21
peripheral device	155	remote access	35, 110, 115, 119, 121, 230
		Remote export	61

remove prepositions	193	synchronization	107
remove user	373	synchronize	
replace content	176	VRM configuration	125, 269
resource files		system requirements	21
import	176	T	
resource files	176	Target data rate	356
ROI	55, 193, 351, 376	time	295
routed access	235	time server	107
S		time synchronization	107
scan		time zone	18, 31, 287, 288
across subnets	229	too many Allegiant cameras	389
encoders	268	transcoding service	167, 265
in subnets	229	trigger text data recording	203
live only encoders	268	U	
local storage encoders	268	UHD cameras	244
VRM	268	unreliable network	265
scan for conflicting IP addresses	236	update	387
scan network	236	device capabilities	105, 139
scheduled recording settings	23	user	
Secondary Failover VRM	127	delete	373
secondary recording	133, 194	remove	373
Secondary VRM	40, 126, 268	user event button	198, 199
sequence	345	UTF-8	35
Server ID	102	V	
Server initiator name	271	VCA	311
Server List		verify authenticity	146
add columns	110, 115, 119, 121	video analytics	68, 173, 266
csv export	35	Video Streaming Gateway	155
delete columns	110, 115, 119, 121	VIDEOJET 7000 connect	172
Server Lookup	121	VIDOS NVR	86, 159
Server Network	123, 124, 287, 288	viewing modes of panoramic camera	62
sharpness	304	VIP X1600 XFM4	357
shutter	304	VIP XD	71
silence bells	383	half-duplex mode	160
SMS device	155	interface settings	160
SNMP settings	232	quad view	163
SNMP traps		virtual input	155
get	232	VPN	35
send	232	VRM	
software package	100	add	83, 125
software update	387	add pool	128
sort order		Failover	40, 127, 268
alarms	365	pool	128, 277
states	224, 237	Primary	40, 126, 268
status	219	Primary Failover	127
Stratus server		Redundant	40, 127, 268
licensing	99	Secondary	40, 126, 268
stream	351, 354	Secondary Failover	127
switch off alarm sirens	383	VRM 3.50	125, 269

VRM storage pool	38, 269
W	
WAN	35, 230
Web client	167
WLAN	167, 265
workstation	163, 229

Bosch Sicherheitssysteme GmbH

Robert-Bosch-Ring 5

85630 Grasbrunn

Germany

www.boschsecurity.com

© Bosch Sicherheitssysteme GmbH, 2016