



# ND9312

H.265 8CH Embedded NVR

H.265 • 4K Display • Fisheye Dewarp • Web Plugin Free •  
VIVOCloud • Trend Micro IoT Security • ONVIF

- H.265 Compression Technology
- Up to 8 Channel IP Camera Input
- HDMI Video Output up to 4K Resolution
- 1 x 3.5" SATA HDD
- Up to 8MP Camera Live View and Playback
- Crowd Control Solution
- Trend Micro IoT Security
- Multiple Browsers Supported: IE, Chrome, and Firefox on both Windows & macOS
- Live and Playback Fisheye Dewarp
- VIVOCloud App & Portal for 24/7 Viewing
- Compact Size with Fanless Design



## Highlight Features

### Crowd Control Solution

VIVOTEK Crowd Control Solutions can easily monitor the number of people entering and exiting a store, thereby providing customers and staff with a safer environment. This solution can be deployed at points of entry to areas with a higher likelihood of social interaction such as shops, supermarkets, pharmacies, banks, and restaurants.

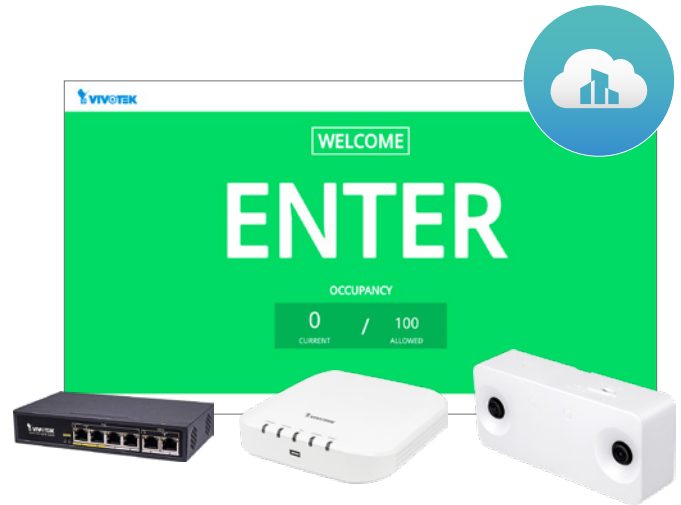

### Better Video Quality with Lower Bandwidth

With H.265 standard and VIVOTEK's Smart Stream technology, VIVOTEK NVR is not only able to provide the high quality video, also save the usage of network bandwidth and recording capacity more than regular H.264 standard.

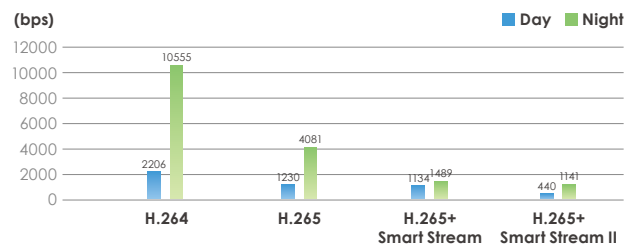

### 4K IP Camera Video Input and 4K Local Video Output

Supporting 4K IP camera video input and 4K local video output, VIVOTEK's NVR can provide users extra high definition video resolution ensuring they will never miss a single detail in both video monitoring and recording.



4K Resolution

### Fisheye Dewarp

VIVOTEK's NVR offers both LiveView and Playback modes for one fisheye network camera simultaneously. They also provide multiple fisheye de-warp display modes, including 1O, 1P, 1R, 1O3R, 1O8R, allowing users to monitor any angle, or to enjoy precise detailed images for a total surveillance experience.

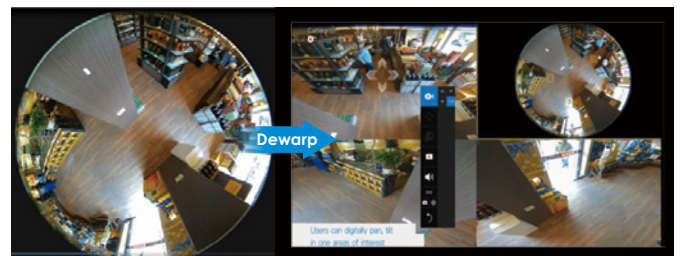

### Chrome & Firefox Now Supported

Support for plug-in free web browsers enables users with direct web viewing/setting on IE, and now also on Chrome and Firefox web browsers, for both Windows and macOS.



## Highlight Features

### Trend Micro IoT Security

In collaboration with industry-leading cybersecurity software partners, VIVOTEK focuses on making network security products and software that meet industry protocols as well as constantly developing shields to increase your protection from various cyberattacks. By choosing VIVOTEK solutions, users can experience not only high-quality products, but also safer network environments.



### VIVOCLOUD App & Portal for 24/7 Viewing

The free VIVOCLOUD app makes surveillance lightweight and portable, ensuring efficient operation. The latest P2P technology makes remote access even more convenient, by simply scanning the QR-code and installing the app, users can view live streams and play recorded clips with the intuitive interface anytime, anywhere. Armed with the Push Notification function, users will directly get an alert message on their Android/iOS mobile device and directly playback the video to check for any suspicious activity.

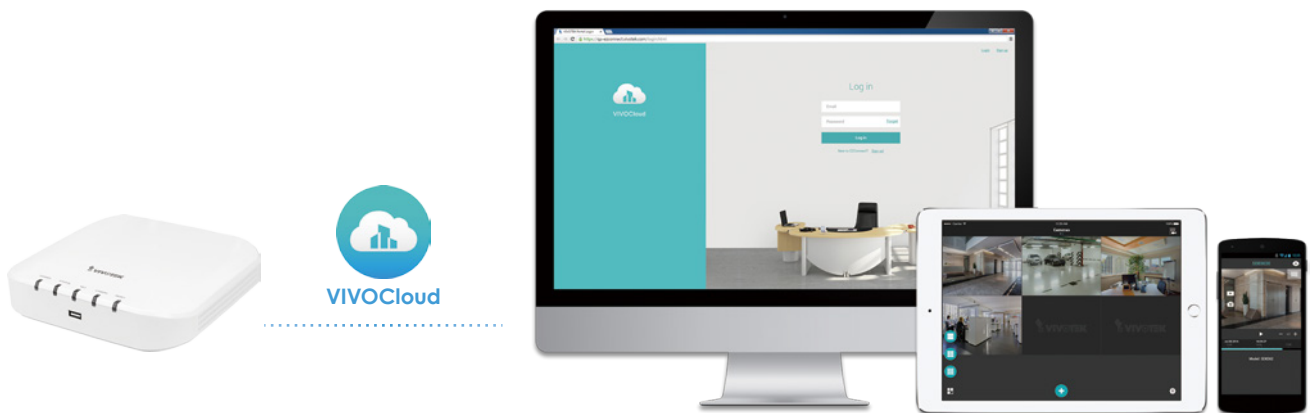

## Highlight Features

### Easy Connection with IP Cameras and Quick Auto Setup

In order to provide users a highly intuitive experience, it allows for the IP cameras' positions and connects to the NVR without entering long passphrases. Auto Setup Wizard then conveniently sets up a centralized configuration to reduce connection times to within 2 minutes.

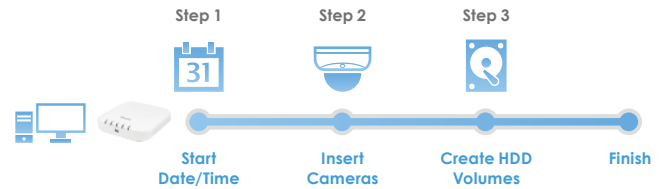

## System Structure

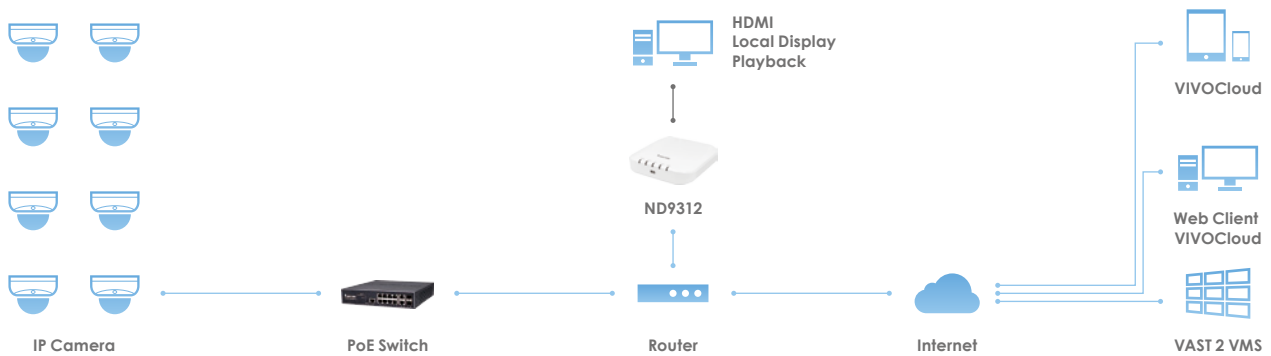

## Technical Specifications

Model	ND9312
<b>Device</b>	
OS	Embedded Linux
CPU	ARM Processor
Flash	256 MB
RAM	1GB
Watchdog	Hardware + Software
Power Restoration	System restart automatically after power recovery
<b>Local Display</b>	
Live View Display	8 Channels Multi-layout display: 1x1, 3V, 2x2, 3x3, 1P+3, 2P+3, 1M+5, 1P+6

## Technical Specifications

Video Output	HDMI x1
Display Resolution	3840x2160,1920x1080, 1280x720
Camera Position	Change the viewcell position on the live view screens
Stream Application	Constant\Auto adaptive stream
Monitor Enhancement	OSD display (NVR), OSD display (camera), camera information, remote I/O control, event notification, aspect ratio
Fisheye Dewarp	10, 1P, 1R, 103R, 108R
PTZ Operation	Direction control, home, iris, preset, patrol (group), PiP control

### Video

Video Format	H.265, H.264, MJPEG
Graphic Decoder	Hardware decoding
Decoding Resolution	Up to 3840x2160
Decoding Capability	3840x2160 @ 30 fps (1CH) 1920x1080 @ 120 fps (4CH) 1280x720 @ 240 fps (8CH)

### Audio

Audio Format	G.711, G.726
Audio In/Out	HDMI with audio out

### Record

Recording Time (sec.)	Pre-Record: 5 (Max. 10) Post-Record: 20 (Max. 300)
Recording Stream	Single
Recording Throughput	48 Mbps
Recording Mode	Continuous, schedule, manual, event, activity adaptive streaming
Recording Setting	Recycle (unit: day)
Watermark	Supported

### Storage & Backup

HDD Devices	Internal x1 (3.5")
HDD Max. Capacity	* Please refer to HDD supported list on the VIVOTEK website.
Disk Management	Create, format and remove disk HDD S.M.A.R.T.
Video Clip Export	USB dongle (FAT format)
Schedule Backup	FTP

### Playback

Playback Display	4 Channels Multi-layout display: 1x1,2x2,1P+3,1V+3
Playback Control	Regular (play, pause, stop), rewind, next /previous frame, speed control, calendar, event, timeline, timeline scale, thumbnail (storyboard)

# Technical Specifications

Video Search	By calendar, date/time, alarm
Thumbnail Explorer (Storyboard)	Listing the thumbnail of recorded video (Max. 2 CH)
Snapshot	JPEG
Video Clip Export	EXE
<b>Network</b>	
Ethernet	10/100Mbps Ethernet (RJ-45) x 1
Video Throughput for Remote Client	40 Mbps
Protocols	IPv4, TCP/IP, HTTP, HTTPS, UPnP, RTSP/RTP/RTCP, SMTP, FTP, DHCP, NTP, DNS, DDNS, IP Filter
<b>External Interface</b>	
USB	USB 2.0 x 2 (front x1, back x1)
Audio	HDMI with audio out
<b>System</b>	
Camera Integration	ONVIF Profile S
Event	Motion detection, PIR detection, tampering detection, camera DI/DO, camera disconnected, disk failure, disk full
Event Action	Record, email (text/snapshot), FTP, buzzer, ePTZ control (go to preset), camera DO, send to CMS, VIVOCLOUD APP notification
User Management	User level: administrator, regular user
Log	System, recording, user, error
Date&Time	Time zone, manual, automatic sync NTP, daylight saving time
Language	Czech, English, French, German, Italian, Japanese, Korean, Portuguese, Polish, Russian, Spanish, Simplified Chinese, Traditional Chinese
<b>Advance Features</b>	
Trend Micro IoT Security	Supported
Crowd Control Solution	Supported
<b>Remote Client</b>	
Software AP	Shepherd, VAST 2
Mobile/Tablet App	iViewer (Android & iOS)
Web Browser	Internet Explorer 10 (32 bit) or later / Windows Chrome v68.0.3 & Firefox v61.0.2 or later / Windows & macOS
VIVOCLOUD	Supported
<b>General</b>	
Power Input	DC 12V 3A
Power Consumption	Max. 15W
Dimensions	198 (W) x 200 (D) x 47(H) mm
Weight	530 g (Without HDD)

## Technical Specifications

Operating Temperature	0°C ~ 40°C (32°F ~ 104°F)
Humidity	0 ~ 95%
Safety Certifications	CE, LVD, FCC, VCCI, C-Tick, UL
Warranty	36 months

## Dimensions

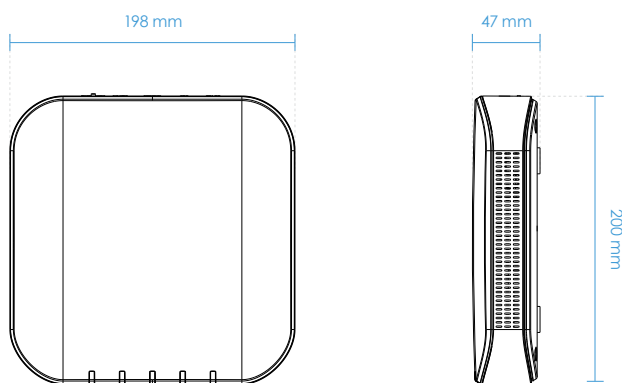

## Mechanical Information

Front View

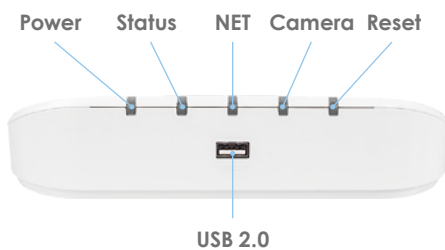

Back View

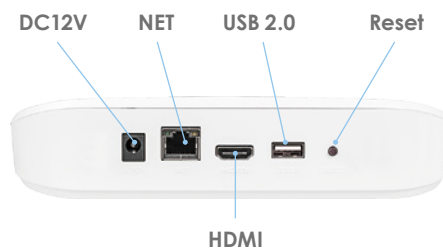

## Ordering Information

Model	Description	P/N
ND9312	H.265, 8CH, 1HDD NVR	100218100G, US
		100218110G, EU
		100218120G, UK
		100218130G, AU
		100218140G, JP